

-- STATE OF NORTH CAROLINA--
DEPARTMENT OF TRANSPORTATION
RALEIGH, N.C.

SECOND INDUSTRY DRAFT RFP



DESIGN-BUILD PROJECT

TIP I-2304AD

October 20, 2010



VOID FOR BIDDING

DATE AND TIME OF TECHNICAL AND PRICE PROPOSAL SUBMISSION: **December 22, 2010 BY 4:00 PM**

DATE AND TIME OF PRICE PROPOSAL OPENING: **January 18, 2011 AT 2:00 PM**

CONTRACT ID: C 202382

WBS ELEMENT NO.: 34156.3.6

COUNTY: DAVIDSON

ROUTE NO.: I-85

MILES: 3.59

LOCATION: RECONSTRUCTION OF I-85 FROM NORTH OF NC 150 TO JUST NORTH OF I-85
BUSINESS

TYPE OF WORK: DESIGN-BUILD AS SPECIFIED IN THE SCOPE OF WORK
CONTAINED IN THE REQUEST FOR PROPOSALS

NOTICE:

ALL PROPOSERS SHALL COMPLY WITH ALL APPLICABLE LAWS REGULATING THE PRACTICE OF GENERAL CONTRACTING AS CONTAINED IN CHAPTER 87 OF THE GENERAL STATUTES OF NORTH CAROLINA WHICH REQUIRES THE PROPOSER TO BE LICENSED BY THE N.C. LICENSING BOARD FOR CONTRACTORS WHEN BIDDING ON ANY NON-FEDERAL AID PROJECT WHERE THE BID IS \$30,000 OR MORE, EXCEPT FOR CERTAIN SPECIALTY WORK AS DETERMINED BY THE LICENSING BOARD. PROPOSERS SHALL ALSO COMPLY WITH ALL OTHER APPLICABLE LAWS REGULATING THE PRACTICES OF ELECTRICAL, PLUMBING, HEATING AND AIR CONDITIONING AND REFRIGERATION CONTRACTING AS CONTAINED IN CHAPTER 87 OF THE GENERAL STATUTES OF NORTH CAROLINA. NOT WITHSTANDING THESE LIMITATIONS ON BIDDING, THE PROPOSER WHO IS AWARDED ANY PROJECT SHALL COMPLY WITH CHAPTER 87 OF THE GENERAL STATUTES OF NORTH CAROLINA FOR LICENSING REQUIREMENTS WITHIN 60 CALENDAR DAYS OF BID OPENING, REGARDLESS OF FUNDING SOURCES.

5% BID BOND OR BID DEPOSIT REQUIRED

**PROPOSAL FORM FOR THE CONSTRUCTION OF CONTRACT NO. C202382
IN DAVIDSON COUNTY, NORTH CAROLINA**

Date _____ 20 _____

**DEPARTMENT OF TRANSPORTATION,
RALEIGH, NORTH CAROLINA**

The Design-Build Team herein acknowledges that it has carefully examined the location of the proposed work to be known as Contract No. C202382; has carefully examined the Final Request for Proposals (RFP) and all addendums thereto, specifications, special provisions, the form of contract, and the forms of contract payment bond and contract performance bonds, which are acknowledged to be part of the Contract; and thoroughly understands the stipulations, requirements and provisions. The undersigned Design-Build Team agrees to be bound upon their execution of the Contract and including any subsequent award to them by the Board of Transportation in accordance with this Contract to provide the necessary contract payment bond and contract performance bond within fourteen calendar days after the written notice of award is received by them.

The undersigned Design-Build Team further agrees to provide all necessary materials, machinery, implements, appliances, tools, labor, and other means of construction, except as otherwise noted, to perform all the work and required labor to design, construct and complete all the work necessary for State Highway Contract No. C202382 in Davidson County by no later than the dates(s) specified in the Final RFP or Technical Proposal, whichever is earlier, and in accordance with the requirements of the Engineer, the Final RFP, the 2006 *Standard Specifications for Roads and Structures*, specifications prepared by the Department, the Technical Proposal prepared by the Design-Build Team, at the lump sum price(s) bid by the Design-Build Team in their Price Proposal.

The Design-Build Team shall provide signed and sealed documents prepared by the Design-Build Team, which specifications and plans show the details covering this project and adhere to the items noted above.

The Design-Build Team acknowledges that project documents furnished by the Department are preliminary and provided solely to assist the Design-Build Team in the development of the project design. Unless otherwise noted herein, the Department does not warrant or guarantee the sufficiency or accuracy of any information furnished by the Department.

The Department does not warrant or guarantee the sufficiency or accuracy of any investigations made, nor the interpretations made or opinions of the Department as to the type of materials and conditions to be encountered at the project site. The Design-Build Team is advised to make such independent investigations, as they deem necessary to satisfy their self as to conditions to be encountered on this project. The Design-Build Team shall have no claim for additional compensation or for an extension of contract time for any reason resulting from the actual conditions encountered at the site differing from those indicated in any of the information or documents furnished by the Department except as may be allowed under the provisions of the Standard Specifications.

Although the Department has furnished preliminary designs for this project, unless otherwise noted herein, the Design-Build Team shall assume full responsibility, including liability, for the

project design, including the use of portions of the Department design, modification of such design, or other designs as may be submitted by the Design-Build Team.

The Design-Build Team shall be fully and totally responsible for the accuracy and completeness of all work performed under this contract, and shall indemnify and hold the Department harmless for any additional costs and all claims against the Department or the State which may arise due to errors or omissions of the Department in furnishing the preliminary project designs and information, and of the Design-Build Team in performing the work.

The published volume entitled North Carolina Department of Transportation, Raleigh, *Standard Specifications for Roads and Structures*, JULY 2006, as well as, all design manuals, policy and procedures manuals, and AASHTO publications and guidelines referenced in the Request For Proposals, with all amendments and supplements thereto, are by reference, incorporated and made part of this contract; that, except as herein modified, all the design, construction and Construction Engineering Inspection included in this contract is to be done in accordance with the documents noted above and under the direction of the Engineer.

If the Design-Build Proposal is accepted and the award is made, the Technical Proposal submitted by the Design-Build Team is by reference, incorporated and made part of this contract. The contract is valid only when signed either by the Contract Officer or such other person as may be designated by the Secretary to sign for the Department of Transportation. The conditions and provisions herein cannot be changed except by written approval as allowed by the Request for Proposals.

Accompanying the Design-Build Proposal shall be a bid bond secured by a corporate surety, or certified check payable to the order of the Department of Transportation, for five percent of the total bid price, which deposit is to be forfeited as liquidated damages in case this bid is accepted and the Design-Build Team shall fail to provide the required payment and performance bonds with the Department of Transportation, under the condition of this proposal, within 14 calendar days after the written notice of award is received by them, as provided in the Standard Specifications; otherwise said deposit will be returned to the Design-Build Team.

**TO
BE
SEALED
IN
FINAL
RFP**

*Transportation Program
Management Director*

**TO
BE
SEALED
IN
FINAL
RFP**

State Contract Officer

TABLE OF CONTENTS

COVER SHEET

PROPOSAL SHEETS

PROJECT SPECIAL PROVISIONS	<small>(GREEN SHEETS)</small>	<i>PAGE NO.</i>
Contract Time and Liquidated Damages		1
Other Liquidated Damages		1
Progress Schedule		2
Payout Schedule		3
Mobilization		4
Substantial Completion.....		4
Submittal of Quantities, Fuel Base Index Price and Opt-Out Option		5
Partnering		6
Execution of Signature Sheets and Debarment Certification		7
Submission of Design-Build Proposals		8
Alternate Technical Concepts and Confidential Questions		8
Value Analysis		12
Schedule of Estimated Completion Progress.....		13
Minority Business Enterprise and Women Business Enterprise.....		13
Contractor's License Requirements		24
Subsurface Information		24
Cooperation between Contractors		24
Bid Documentation.....		25
Twelve Month Guarantee		28
Outsourcing Outside the U.S.A.....		29
Clearing and Grubbing		29
SHPO Documentation for Borrow / Waste Sites		29
Burning Restrictions		30
Erosion & Sediment Control / Storm Water Certification.....		30
Procedure for Monitoring Borrow Pit Discharge.....		36
Culvert Pipe		37
Drainage Pipe.....		39
Pipe Installation and Pipe Culverts		40
Cement & Lime Stabilization of Sub-Grade Soils		45
Price Adjustments for Asphalt Binder.....		49
Price Adjustments - Asphalt Concrete Plant Mix		50
Field Office		50
Overhead Sign Supports		52
Overhead Sign Foundations.....		60
Safety Fence.....		68
Epoxy Pavement Marking Material		70
Dynamic Message Sign		74

GENERAL (GREEN SHEETS) 118

SCOPES OF WORK (GREEN SHEETS)

Roadway 133
 Pavement Management..... 140
 Structures 145
 Geotechnical Engineering..... 147
 Hydraulics..... 155
 Traffic Management 157
 Signing..... 175
 Pavement Markings 180
 GeoEnvironmental..... 182
 Utilities Coordination 184
 Right of Way..... 190
 Erosion and Sedimentation Control 193
 Lighting..... 199
 Environmental..... 202
 Public Information..... 203

PERMITS (WHITE SHEETS) 205

STANDARD SPECIAL PROVISIONS (YELLOW SHEETS)

Liability Insurance..... 299
 Plant and Pest Quarantines 300
 Contractor Claim Submittal Form..... 300
 Gifts from Vendors and Contractors 301
 Embankments..... 301
 Aggregate Subgrade 302
 Flowable Fill 302
 Bridge Approach Fills 303
 Fine Grading Subgrade, Shoulders and Ditches 305
 Aggregate Base Course 305
 Preparation of Sub-Grade and Base 305
 Aggregate for Soil-Cement Base 306
 Asphalt Pavements – Superpave..... 306
 Asphalt Paver – Fixed and Mobile String Line..... 323
 Asphalt Binder Content of Asphalt Plant Mixes..... 323
 Final Surface Testing – Asphalt Pavements 323
 Tying Proposed Concrete Pavement to Existing Concrete Pavement..... 327
 Concrete Pavements and Shoulders 327
 Subsurface Drainage..... 337
 Guardrail Anchor Units, Type M-350..... 338
 Guardrail Anchor Units, Type 350..... 339
 Impact Attenuator Units, Type 350..... 341

Fence.....	342
Preformed Scour Hole with Level Spread Apron	342
Street Signs and Markers and Route Markers.....	343
Steel U-Channel Posts	344
Shipping Signs	344
Galvanized High Strength Bolts, Nuts and Washers.....	344
Galvanizing	345
Aggregate Production.....	345
Concrete Brick and Block Production.....	345
Portland Cement Concrete (Alkali-Silica Reaction)	346
Glass Beads.....	346
Engineering Fabrics.....	347
Qualification of Welds and Procedures.....	348
Paint Sampling and Testing	349
Portable Concrete Barrier	349
Channelizing Devices (Drums).....	349
Temporary Shoring.....	351
Changeable Message Signs.....	358
Pavement Marking Lines	358
Excavation, Trenching, Pipe Laying & Backfilling for Utilities	360
On-the-Job Training	360
Availability of Funds – Termination of Contracts.....	364
NCDOT General Seed Specification for Seed Quality	365
Errata	368
Minimum Wages.....	372
Division One	373

PROPOSAL FORMS - ITEMIZED SHEET, ETC.

Itemized Proposal Sheet (WHITE SHEET)

Fuel Usage Factor Chart and Estimate of Quantities (WHITE SHEET)

Listing of MBE / WBE Subcontractors (YELLOW SHEET)

Execution of Bid, Noncollusion Affidavit, Debarment Certification and Gift Ban

Certification (YELLOW SHEETS)

Signature Sheet (YELLOW SHEET)

***** PROJECT SPECIAL PROVISIONS *******CONTRACT TIME AND LIQUIDATED DAMAGES**

(07-12-07)

DB1 G04A

The date of availability for this contract is **February 28, 2011** except that work in jurisdictional waters and wetlands shall not begin until a meeting between the DOT, Regulatory Agencies and the Design-Build Team is held.

The completion date for this contract is defined as the date proposed in the Technical Proposal by the proposer who is awarded the project. The completion date thus proposed shall not be later than **October 1, 2013**.

When observation periods are required by the special provisions, they are not a part of the work to be completed by the completion date and/or intermediate contract times. Should an observation period extend beyond the final completion date, the acceptable completion of the observation period shall be a part of the work covered by the performance and payment bonds.

The liquidated damages for this contract are **Twenty Thousand Dollars (\$20,000.00)** per calendar day. As an exception to this amount, where the contract has been determined to be substantially complete as defined by the Special Provision entitled "Substantial Completion" found elsewhere in this RFP, the liquidated damages will be reduced to **Five Thousand Dollars (\$5,000.00)** per calendar day.

Where the Design-Build Team who is awarded the contract has proposed a completion date for the contract as required above, but also has proposed an earlier date for substantial completion, then both of these proposed dates will become contract requirements.

Liquidated damages of **Twenty Thousand Dollars (\$20,000.00)** per calendar day will be applicable to the early date for substantial completion proposed by the bidder. Liquidated damages of **Five Thousand Dollars (\$5,000.00)** per calendar day will be applicable to the final completion date proposed by the bidder where the Design-Build Team has proposed an earlier date for substantial completion.

OTHER LIQUIDATED DAMAGES

(03-22-07) (Rev. 02-14-08)

DB1 G11

Refer to the Traffic Control Scope of Work for more information on the following time restrictions and liquidated damages:

Liquidated Damages for Intermediate Contract Time #1 for lane narrowing, lane closure, holiday and special event time restrictions for I-85, I-85 Business, and all **ramps / loops** is **\$5,000.00 per 30-minute period** or any portion thereof.

Liquidated Damages for Intermediate Contract Time #2 for lane narrowing, lane closure, holiday and special event time restrictions for **all other -Y- Lines and all Service Roads** are **\$500.00 per 30-minute period** or any portion thereof.

Liquidated Damages for Intermediate Contract Time #3 for road closure time restrictions for I-85, I-85 Business, and all ramps / loops are **\$2,500.00 per 15-minute period** or any portion thereof.

Liquidated Damages for Intermediate Contract Time #4 for road closure time restrictions for all other -Y- Lines and all Service Roads are **\$500.00 per 15-minute period** or any portion thereof

PROGRESS SCHEDULE

(07-29-09)

DB1 G12

Revise the 2006 *Standard Specifications for Roads and Structures* as follows:

Page 1-72, Article 108-2 Progress Schedule, delete in its entirety and replace with the following:

The Design-Build Team shall prepare and submit for review and approval a schedule of proposed working progress. This schedule shall be submitted on forms supplied by the Engineer or in a format that is approved by the Engineer. A detailed Critical Path Method (CPM) schedule shall not be submitted to replace the progress schedule details required below.

The Design-Build Team shall submit a Progress Schedule for review within thirty (30) calendar days of receiving Notice of Award. The Department will review the Progress Schedule within twenty-one (21) calendar days of receipt. The Design-Build Team shall make any necessary corrections and adjustments to the Progress Schedule as necessitated by the Department's review within seven (7) calendar days. The Department will review the revised Progress Schedule within seven (7) calendar days of receipt.

When the Engineer has extended the completion date the Design-Build Team shall submit a revised progress schedule to the Engineer for review and approval. If plan revisions are anticipated to change the sequence of operations in such a manner as will effect the progress but not the completion date, then the Design-Build Team may submit a revised progress schedule for review and approval but the completion date shall remain unchanged.

The proposed progress schedule shall contain the following items:

- (A) A time scale diagram with major work activities and milestone dates clearly labeled.
- (B) A cash curve corresponding to the milestones and work activities established above.
- (C) A written narrative that explains the sequence of work, the controlling operation(s), intermediate completion dates, milestones, project phasing, anticipated work schedule, and estimated resources. In addition, explain how permit requirements, submittal tracking, and coordination with subcontractors, utility companies and other entities will be performed.

Major work activities are defined as components comprising more than 5% of the total project cost or occupying more than 10% of total contract time and shall include, if applicable, the following:

- Clearing and grubbing
- Grading
- Drainage
- Soil stabilization
- Aggregate base course
- Pavement
- Culverts
- Bridges (including removal)
- Lighting
- Overhead signs
- Utility relocation and construction

Major Milestones are derived from the project construction phasing and shall include, if applicable, the following:

- Critical design submittal dates
- Critical permitting dates
- Completion of right of way acquisition
- Completion of Utility Conflicts
- Start of construction
- Intermediate completion dates or times
- Seasonal limitation /observation period s/ moratoriums
- Traffic shifts
- Beginning and end of each traffic control phase or work area
- Road openings
- Completion date

The Design-Build Team shall provide a written narrative each month detailing the work and percentage of work completed, anticipated sequence of upcoming work (2 month forecast), controlling operation(s), intermediate completion dates, and milestones. If any milestones are exceeded or will not be achieved, the Design-Build Team shall provide in the written narrative details of the delay; controlling operation affected, impacts to other operations, revisions to future intermediate completion dates and milestones, and remedial action necessary to get the project back to the original completion date.

PAYOUT SCHEDULE

(11-16-09)

DB1 G13

No later than 12:00 o'clock noon on the sixth day after the opening of the Price Proposal, the responsive proposer with the lowest adjusted price shall submit a proposed Anticipated Monthly Payout Schedule to the office of the State Contract Officer. The information shall be submitted in a sealed package with the outer wrapping clearly marked "Anticipated Monthly Payout Schedule" along with the Design-Build Team name and the contract number. The Anticipated Monthly Payout Schedule will be used by the Department to establish the monthly funding levels

for this project. The Anticipated Monthly Payout Schedule shall parallel, and agree with, the project schedule the Design-Build Team submits as a part of their Technical Proposal. The schedule shall include a monthly percentage breakdown (in terms of the total contract amount percentages) of the work anticipated to be completed. The schedule shall begin with the Date of Availability and end with the Actual Completion Date proposed by the Design-Build Team. If the Payout Schedule is not submitted as stated herein, the Technical and Price Proposals will be considered irregular by the Department, and the bid may be rejected.

Submit updates of the Anticipated Monthly Payout Schedule on March 15, June 15, September 15, and December 15 of each calendar year until project acceptance. Submit the all updates to the Resident Engineer with a copy to the State Construction Engineer at 1 South Wilmington St, 1543 Mail Service Center, Raleigh, NC 27699-1543.

MOBILIZATION

(10-31-05) (Rev 01-3-07)

DB1 G15A

Revise the 2006 *Standard Specifications for Roads and Structures* as follows:

Page 8-1, Subarticle 800-2, MEASUREMENT AND PAYMENT

Delete this subarticle in its entirety and replace with the following:

800-2 MEASUREMENT AND PAYMENT

5 percent of the “Total Amount of Bid for Entire Project” shall be considered the lump sum amount for Mobilization. Partial payments for Mobilization will be made beginning with the first partial pay estimate paid on the contract. Payment will be made at the rate of 50 percent of the lump sum amount calculated for Mobilization. The remaining 50 percent will be paid with the second partial payment.

SUBSTANTIAL COMPLETION

(3-22-07)

DB1 G16

When the special provisions provide for a reduction in the rate of liquidated damages for the contract time or an intermediate contract time after the work is substantially complete, the work will be considered substantially complete when the following requirements are satisfied:

1. Through traffic has been placed along the project or along the work required by an intermediate contract time and the work is complete to the extent specified below, and all lanes and shoulders are open such that traffic can move unimpeded at the posted speed. Intersecting roads and service roads are complete to the extent that they provide the safe and convenient use of the facility by the public.
2. The final layers of pavement for all lanes and shoulders along the project or along the work required by an intermediate contract time are complete.
3. All signs are complete and accepted except for the signs on intersecting roadways.
4. All guardrails, drainage devices, ditches, excavation and embankment are complete.

5. Remaining work along the project consists of permanent pavement markings, permanent pavement markers or incidental construction that is away from the paved portion of the roadway.

Upon apparent substantial completion of the entire project or the work required by an intermediate contract time, the Engineer will make an inspection of the work. If the inspection discloses the entire project or the work required by an intermediate contract time is substantially complete; the Engineer will notify the Design-Build Team in writing that the work is substantially complete. If the inspection discloses the entire project or the work required by an intermediate contract time is not substantially complete, the Engineer will notify the Design-Build Team in writing of the work that is not substantially complete. The entire project or the work required by an intermediate contract time will not be considered substantially complete until all of the recommendations made at the time of the inspection have been satisfactorily completed.

SUBMITTAL OF QUANTITIES, FUEL BASE INDEX PRICE AND OPT-OUT OPTION

(07-21-09)

DB1 G43

(A) Submittal of Quantities

Submit quantities on the *Fuel Usage Factor Chart and Estimate of Quantities* sheet, located in the back of this RFP, following the Itemized Proposal Sheet.

The Design-Build Team shall prepare an Estimate of Quantities that they anticipate incorporating into the completed project and upon which the Price Proposal was based. The quantity breakdown shall include all items of work that appear in the *Fuel Usage Factor Chart and Estimate of Quantities* sheet. Only those items of work which are specifically noted in the Fuel Usage Factor Chart will be subject to fuel price adjustments. The quantity estimate submitted in the Price Proposal shall be the final total quantity limit for which fuel price adjustments will be made for each item, regardless of supplemental agreements. The Department will review the Estimate of Quantities to ensure its reasonableness to the proposed design. Agreement of quantities will be a prerequisite prior to execution of the contract.

Submittal The submittal shall be signed and dated by an officer of the Design-Build Team. The information shall be copied and submitted in a separate sealed package with the outer wrapping clearly marked "Fuel Price Adjustment" and shall be delivered at the same time and location as the Technical and Price Proposal. The original shall be submitted in the Price Proposal.

Trade Secret Information submitted on the *Fuel Usage Factor Chart and Estimate of Quantities* sheet will be considered "Trade Secret" in accordance with the requirements of G.S. 66-152(3) until such time as the Price Proposal is opened.

(B) Base Index Price

The Design-Build Team's Estimate of Quantities will be used on the various partial payment estimates to determine fuel price adjustments. The Design-Build Team shall submit a payment request for quantities of work completed based on the work completed for that estimate period. The quantities requested for partial payment shall be reflective of the work actually accomplished for the specified period. The Design-Build Team shall certify that the quantities are reasonable for the specified period. The base index price for DIESEL #2 FUEL is \$ per gallon.

(C) Opt Out of Fuel Price Adjustment

If the Design-Build Team elects not to pursue reimbursement for Fuel Price Adjustments, a quantity of zero shall be entered for all quantities in the *Fuel Usage Factor Chart and Estimate of Quantities* and the declination box shall be checked. Failure to complete this form will mean that the Design-Build Team is declining the Fuel Price Adjustments for this project.

(D) Change Option

The proposer will not be permitted to change the option after the Price Proposal and the copy of the *Fuel Usage Factor Chart and Estimate of Quantities* sheet are submitted.

(E) Failure to submit

Failure to submit the completed *Fuel Usage Factor Chart and Estimate of Quantities* sheet separately and in the Price Proposal will result in the Technical and Price Proposal being considered irregular by the Department and the Technical and Price Proposal may be rejected.

PARTNERING

(07-29-09)

DB1 G49

As a part of its quality management program, the North Carolina Department of Transportation intends to encourage the formation of a cohesive relationship with the Design-Build Team and its principal subcontractors and suppliers. This relationship will be structured to draw on the strengths of each organization to identify and achieve reciprocal goals. The objectives are safe, effective, and efficient contract performance; and completion within budget, on schedule, and in accordance with the plans and specifications.

This relationship will be bilateral in makeup and participation will be totally voluntary. The cost associated with effectuating this relationship will be agreed to by both parties and shall be shared equally. Compensation for the Department's share of the partnering costs will be by Supplemental Agreement.

To implement this initiative prior to starting work in accordance with the requirements of Section 108 of the Standard Specifications and the Standard Special Provision for Division One (found elsewhere in this RFP), and prior to the preconstruction conference, the Design-Build Team's

management personnel and Division Construction Engineer will initiate a partnering development seminar/team building workshop. Project personnel working with the assistance of the Construction Unit will make arrangements to determine attendees at the workshop, agenda of the workshop, duration, and location. Persons required to be in attendance will be the NCDOT Resident Engineer, the NCDOT Division Construction Engineer, and key project personnel; the Design-Build Team's senior management personnel, the Design-Build Team's on-site project manager, and key project supervisory personnel for both the Design-Build Team and principal subcontractors and suppliers. The project design engineers, FHWA, and key local government personnel will also be invited to attend as necessary.

Follow-up workshops may be held periodically throughout the duration of the contract as agreed by the Design-Build Team and the North Carolina Department of Transportation. In the event that additional workshops are held, compensation for the Department's share of the follow-up partnering workshops will be by Supplemental Agreement.

The establishment of the partnering charter on a project will not change the legal relationship to the contract nor relieve either party from any of the terms of the contract.

EXECUTION OF SIGNATURE SHEETS AND DEBARMENT CERTIFICATION

(03-24-10)

DB1 G52

The Proposer's attention is directed to the various sheets in the Request for Proposals which are to be signed by the Proposer. A list of these sheets is shown below. The signature sheets are located behind the Itemized Proposal Sheet in this Request for Proposal. The NCDOT bid bond form is available on-line at:

http://www.ncdot.org/doh/preconstruct/altern/design_build/DesignbuildBidBond.pdf

or by contacting the Records and Documents office at 919-250-4124.

1. Applicable Signature Sheets: 1, 2, 3, 4, 5, or 6 (Bid)
2. Bid Bond dated the day of Technical and Price Proposal submission

The Proposer shall certify to the best of his knowledge all subcontractors, material suppliers and vendors utilized herein current status concerning suspension, debarment, voluntary exclusion, or determination of ineligibility by any federal agency, in accordance with the "Debarment Certification" located behind the *Execution of Bid Non-Collusion Affidavit, Debarment Certification and Gift Ban Certification* signature sheets in this RFP. Execution of the bid signature sheets in conjunction with any applicable statements concerning exceptions, when such statements have been made on the "Debarment Certification", constitutes the Proposer's certification of "status" under penalty of perjury under the laws of the United States.

SUBMISSION OF DESIGN-BUILD PROPOSAL

03-17-10

DB1 G55B

The Proposer's attention is directed that each Proposer's Design-Build Proposal shall comply with the following requirements in order for that Design-Build Proposal to be responsible and considered for award.

1. The Proposer shall be prequalified with the Department prior to submitting a Design-Build Proposal.
2. The Proposer shall deliver the Design-Build Proposal to the place indicated, and prior to the time indicated in this Request for Proposals.
3. The Design-Build Proposal documents shall be signed by an authorized employee of the Proposer.
4. The Design-Build Proposal shall be accompanied by Bid surety in the form of a Bid Bond or Bid Deposit, dated the day of Technical and Price Proposal submission.
5. If Minority and Women's Business Enterprise (MB/WB) goals are established for this contract, the Proposer shall complete the form Listing of MB/WB Subcontractors contained elsewhere in this RFP in accordance with the Project Special Provision entitled Minority Business Enterprise and Women Business Enterprise.
6. The Design-Build Proposal shall address all the requirements as specified in this Request for Proposals.

In addition to the above requirements, failure to comply with any of the requirements of Article 102-8 of the Standard Special Provisions, Division One (found elsewhere in this RFP) or Articles 102-10 or 102-11 of the 2006 *Standard Specifications for Roads and Structures* may result in a Design-Build Proposal being rejected.

ALTERNATIVE TECHNICAL CONCEPTS AND CONFIDENTIAL QUESTIONS

To accommodate innovation that may or may not be specifically allowed by the RFP, or other documents incorporated into the contract by reference, the Design-Build Team has the option of submitting Confidential Questions and Alternative Technical Concepts.

Definitions

A Confidential Question is defined as a private query to the Department containing information whose disclosure could alert others to certain details of doing business in a particular manner.

An Alternative Technical Concept is a private query to the Department that requests a variance to the requirements of the RFP, or other documents incorporated into the contract by reference, that is equal or better in quality or effect as determined by the Department in its sole discretion and that have been used elsewhere under comparable circumstances.

Confidential Questions

The Design-Build Team will be permitted to ask Confidential Questions of the Department, and neither the question nor the answer will be shared with other Design-Build Teams. The Department, in its sole discretion, will determine if a question is considered confidential.

Confidential Questions arising prior to issuance of the Final RFP will be allowed during the industry review of the draft RFP with the individual Design-Build Teams. The Department will answer the Confidential Question verbally at the industry review meeting, if possible, and/or through subtle changes in the Final RFP, which will clarify the scope by either allowing or disallowing the request. To the greatest extent possible, the revision will be made in such a manner as to not disclose the Confidential Question.

After the issuance of the Final RFP, Confidential Questions may be asked by requesting a meeting with the State Contract Officer. The request shall be in writing and provide sufficient detail to evaluate the magnitude of the request. Questions shall be of such magnitude as to warrant a special meeting. Minor questions will not be acknowledged or answered. After evaluation, the State Contract Officer will respond to the question in writing to the Design-Build Team and/or through subtle changes in the Final RFP as reflected in an addendum, which will clarify the scope by either allowing or disallowing the request. To the greatest extent possible, the revision will be made in such a manner as to not disclose the Confidential Question.

If the Design-Build Team includes work based on the Confidential Questions and answers, the work shall be discussed in the Technical Proposal.

Alternative Technical Concepts

The Design-Build Team may include an ATC in the Technical and Price Proposal only if the ATC has been received by the Department by no later than three weeks prior to the deadline for submitting Technical and Price Proposals and it has been approved by the Department (including conditionally approved ATCs, if all conditions are met).

The submittal deadline above applies only to initial ATC submittals. Resubmittal of an ATC that has been revised in response to the Department's requests for further information concerning a prior submittal shall be received by the Department no later than one week prior to the deadline for submitting Technical and Price Proposals.

Should the Department revise the RFP after a Formal ATC has been approved, the Design-Build Team shall be solely responsible for reviewing the RFP and determining if the ATC deviates from the revised requirements. If necessary, the Design-Build Team must submit a request for approval of all additional required variance(s) within five business days of the revised RFP distribution.

An ATC shall in no way take advantage of an error or omission in the RFP, or other documents incorporated into the contract by reference. If, at the sole discretion of the Department, an ATC is deemed to take an advantage of an error or omission in the RFP, or other documents incorporated into the contract by reference, the RFP will be revised without regard to confidentiality.

By approving an ATC, the Department acknowledges that the ATC may be included in the design and RFC plans; however, approval of any ATC in no way relieves the Design-Build Team of its obligation to satisfy (1) other contract requirements not specifically identified in the ATC submittal; (2) any obligation that may arise under applicable laws and regulations; and (3) any obligation mandated by the regulatory agencies as a permit condition.

ATC Submittals

Each ATC submittal shall include three individually bound hard copies and an electronic pdf file of the entire submittal and shall be submitted to the State Contract Officer at the address provided elsewhere in this RFP.

Formal ATCs

Each Formal ATC submittal shall include the following information:

- 1) Description. A detailed description and schematic drawings of the configuration of the ATC or other appropriate descriptive information (including, if appropriate, product details [i.e., specifications, construction tolerances, special provisions] and a traffic operational analysis, if appropriate);
- 2) Usage. Where and how the ATC would be used on the project;
- 3) Deviations. References to all requirements of the RFP, or other documents incorporated into the contract by reference, that are inconsistent with the proposed ATC, an explanation of the nature of the deviations from said requirements, and a request for approval of such variance(s);
- 4) Analysis. An analysis justifying use of the ATC and why the variance to the requirements of the RFP, or other documents incorporated into the contract by reference, should be allowed; Impacts. Discussion of potential impacts on vehicular traffic, environmental impacts identified, community impact, safety and life-cycle project impacts, and infrastructure costs (including impacts on the cost of repair and maintenance);
- 5) Impacts. Discussion of potential impacts on vehicular traffic, environmental impacts identified, community impact, safety and life-cycle project impacts, and infrastructure costs (including impacts on the cost of repair and maintenance);
- 6) History. A detailed description of other projects where the ATC has been used, the success of such usage, and names and telephone numbers of project owners that can confirm such statements;
- 7) Risks. A description of added risks to the Department and other entities associated with implementing the ATC; and
- 8) Costs. An estimate of the ATC implementation costs to the Department, the Design-Build Team, and other entities (right-of-way, utilities, mitigation, long term maintenance, etc.).

The Formal ATC, if approved, shall be included in the Price Proposal if the Design-Build Team elects to include it in their Technical Proposal.

Review of ATCs

A panel will be selected to review each ATC, which may or may not include members of the Technical Review Committee. The Design-Build Team shall make no direct contact with any member of the review panel, except as may be permitted by the State Contract Officer. Unapproved contact with any member of the review panel will result in a disqualification of that ATC.

The Department may request additional information regarding a proposed ATC at any time. The Department will return responses to, or request additional information from, the Design-Build Team within 15 business days of the original submittal of a Formal ATC. If additional information is requested, the Department will provide a response within 5 business days of receipt of all requested information.

The Department may conduct confidential one-on-one meeting(s) to discuss the Design-Build Team's ATC. Under no circumstances will the Department be responsible or liable to the Design-Build Team or any other party as a result of disclosing any ATC materials, whether the disclosure is deemed required by law, by an order of court, or occurs through inadvertence, mistake or negligence on the part of the Department or their respective officers, employees, contractors, or consultants.

In the event that the Department receives ATCs from more than one Design-Build Team that are deemed by the Department to be similar in nature, the Department reserves the right to modify the RFP without further regard for confidentiality.

The Department Response to Formal ATCs

The Department will review each Formal ATC and will respond to the Design-Build Team with one of the following determinations:

- 1) The ATC is approved;
- 2) The ATC is not approved;
- 3) The ATC is not approved in its present form, but may be approved upon satisfaction, in the Department's sole discretion, of certain identified conditions that shall be met or certain clarifications or modifications that shall be made (conditionally approved);
- 4) The submittal does not qualify as an ATC but may be included in the Proposal without an ATC (i.e., the concept complies with the baseline requirements of the RFP);
- 5) The submittal does not qualify as an ATC and may not be included in the Proposal; or
- 6) The ATC is deemed to take advantage of an error or omission in the RFP, or other documents incorporated into the contract by reference, in which case the ATC will not be considered, and the RFP will be revised to correct the error or omission.
- 7) More than one ATC has been received on the same topic and the Department has elected to exercise its right to revise the RFP. This response could also follow and supersede one of the other previously supplied responses above.

Formal ATC Inclusion in Technical Proposal

The Design-Build Team may incorporate one or more approved Formal ATCs as part of its Technical and Price Proposals. If the Department responded to an Formal ATC by stating that it would be approved if certain conditions were met, those conditions shall be stipulated and met in the Technical Proposal.

In addition to outlining each implemented Formal ATC, and providing assurances to meet all attached conditions, The Design-Build Team shall also include a copy of the Formal ATC approval letter from the State Contract Officer in each of the twelve Technical Proposals submitted. This letter will be included in the distribution of the Technical Proposals to the Technical Review Committee.

Approval of an Formal ATC in no way implies that the Formal ATC will receive a favorable review from the Technical Review Committee. The Technical Proposals will be evaluated in regards to the evaluation criteria found in this RFP, regardless of whether or not Formal ATCs are included.

The Price Proposal shall reflect all incorporated Formal ATCs. Except for incorporating approved Formal ATCs, the Technical Proposal may not otherwise contain exceptions to, or deviations from, the requirements of the RFP, or other documents incorporated into the contract by reference.

Preliminary ATCs

At the Design-Build Team's option, a Preliminary ATC submittal may be made that presents a concept and a brief narrative of the benefits of said concept. The purpose of allowing such a Preliminary ATC is to limit the Design-Build Team's expense in the pursuit of a Formal ATC that may be quickly denied by the Department.

The Department will review Preliminary ATCs as quickly as possible but the review of these Preliminary ATCs will not take precedence over the review of other outstanding Formal ATCs. The Department's response to a Preliminary ATC submittal will be either that the Preliminary ATC is denied, the Preliminary ATC would be considered as a Formal ATC if the Team so elects to pursue a Formal ATC submission, or an ATC is not required, with any associated comments. The Department in no way warrants that a favorable response to a Preliminary ATC submittal will translate into a favorable response to a Formal ATC submittal. Likewise, a favorable response to a Preliminary ATC submittal is not sufficient to include the ATC in a Technical Proposal.

VALUE ANALYSIS

(01-05-07)

DB1 G57

Value Engineering Construction Proposals (VECP), as identified in Article 104-12 of 2006 *Standard Specifications for Roads and Structures* will be accepted. Only proposals, which alter the requirements of the RFP issued by the Department, will be considered as Value Engineering Construction Proposals.

SCHEDULE OF ESTIMATED COMPLETION PROGRESS

(07-15-08)

DB1 G58

The Design-Build Team's attention is directed to the Standard Special Provision entitled "Availability of Funds - Termination of Contracts" included elsewhere in this RFP. The Department of Transportation's schedule of estimated completion progress for this project as required by that Standard Special Provision is as follows:

<u>Fiscal Year</u>	<u>Progress (Dollar Value)</u>
2011 (07/01/10 – 06/30/11)	5% of Total Amount Bid
2012 (07/01/11 – 06/30/12)	48% of Total Amount Bid
2013 (07/01/12 – 06/30/13)	35% of Total Amount Bid
2014 (07/01/13 – 06/30/14)	12% of Total Amount Bid

The Design-Build Team shall also furnish its own progress schedule in accordance with Project Special Provision entitled "Progress Schedule" (found elsewhere in this RFP). Any acceleration of the progress as shown by the Design-Build Team's progress schedule over the progress as shown above shall be subject to the approval of the Engineer.

MINORITY BUSINESS ENTERPRISE AND WOMEN BUSINESS ENTERPRISE

(10-21-10)

DB1 G67

Policy

It is the policy of the North Carolina Department of Transportation that Minority Business Enterprises (MBEs) and Women Business Enterprise (WBEs) as defined in *GS 136-28.4* shall have the equal opportunity to compete fairly for and to participate in the performance of contracts financed in whole or in part by State Funds.

Obligation

The Design-Build Team, subcontractor, and sub-recipient shall not discriminate on the basis of race, religion, color, creed, national origin, sex, handicapping condition or age in the performance of this contract. The Design-Build Team shall comply with applicable requirements of *GS 136-28.4* in the award and administration of state funded contracts. Failure by the Design-Build Team to comply with these requirements is a material breach of this contract, which may result in the termination of this contract or such other remedy, as the Department deems necessary.

Definitions

Commitment - The approved MBE / WBE participation submitted by the Design-Build Team during the procurement process.

Committed MBE / WBE - Any MBE / WBE listed on the MBE / WBE commitment list approved by the Department at the time of **Price Proposal** submission or any MBE / WBE utilized as a replacement for a MBE / WBE firm listed on the commitment list.

Department - North Carolina Department of Transportation

Minority Business Enterprise (MBE) – A firm certified as a Disadvantaged Minority-Owned Business Enterprise through the North Carolina Unified Certification Program.

Women Business Enterprise (WBE) – A firm certified as a Disadvantaged Women-Owned Business Enterprise through the North Carolina Unified Certification Program.

MBE / WBE – This term is used for convenience only. Minority Business Enterprise and Women Business Enterprise are not interchangeable terms and the goals for either or both are not interchangeable.

Goal - The MBE / WBE participation specified herein

Letter of Intent – Written documentation of the **Design-Build Team's** commitment to use a MBE / WBE subcontractor and confirmation from the MBE / WBE that it is participating in the contract.

Manufacturer - A firm that operates or maintains a factory or establishment that produces on the premises the materials or supplies obtained by the Design-Build Team.

Regular Dealer - A firm that owns, operates, or maintains a store, warehouse, or other establishment in which the materials or supplies required for the performance of the contract are bought, kept in stock, and regularly sold to the public in the usual course of business. A regular dealer engages in, as its principal business and in its own name, the purchase and sale or lease of the products in question. A regular dealer in such bulk items as steel, cement, gravel, stone, and petroleum products need not keep such products in stock, if it owns or operates distribution equipment. Brokers and packagers are not regarded as manufacturers or regular dealers within the meaning of this section.

SAF Subcontract Approval Form - Form required for approval to sublet the contract.

North Carolina Unified Certification Program - A program that provides comprehensive information to applicants for certification, such that an applicant is required to apply only once for a MBE/WBE certification that will be honored by all recipients of USDOT funds in the state and not limited to the Department of Transportation only. The Certification Program is in accordance with *49 CFR Part 26*.

Contract Goal

The following goals for participation by Minority Business Enterprises and Women Business Enterprises are established for this contract:

(A) Minority Business Enterprises 6 %

- (1) *If the goal is more than zero*, the Design-Build Team shall exercise all necessary and reasonable steps to ensure that Minority Business Enterprises participate in at least the percent of the contract as set forth above as the goal.
- (2) *If the goal is zero*, the Design-Build Team shall continue to recruit the MBEs and report the use of MBEs during the construction of the project. A good faith effort will not be required with a zero goal.

(B) Women Business Enterprises 7%

- (1) If the goal is more than zero, the Design-Build Team shall exercise all necessary and reasonable steps to ensure that Women Business Enterprises participate in at least the percent of the contract as set forth above as the goal.
- (2) *If the goal is zero*, the Design-Build Team shall continue to recruit the WBEs and report the use of WBEs during the construction of the project. A good faith effort will not be required with a zero goal.

These goals are to be met through utilization of highway construction contractors and / or right of way acquisition firms. Utilization of MBE / WBE firms performing design, other preconstruction services or Construction Engineering and Inspection are not included in this goal.

Contract Requirement

The approved MBE / WBE participation submitted by the Design-Build Team shall be the **Contract Requirement**.

Certified Transportation Firms Directory

Real-time information about firms doing business with the Department and firms that are certified through North Carolina's Unified Certification Program is available in the Directory of Transportation Firms. The Directory can be accessed by the link on the Department's homepage or by entering <https://apps.dot.state.nc.us/vendor/directory/> in the address bar of your web browser. Only firms identified as MBE/WBE certified in the Directory can be utilized to meet the contract goals.

The listing of an individual firm in the Department's directory shall not be construed as an endorsement of the firm's capability to perform certain work.

Listing of MBE / WBE Subcontractors in Contract

Only those MBE / WBE firms with current certification are acceptable for listing in the **Design-Build Team's** submittal of MBE / WBE participation. The Design-Build Team shall indicate the following required information:

- (1) *If the goal is more than zero, Proposers* at the time the Price Proposal is submitted, shall submit a listing of MBE / WBE participation on the appropriate form (or facsimile thereof) contained elsewhere in the RFP in order for the Price Proposal to be considered responsive. Proposers shall indicate the total dollar value of the MBE / WBE participation for the contract. If Proposer have no MBE / WBE participation, they shall indicate this on the form “Listing of MBE / WBE Subcontractors” by entering the word or number zero. This form shall be completed in its entirety. **Blank forms will not be deemed to represent zero participation.** Price Proposals submitted that do not have MBE / WBE participation indicated on the appropriate form will not be read publicly during the opening of Price Proposals. The Department will not consider these Price Proposals for award and the Price Proposal will be returned to the Proposer.
- (2) *If the goal is zero, Proposers* at the time the Price Proposal is submitted, shall enter the word “zero” or number “0” or if there is participation, add the value on the “Listing of MBE / WBE Subcontractors” (or facsimile thereof) contained elsewhere in the RFP.

Written Documentation – Letter of Intent

The Proposer shall submit written documentation of the Design-Build Team’s commitment to use MBE / WBE subcontractors whose participation it submits to meet a contract goal and written confirmation from each MBE / WBE, listed in the proposal, indicating their participation in the contract. This documentation shall be submitted on the Department’s form titled “Letter of Intent to Perform as a Subcontractor”. This letter of intent form is available at:

<http://www.ncdot.org/doh/preconstruct/ps/contracts/letterofintent.pdf>.

It shall be received in the office of the State Contractor Utilization Engineer no later than 12:00 noon of the sixth calendar day following opening of Price Proposals.

If the Proposer fails to submit the letter of intent from each committed MBE / WBE listed in the proposal indicating their participation in the contract, the MBE / WBE participation will not count toward meeting the goal.

Counting MBE / WBE Participation toward Meeting MBE / WBE Goal of Zero or More

- (A) If a firm is determined to be an eligible MBE / WBE firm, the total dollar value of the participation by the MBE / WBE will be counted toward the contract requirement. The total dollar value of participation by a certified MBE / WBE will be based upon the value of work actually performed by the MBE / WBE and the actual payments to MBE / WBE firms by the Design-Build Team.
- (B) When a MBE / WBE performs as a participant in a joint venture, the Design-Build Team may count toward its MBE / WBE goal a portion of the total value of participation with the MBE / WBE in the joint venture, that portion of the total dollar value being a distinct clearly defined portion of work that the MBE/WBE performs with its forces.

- (C) (1) The Design-Build Team may count toward its MBE / WBE goal only expenditures to MBEs / WBEs that perform a commercially useful function in the work of a contract. A MBE / WBE performs a commercially useful function when it is responsible for execution of the work of the contract and is carrying out its responsibilities by actually performing, managing, and supervising the work involved. To perform a commercially useful function, the MBE / WBE shall also be responsible with respect to materials and supplies used on the contract, for negotiating price, determining quality and quantity, ordering the material and installing (where applicable) and paying for the material itself. To determine whether a MBE / WBE is performing a commercially useful function, the Department will evaluate the amount of work subcontracted, industry practices, whether the amount the firm is to be paid under the contract is commensurate with the work it is actually performing and the MBE / WBE credit claimed for its performance of the work, and other relevant factors.
- (2) A MBE / WBE may enter into subcontracts. Work that a MBE / WBE subcontracts to another MBE / WBE firm may be counted toward the contract goal. Work that a MBE / WBE subcontracts to a non-MBE / non-WBE firm does not count toward the contract goal. If a MBE / WBE contractor or subcontractor subcontracts a significantly greater portion of the work of the contract than would be expected on the basis of standard industry practices, the MBE / WBE shall be presumed not to be performing a commercially useful function. The MBE / WBE may present evidence to rebut this presumption to the Department for commercially useful functions. The Department's decision on the rebuttal of this presumption will be final.
- (3) The following factors will be used to determine if a MBE / WBE trucking firm is performing a commercially useful function.
- (a) The MBE / WBE shall be responsible for the management and supervision of the entire trucking operation for which it is responsible on a particular contract, and there shall not be a contrived arrangement for the purpose of meeting MBE / WBE goals.
 - (b) The MBE / WBE shall itself own and operate at least one fully licensed, insured, and operational truck used on the contract.
 - (c) The MBE / WBE receives credit for the total value of the transportation services it provides on the contract using trucks it owns, insures, and operates using drivers it employs.
 - (d) The MBE / WBE may lease trucks from another MBE / WBE firm, including an owner-operator who is certified as a MBE / WBE. The MBE / WBE who leases trucks from another MBE / WBE receives credit for the total value of the transportation services the lessee MBE / WBE provides on the contract.

- (e) The MBE / WBE may also lease trucks from a non-MBE / non-WBE firm, including from an owner-operator. The MBE / WBE who leases trucks from a non-MBE / non-WBE is entitled to credit for the total value of transportation services provided by non-MBE / non-WBE lessees not to exceed the value of transportation services provided by MBE / WBE owned trucks on the contract. Additional participation by non-MBE / non-WBE lessees receives credit only for the fee or commission it receives as a result of the lease arrangement. The value of services performed under lease agreements between the MBE / WBE and Design-Build Team will not count towards the contract requirement.
 - (f) For purposes of this paragraph, a lease shall indicate that the MBE / WBE has exclusive use of and control over the truck. This does not preclude the leased truck from working for others during the term of the lease with the consent of the MBE / WBE, so long as the lease gives the MBE / WBE absolute priority for use of the leased truck. Leased trucks shall display the name and identification number of the MBE / WBE.
- (D) A Design-Build Team may count toward its MBE / WBE goals 60 percent of its expenditures for materials and supplies required to complete the contract and obtained from MBE / WBE regular dealer and 100 percent of such expenditures to a MBE / WBE manufacturer.
- (E) A Design-Build Team may count toward its MBE / WBE goals the following expenditures to MBE / WBE firms that are not manufacturers or regular dealers:
- (1) The fees or commissions charged by a MBE / WBE firm for providing a bona fide service, such as professional, technical, consultant, or managerial services, or for providing bonds or insurance specifically required for the performance of a DOT-assisted contract, provided the fees or commissions are determined to be reasonable and not excessive as compared with fees and commissions customarily allowed for similar services.
 - (2) The fees or commissions charged for assistance in the procurement of the materials and supplies, or for transportation charges for the delivery of materials or supplies required on a job site (but not the cost of the materials and supplies themselves), provided the fees are not from a manufacturer or regular dealer and provided the fees are determined to be reasonable and not excessive as compared with fees customarily allowed for similar services.

Good Faith Effort for Projects with Goals more than Zero

If the MBE / WBE participation submitted in the **Price Proposal** by the **Proposer with the apparent adjusted low price** does not meet or exceed the MBE / WBE contract goals, **this Proposer** shall submit to the Department documentation of its good faith efforts made to reach each contract goal. One complete set and 9 copies of this information shall be received in the office of the State Contractor Utilization Engineer no later than 12:00 noon of the sixth calendar

day following opening of **Price Proposals**. Where the information submitted includes repetitious solicitation letters it will be acceptable to submit a representative letter along with a distribution list of the firms that were solicited. Documentation of MBE / WBE quotations shall be a part of the good faith effort submittal as necessary to demonstrate compliance with the factors listed below which the Department considers in judging good faith efforts. This documentation may include written subcontractor quotations, telephone log notations of verbal quotations, or other types of quotation documentation.

The following factors will be used to determine if the **Proposer** has made adequate good faith effort:

- (A) Whether the **Proposer** attended any pre-bid meetings that were scheduled by the Department to inform MBEs / WBEs of subcontracting opportunities.
- (B) Whether the **Proposer** provided solicitations through all reasonable and available means (e.g. advertising in newspapers owned and targeted to the MBEs / WBEs at least 10 calendar days prior to **Price Proposal** opening. Whether the **Proposer** provided written notice to all MBEs / WBEs listed in the NCDOT Directory of Transportation Firms, within the Divisions and surrounding Divisions where the project is located, that specialize in the areas of work (as noted in the MBE / WBE Directory) that the **Proposer** will be subletting.
- (C) Whether the **Proposer** followed up initial solicitations of interests by contacting MBEs / WBEs to determine with certainty whether they were interested. If a reasonable amount of MBEs / WBEs within the targeted Divisions do not provide an intent to quote or no MBEs / WBEs specialize in the subcontracted areas, the **Proposer** shall notify MBEs / WBEs outside of the targeted Divisions that specialize in the subcontracted areas, and call the Director of Business and Opportunity Workforce Development to give notification of the **Proposer's** inability to get MBE / WBE quotes.
- (D) Whether the **Proposer** selected portions of the work to be performed by MBEs / WBEs in order to increase the likelihood of meeting the contract goals. This includes, where appropriate, breaking out contract work items into economically feasible units to facilitate MBE / WBE participation, even when the **Proposer** might otherwise perform these work items with its own forces.
- (E) Whether the **Proposer** provided interested MBEs / WBEs with adequate and timely information about the plans, specifications and requirements of the contract.
- (F) Whether the **Proposer** negotiated in good faith with interested MBEs / WBEs without rejecting them as unqualified without sound reasons based on a thorough investigation of their capabilities. Any rejection should be noted in writing with a description as to why an agreement could not be reached.
- (G) Whether quotations were received from interested MBE / WBE firms but rejected as unacceptable without sound reasons why the quotations were considered unacceptable.

- (H) Whether the **Proposer** specifically negotiated with subcontractors to assume part of the responsibility to meet the contract MBE / WBE goals when the work to be sublet includes potential for MBE / WBE participation.
- (I) Whether the **Proposer** made any efforts and / or offered assistance to interested MBEs / WBEs in obtaining the necessary equipment, supplies, materials, insurance, and / or bonding to satisfy the work requirements in the **RFP**.
- (J) Any other evidence that the **Proposer** submits which show that the **Proposer** has made reasonable good faith efforts to meet the contract goals.

If a **Proposer** is the **Proposer with the apparent adjusted low price or apparent lowest responsive bidder** on more than one project within the same letting located in the same geographic area of the state, as a part of the good faith effort the Department will consider allowing the **Proposer** to combine the MBE participation as long as the overall MBE goal value of the combined projects is achieved.

If a **Proposer** is the **Proposer with the apparent adjusted low price or apparent lowest responsive bidder** on more than one project within the same letting located in the same geographic area of the state, as a part of the good faith effort the Department will consider allowing the **Proposer** to combine the WBE participation as long as the overall WBE goal value of the combined projects is achieved.

If the Department does not award the contract to the **Proposer with the apparent adjusted low price**, the Department reserves the right to award the contract to the **Proposer with the next apparent low price that can satisfy the Department that the contract goal can be met or that adequate good faith efforts have been made to meet the goal.**

Banking MBE / WBE Credit

If the **Price Proposal** of the **Proposer with the apparent adjusted low price** exceeds \$500,000 and if the MBE / WBE participation submitted exceeds the algebraic sum of the MBE / WBE goals by \$1000 or more, the excess will be placed on deposit by the Department for future use by the **Proposer**. Separate accounts will be maintained for MBE and WBE participation and these may accumulate for a period not to exceed 24 months.

When the **Proposer with the apparent adjusted low price** fails to submit sufficient participation by MBE firms to meet the contract goal, as part of the good faith effort, the Department will consider allowing the **Proposer** to withdraw funds to meet the MBE goal so long as there are adequate funds available from the **Proposer's** MBE bank account.

When the **Proposer with the apparent adjusted low price** fails to submit sufficient participation by WBE firms to meet the contract goal, as part of the good faith effort, the Department will consider allowing the **Proposer** to withdraw funds to meet the WBE goal so long as there are adequate funds available from the **Proposer's** WBE bank account.

MBE / WBE Replacement

The Design-Build Team shall not terminate a committed MBE / WBE subcontractor for convenience or perform the work with its own forces or those of an affiliate. If the Design-Build Team fails to demonstrate reasonable efforts to replace a committed MBE / WBE firm that does not perform as intended with another committed MBE / WBE firm or completes the work with its own forces without the Engineer's approval, the Design-Build Team may be disqualified from further bidding for a period of up to 6 months.

The Design-Build Team shall comply with the following for replacement of committed MBE / WBE firms.

(A) Performance Related Replacement

When a MBE / WBE is terminated or fails to complete its work on the contract for any reason, the Design-Build Team shall take all necessary, reasonable steps to replace the MBE / WBE subcontractor with another MBE / WBE subcontractor to perform at least the same amount of work as the MBE / WBE that was terminated. The Design-Build Team is encouraged to first attempt to find another MBE / WBE firm to do the same work as the MBE / WBE that was being terminated.

To demonstrate necessary, reasonable good faith efforts, the Design-Build Team shall document the steps they have taken to replace any MBE / WBE subcontractor who is unable to perform successfully with another MBE / WBE subcontractor. Such documentation shall include but not be limited to the following:

- (1) Copies of written notification to MBEs / WBEs that their interest is solicited in subcontracting the work defaulted by the previous MBE / WBE subcontractor or in subcontracting other items of work in the contract.
- (2) Efforts to negotiate with MBEs / WBEs for specific subbids including, at a minimum:
 - (a) The names, addresses, and telephone numbers of MBEs / WBEs who were contacted.
 - (b) A description of the information provided to MBEs / WBEs regarding the plans and specifications for portions of the work to be performed.
- (3) For each MBE / WBE contacted but rejected as unqualified, the reasons for the Design-Build Team's conclusion.
- (4) Efforts made to assist the MBEs / WBEs contacted, if needed, in obtaining bonding or insurance required by the Design-Build Team.

(B) Decertification Replacement

- (1) When a committed MBE / WBE is decertified by the Department after a Request for Subcontract has been received by the Department, the Department will not require the Design-Build Team to solicit replacement MBE / WBE participation equal to the remaining work to be performed by the decertified firm. The participation equal to the remaining work performed by the decertified firm will count toward the contract requirement.
- (2) When a committed MBE / WBE is decertified prior to the Department receiving a Request for Subcontract for the named MBE / WBE firm, the Design-Build Team shall take all necessary and reasonable steps to replace the MBE / WBE subcontractor with another MBE / WBE subcontractor to perform at least the same amount of work to meet the contract goal or demonstrate that it has made a good faith effort to do so.

Changes in the Work

When the Engineer makes changes that result in the reduction or elimination of work to be performed by a committed MBE / WBE, the Design-Build Team will not be required to seek additional participation. When the Engineer makes changes that result in additional work to be performed by a MBE / WBE based upon the Design-Build Team's commitment, the MBE / WBE shall participate in additional work to the same extent as the MBE / WBE participated in the original contract work.

When the Engineer makes changes that result in extra work, which has more than a minimal impact on the contract amount, the Design-Build Team shall seek additional participation by MBEs / WBEs unless otherwise approved by the Engineer.

When the Engineer makes changes that result in an alteration of plans or details of construction and a portion or all of work had been expected to be performed by a committed MBE / WBE, the Design-Build Team shall seek participation by MBEs / WBEs unless otherwise approved by the Engineer.

When the Design-Build Team requests changes in the work that result in the reduction or elimination of work that the Design-Build Team committed to be performed by a MBE / WBE, the Design-Build Team shall seek additional participation by MBEs / WBEs equal to the reduced MBE / WBE participation caused by the changes.

Reports

A Subcontract Approval Form shall be submitted for all work which is to be performed by a MBE/WBE subcontractor, both committed and non-committed subcontractors. The Department reserves the right to require copies of actual subcontract agreements involving MBE/WBE subcontractors.

Within 30 calendar days of entering an agreement with a MBE/WBE for materials, supplies or services, not otherwise documented by a Request for Subcontract as specified above, the Contractor shall furnish the Engineer a copy of the agreement. The documentation should also indicate the percentage (60% or 100%) of expenditures claimed for MBE/WBE credit.

All certifications will be considered a part of the project records, and consequently will be subject to penalties under State Law associated with falsifications of records related to projects.

Reporting MBE / WBE Participation

- (A) The Design-Build Team shall provide the Engineer with an accounting of payments made to MBE / WBE firms, including material suppliers, contractors at all levels (prime, subcontractor, or second tier subcontractor). This accounting shall be furnished to the Engineer for any given month by the end of the following month. Failure to submit this information accordingly may result in the following action:
- (1) Withholding of money due in the next partial pay estimate; or
 - (2) Removal of any affiliated company of the Design-Build Team from the Department's appropriate prequalified list or the removal of other entities from the approved subcontractors list.
- (B) The Design-Build Team shall report the accounting of payments on the Department's MBE / WBE Subcontractor Payment Information Form MBE / WBE-IS, which is available at:
<http://www.ncdot.org/doh/forms/files/MBE/WBE-IS.xls>
- (C) Design-Build Teams reporting transportation services provided by non-MBE / non-WBE lessees shall evaluate the value of services provided during the month of the reporting period only.

Prior to payment of the final estimate, the Design-Build Team shall furnish an accounting of total payment to each MBE / WBE. A responsible fiscal officer of the payee contractor, subcontractor, or second tier subcontractor who can attest to the date and amounts of the payments shall certify that the accounting is correct.

While each contractor (prime, subcontractor, 2nd tier subcontractor) is responsible for accurate accounting of payments to MBEs / WBEs, it shall be the prime contractor's responsibility to report all monthly and final payment information in the correct reporting manner.

Failure on the part of the **Design-Build Team** to submit the required information in the time frame specified may result in the disqualification of that **Design-Build Team** and any affiliate companies from further bidding until the required information is submitted.

Failure on the part of any subcontractor to submit the required information in the time frame specified may result in the disqualification of that contractor and any affiliate companies from working on any DOT project until the required information is submitted.

Failure to Meet Contract Requirements

Failure to meet contract requirements in accordance with Article 102-16(J) of the *Standard Specifications* may be cause to disqualify the Design-Build Team.

CONTRACTOR'S LICENSE REQUIREMENTS

(07-01-95)

DB1 G88

If the Design-Build Team does not hold the proper license to perform any plumbing, heating, air conditioning, or electrical work in this contract, he will be required to sublet such work to a contractor properly licensed in accordance with *Article 2 of Chapter 87 of the General Statutes* (licensing of heating, plumbing, and air conditioning contractors) and *Article 4 of Chapter 87 of the General Statutes* (licensing of electrical contractors).

SUBSURFACE INFORMATION

(03-22-07)

DB1 G119

Available subsurface information will be provided on this project. The Design-Build Team shall be responsible for additional investigations and for verifying the accuracy of the subsurface information supplied by the Department.

COOPERATION BETWEEN CONTRACTORS

(07-01-95) (Rev 05-27-10)

DB1 G133

The Design-Build Team's attention is directed to Article 105-7 of the Standard Special Provision, Division One contained elsewhere in this RFP.

TIP Project I-2304AC is the widening of I-85 from North of SR 2120 (Long Ferry Road) to North of NC 150 in Rowan and Davidson Counties, and will be constructed concurrently with this contract.

The Design-Build Team on this project shall cooperate with the Design-Build Team working within or adjacent to the limits of this project to the extent that the work can be carried out to the best advantage of all concerned.

The Design-Build Team shall coordinate with the I-2304AC contractor in the planning, scheduling, design and construction of the elements that affect both entities. Close coordination with the I-2304AC Design-Build Team to successfully plan, design and construct the two projects concurrently is essential. The Department will not honor any requests for additional contract time or compensation for failure to coordinate construction schedules with the I-2304AC Design-Build Team. Specific areas of coordination include but are not limited to:

- Ensure accurate hydrological, horizontal and vertical ties that adhere to the design criteria.
- Maintain safe traffic operation and pavement markings at all times during construction of these two projects.

Meetings shall be scheduled and attended by authorized representatives of this Design-Build Team and include personnel from the I-2304AC Design-Build Team and any other pertinent

Contractors, and representatives from NCDOT. At a minimum, there shall be meetings during the construction process and a post-construction meeting shall be held to reach concurrence that all the construction components have been installed properly.

BID DOCUMENTATION:

(1-1-02) (Rev. 10-19-10)

DB1 G142

General

The successful Design-Build Team shall submit the original, unaltered bid documentation or a certified copy of the original, unaltered bid documentation used to prepare the Price Proposal for this contract to the Department within 10 days after receipt of notice of award of contract. Such documentation shall be placed in escrow with a banking institution or other bonded document storage facility selected by the Department.

The Department will not execute the contract until the original, unaltered bid documentation or a certified copy of the original, unaltered bid documentation has been received by the Department.

Terms

Bid Documentation – Bid Documentation shall mean all written information, working papers, computer printouts, electronic media, charts, and all other data compilations which contain or reflect information, data, and calculations used by the Proposer in the preparation of the Price Proposal. The term *bid documentation* includes, but is not limited to, Design-Build Team equipment rates, Design-Build Team overhead rates, labor rates, efficiency or productivity factors, arithmetical calculations, and quotations from subcontractors and material suppliers to the extent that such rates and quotations were used by the Proposer in formulating and determining the Price Proposal. The term *bid documentation* also includes any manuals, which are standard to the industry used by the Proposer in determining the Price Proposal. Such manuals may be included in the bid documentation by reference. Such reference shall include the name and date of the publication and the publisher. *Bid Documentation* does not include bid documents provided by the Department for use by the Proposer in bidding on this project.

Design-Build Team's Representative – Officer of the Prime Contractor's company; if not an officer, the Contractor shall supply a letter signed and notarized by an officer of the Prime Contractor's company, granting permission for the representative to sign the escrow agreement on behalf of the Prime Contractor.

Escrow Agent – Officer of the select banking institution or other bonded document storage facility authorized to receive and release bid documentation.

Escrow Agreement Information

A copy of the Escrow Agreement will be mailed to the Proposer with the notice of award for informational purposes. The Proposer and Department will sign the actual Escrow Agreement at the time the bid documentation is delivered to the escrow agent.

Failure to Provide Bid Documentation

The Proposer's failure to provide the original, unaltered bid documentation or a certified copy of the original, unaltered bid documentation within 10 days after the notice of award is received by him may be just cause for rescinding the award of the contract and may result in the removal of the Proposer from the Department's list of qualified bidders for a period of up to 180 days. Award may then be made to the Proposer with the next lowest adjusted price or the work may be readvertised and constructed under the contract or otherwise, as the Department may decide.

Submittal of Bid Documentation

- (A) Delivery - A representative of the Proposer shall deliver the original, unaltered bid documentation or a certified copy of the original, unaltered bid documentation to the Department, in a container suitable for sealing, within 10 days after the notice of award is received by him. Bid documentation will be considered a certified copy if the Proposer includes a letter to the Department from a chief officer of the company stating that the enclosed documentation is an *EXACT* copy of the original documentation. The letter shall be signed by a chief officer of the company, have the person's name and title typed below the signature, and the signature shall be notarized at the bottom of the letter.
- (B) Packaging – The container shall be no larger than 15.5 inches in length by 12 inches wide by 11 inches high and shall be water resistant. The container shall be clearly marked on the face and the back of the container with the following information: Bid Documentation, Proposer's Name, Proposer's Address, Date of Escrow Submittal, Contract Number, TIP Number if applicable, and County.

Affidavit

In addition to the bid documentation, an affidavit signed under oath by an individual authorized by the Proposer to execute the bid shall be included. The affidavit shall list each bid document with sufficient specificity so a comparison may be made between the list and the bid documentation to ensure that all of the bid documentation listed in the affidavit has been enclosed. The affidavit shall attest that the affiant has personally examined the bid documentation, that the affidavit lists all of the documents used by the Proposer to determine the Price Proposal for this project, and that all such bid documentation has been included.

Verification

Upon delivery of the bid documentation, the Department's Contract Officer and the Proposer's representative will verify the accuracy and completeness of the bid documentation compared to the affidavit. Should a discrepancy exist, the Proposer's representative shall immediately furnish the Department's Contract Officer with any other needed bid documentation. The Department's Contract Officer upon determining that the bid documentation is complete will, in the presence of the Proposer's representative, immediately place the complete bid documentation and affidavit in the container and seal it. Both parties will deliver the sealed container to the escrow agent for placement in a safety deposit box, vault, or other secure accommodation.

Confidentiality of Bid Documentation

The bid documentation and affidavit in escrow are, and will remain, the property of the Proposer. The Department has no interest in, or right to, the bid documentation and affidavit other than to verify the contents and legibility of the bid documentation unless the Design-Build Team gives written notice of intent to file a claim, files a written claim, files a written and verified claim, or initiates litigation against the Department. In the event of such written notice of intent to file a claim, filing of a written claim, filing a written and verified claim, or initiation of litigation against the Department, or receipt of a letter from the Design-Build Team authorizing release, the bid documentation and affidavit may become the property of the Department for use in considering any claim or in litigation as the Department may deem appropriate.

Any portion or portions of the bid documentation designated by the Proposer as a *trade secret* at the time the bid documentation is delivered to the Department's Contract Officer shall be protected from disclosure as provided by *G.S. 132-1.2*.

Duration and Use

The bid documentation and affidavit shall remain in escrow until 60 calendar days from the time the Contractor receives the final estimate; or until such time as the Design-Build Team:

- (A) Gives written notice of intent to file a claim,
- (B) Files a written claim,
- (C) Files a written and verified claim,
- (D) Initiates litigation against the Department related to the contract; or
- (E) Authorizes in writing its release.

Upon the giving of written notice of intent to file a claim, filing a written claim, filing a written and verified claim, or the initiation of litigation by the Design-Build Team against the Department, or receipt of a letter from the Design-Build Team authorizing release, the Department may obtain the release and custody of the bid documentation.

The Proposer certifies and agrees that the sealed container placed in escrow contains all of the bid documentation used to determine the Price Proposal and that no other bid documentation shall be relevant or material in litigation over claims brought by the Design-Build Team arising out of this contract.

Release of Bid Documentation to the Contractor

If the bid documentation remains in escrow 60 calendar days after the time the Design-Build Team receives the final estimate and the Design-Build Team has not filed a written claim, filed a written and verified claim, or has not initiated litigation against the Department related to the contract, the Department shall instruct the escrow agent to release the sealed container to the Prime Contractor.

The Contractor will be notified by certified letter from the escrow agent that the bid documentation will be released to the Contractor. The Contractor or his representative shall

retrieve the bid documentation from the escrow agent within 30 days of the receipt of the certified letter. If the Contractor does not receive the documents within 30 days of the receipt of the certified letter, the Department will contact the Contractor to determine final dispersion of the bid documentation.

Payment

The cost of the escrow will be borne by the Department. There will be no separate payment for all costs of compilation of the data, container, or verification of the bid documentation. Payment at the various contract unit or lump sum prices in the contract will be full compensation for all such costs.

TWELVE MONTH GUARANTEE

(07-15-03)

DB1 G145

- (A) The Design-Build Team shall guarantee materials and workmanship against latent and patent defects arising from faulty materials, faulty workmanship or negligence for a period of twelve months following the date of final acceptance of the work for maintenance and shall replace such defective materials and workmanship without cost to the Department. The Design-Build Team will not be responsible for damage due to faulty design, normal wear and tear, for negligence on the part of the Department, and/or for use in excess of the design.
- (B) Where items of equipment or material carry a manufacturer's guarantee for any period in excess of twelve months, then the manufacturer's guarantee shall apply for that particular piece of equipment or material. The Department's first remedy shall be through the manufacturer although the Design-Build Team shall be responsible for invoking the warranted repair work with the manufacturer. The Design-Build Team's responsibility shall be limited to the term of the manufacturer's guarantee. NCDOT would be afforded the same warranty as provided by the Manufacturer.

This guarantee provision shall be invoked only for major components of work in which the Design-Build Team would be wholly responsible for under the terms of the contract. Examples would include pavement structures, bridge components and sign structures. This provision will not be used as a mechanism to force the Design-Build Team to return to the project to make repairs or perform additional work that the Department would normally compensate the Design-Build Team for. In addition, routine maintenance activities (i.e. mowing grass, debris removal, ruts in earth shoulders,) are not parts of this guarantee.

Appropriate provisions of the payment and/or performance bonds shall cover this guarantee for the project. In addition, failure on the part of the responsible entity(ies) of the Design-Build Team to perform guarantee work within the terms of this provision shall be just cause to remove the responsible entity(ies) from the Department's corresponding prequalified list. The Design-Build Team will be removed for a minimum of 6 months and will be reinstated only after all work has been corrected and the Design-Build Team requests reinstatement in writing.

To ensure uniform application statewide the Division Engineer will forward details regarding the circumstances surrounding any proposed guarantee repairs to the Chief Engineer for review and approval prior to the work being performed.

OUTSOURCING OUTSIDE THE USA

(05-16-06)

DB1 G150

All work on consultant contracts, services contracts, and construction contracts shall be performed in the United States of America. No work shall be outsourced outside of the United States of America.

Outsourcing for the purpose of this provision is defined as the practice of subcontracting labor, work, services, staffing, or personnel to entities located outside of the United States.

The North Carolina Secretary of Transportation shall approve exceptions to this provision in writing.

CLEARING AND GRUBBING

(01-22-08)

DB2 R01

With the exception of areas with Permanent Utility Easements, perform clearing on this project to the limits established by Method "III" shown on Standard No. 200.03 of the *2006 NCDOT Roadway Standard Drawings*. In areas with Permanent Utility Easements, clearing shall extend to the Right of Way limits.

Revise the 2006 *Standard Specifications for Roads and Structures* as follows:

Page 2-2, Article 200-3, Clearing, add the following as the 6th paragraph:

At bridge sites, clear the entire width of the right of way beginning at a station 3 feet back of the beginning extremity of the structure and ending at a station 3 feet beyond the ending extremity of the structure.

SHPO DOCUMENTATION FOR BORROW/WASTE SITES

(12-18-07)

DB8 R02

Revise the 2006 *Standard Specifications for Roads and Structures* as follows:

Division 2 Earthwork

Page 2-16, Subarticle 230-1(D), add the words: *The Contractor specifically waives* as the first words of the sentence.

Page 2-17, Subarticle 230-4(B) Contractor Furnished Sources, first paragraph, first sentence replace with the following:

Prior to the approval of any borrow sources developed for use on any project, obtain certification from the State Historic Preservation Officer of the State Department of Cultural

Resources certifying that the removal of the borrow material from the borrow sources(s) will have no effect on any known district, site building, structure, or object, architectural and / or archaeological that is included or eligible for inclusion in the National Register of Historic Places.

Division 8 Incidentals

Page 8-9, Article 802-2 General Requirements, add the following as the 1st paragraph:

Prior to the removal of any waste from any project, obtain certification from the State Historic Preservation Officer of the State Department of Cultural Resources certifying that the deposition of the waste material to the proposed waste area will have no effect on any known district, site building, structure, or object, architectural and / or archaeological that is included or eligible for inclusion in the National Register of Historic Places. Furnish a copy of this certification to the Engineer prior to performing any work in the proposed waste site.

Page 8-10, Article 802-2, General Requirements, 4th paragraph, add the following as the 2nd sentence:

The Department's borrow and waste site reclamation procedures for contracted projects is available on the NCDOT website and shall be used for all borrow and waste sites on this project.

BURNING RESTRICTIONS

(07-01-95)

DB2 R05

Open burning is not permitted on any portion of the right of way limits established for this project. The Design-Build Team shall not burn the clearing, grubbing or demolition debris designated for disposal and generated from the project at locations within the project limits, off the project limits or at any waste or borrow sites in Davidson County. The Design-Build Team shall dispose of the clearing, grubbing and demolition debris by means other than burning and in accordance with state and local rules and regulations.

EROSION & SEDIMENT CONTROL / STORMWATER CERTIFICATION

(10-20-10)

DB1 G180

General

Schedule and conduct construction activities in a manner that will minimize soil erosion and the resulting sedimentation and turbidity of surface waters. Comply with the requirements herein regardless of whether or not a National Pollutant Discharge Elimination System (NPDES) permit for the work is required.

Establish a chain of responsibility for operations and subcontractors' operations to ensure that the *Erosion and Sediment Control / Stormwater Pollution Prevention Plan* is implemented and maintained over the life of the contract.

- (A) *Certified Supervisor* – Provide a certified Erosion and Sediment Control / Stormwater (E&SC/SW) Supervisor to manage the Design-Build Team and subcontractor(s) operations, ensure compliance with Federal, State and Local ordinances and regulations, and to manage the Quality Control Program.
- (B) *Certified Foreman* – Provide a certified, trained foreman for each construction operation that increases the potential for soil erosion or the possible sedimentation and turbidity of surface waters.
- (C) *Certified Installer* – Provide a certified installer to install or direct the installation for erosion and sediment control / stormwater practices.
- (D) *Certified Designer* – Provide a certified designer for the design of the erosion and sediment control / stormwater component of reclamation plans and, if applicable, for the design of the project erosion and sediment control / stormwater plan.

Roles and Responsibilities

- (A) *Certified Erosion and Sediment Control / Stormwater Supervisor* - The Certified Supervisor shall be Level II and responsible for ensuring erosion and sediment control / stormwater plan is adequately implemented and maintained on the project and for conducting the quality control program. The Certified Supervisor shall be on the project within 24 hours notice from initial exposure of an erodible surface to the project's final acceptance. Perform the following duties:
 - (1)
 - (a) Manage Operations - Coordinate and schedule the work of subcontractors so that erosion and sediment control / stormwater measures are fully executed for each operation and in a timely manner over the duration of the contract.
 - (b) Prepare the required National Pollutant Discharge Elimination System (NPDES) Inspection Record and submit to the Engineer.
 - (c) Attend all weekly or monthly construction meetings to discuss the findings of the NPDES inspection and other related issues.
 - (d) Implement the erosion and sediment control / stormwater site plans requested.
 - (e) Provide any needed erosion and sediment control / stormwater practices for the Design-Build Team's temporary work not shown on the plans, such as, but not limited to work platforms, temporary construction, pumping operations, plant and storage yards, and cofferdams.
 - (f) Acquire applicable permits and comply with requirements for borrow pits, dewatering, and any temporary work conducted by the Design-Build Team in jurisdictional areas.
 - (g) Conduct all erosion and sediment control / stormwater work in a timely and workmanlike manner.
 - (h) Fully perform and install erosion and sediment control / stormwater work prior to suspension of the work.

- (i) Coordinate with Department, Federal, State and Local Regulatory agencies on resolution of erosion and sediment control / stormwater issues due to the Design-Build Team's operations.
 - (j) Ensure that proper cleanup occurs from vehicle tracking on paved surfaces and / or any location where sediment leaves the Right-of-Way.
 - (k) Have available a set of erosion and sediment control/stormwater plans that are initialed and include the installation date of Best Management Practices. These practices shall include temporary and permanent groundcover and be properly updated to reflect necessary plan and field changes for use and review by Department personnel as well as regulatory agencies.
- (2) Requirements set forth under the NPDES Permit – The Department's NPDES Stormwater permit (NCS000250) outlines certain objectives and management measures pertaining to construction activities. The permit references *NCG010000, General Permit to Discharge Stormwater* under the NPDES, and states that the Department shall incorporate the applicable requirements into its delegated Erosion and Sediment Control Program for construction activities disturbing one or more acres of land. The Department further incorporates these requirements on all contracted bridge and culvert work at jurisdictional waters, regardless of size. Some of the requirements are, but are not limited to:
- (a) Control project site waste to prevent contamination of surface or ground waters of the state, i.e. from equipment operations/maintenance construction materials, concrete washout, chemicals, litter, fuels, lubricants, coolants, hydraulic fluids, any other petroleum products, and sanitary waste.
 - (b) Inspect erosion and sediment control / stormwater devices and stormwater discharge outfalls at least once every 7 calendar days, twice weekly for construction related Federal Clean Water Act, Section 303(d) impaired streams with turbidity violations, and within 24 hours after a significant rainfall event of 0.5 inches within a 24-hour period.
 - (c) Maintain an onsite rain gauge or use the Department's Multi-Sensor Precipitation Estimate website to maintain a daily record of rainfall amounts and dates.
 - (d) Maintain erosion and sediment control / stormwater inspection records for review by Department and Regulatory personnel upon request.
 - (e) Implement approved reclamation plans on all borrow pits, waste sites and staging areas.
 - (f) Maintain a log of turbidity test results as outlined in the Department's Procedure for Monitoring Borrow Pit Discharge.
 - (g) Provide secondary containment for bulk storage of liquid materials.
 - (h) Provide training for employees concerning general erosion and sediment control / stormwater awareness, the Department's NPDES Stormwater Permit NCS000250 requirements, and the requirements of the *General Permit, NCG010000*.

- (i) Report violations of the NPDES permit to the Engineer immediately who will notify the Division of Water Quality Regional Office within 24 hours of becoming aware of the violation.
- (3) Quality Control Program - Maintain a quality control program to control erosion, prevent sedimentation and follow provisions/conditions of permits. The quality control program shall:
- (a) Follow permit requirements related to the Design-Build Team and subcontractors' construction activities.
 - (b) Ensure that all operators and / or subcontractor(s) on site have the proper erosion and sediment control / stormwater certification.
 - (c) Notify the Engineer when the required certified erosion and sediment control / stormwater personnel are not available on the job site when needed.
 - (d) Conduct the inspections required by the NPDES permit.
 - (e) Take corrective actions in the proper timeframe as required by the NPDES permit for problem areas identified during the NPDES inspections.
 - (f) Incorporate erosion control into the work in a timely manner and stabilize disturbed areas with mulch / seed or vegetative cover on a section-by-section basis.
 - (g) Use flocculants approved by state regulatory authorities where appropriate and where required for turbidity and sedimentation reduction.
 - (h) Ensure proper installation and maintenance of temporary erosion and sediment control devices.
 - (i) Remove temporary erosion or sediment control devices when they are no longer necessary as agreed upon by the Engineer.
 - (j) The Design-Build Team's quality control and inspection procedures shall be subject to review by the Engineer. Maintain NPDES inspection records and make records available at all times for verification by the Engineer.
- (B) *Certified Foreman* - At least one Certified Foreman shall be onsite for each type of work listed herein during the respective construction activities to control erosion, prevent sedimentation and follow permit provisions:
- (1) Foreman in charge of grading activities
 - (2) Foreman in charge of bridge or culvert construction over jurisdictional areas
 - (3) Foreman in charge of utility activities

The Design-Build Team may request to use the same person as the Level II Supervisor and Level II Foreman. This person shall be onsite whenever construction activities as described above are taking place. This request shall be approved by the Engineer prior to work beginning.

The Design-Build Team may request to name a single Level II Foreman to oversee multiple construction activities on small bridge or culvert replacement projects. This request shall be approved by the Engineer prior to work beginning.

(C) *Certified Installers* - Provide at least one onsite, Level I Certified Installer for each of the following erosion and sediment control / stormwater crew:

- (1) Seeding and Mulching
- (2) Temporary Seeding
- (3) Temporary Mulching
- (4) Sodding
- (5) Silt fence or other perimeter erosion / sediment control device installations
- (6) Erosion control blanket installation
- (7) Hydraulic tackifier installation
- (8) Turbidity curtain installation
- (9) Rock ditch check / sediment dam installation
- (10) Ditch liner / matting installation
- (11) Inlet protection
- (12) Riprap placement
- (13) Stormwater BMP installations (such as but not limited to level spreaders, retention / detention devices)
- (14) Pipe installations within jurisdictional areas

If a Level I *Certified Installer* is not onsite, the Design-Build Team may substitute a Level II Foreman for a Level I Installer, provided the Level II Foreman is not tasked to another crew requiring Level II Foreman oversight.

(D) *Certified Designer* – Include the certification number of the Level III-B Certified Designer on the erosion and sediment control / stormwater component of all reclamation plans and if applicable, the certification number of the Level III-A Certified Designer on the design of the project erosion and sediment control / stormwater plan.

Preconstruction Meeting

Furnish the names of the *Certified Erosion and Sediment Control / Stormwater Supervisor, Certified Foremen, Certified Installers and Certified Designers* and notify the Engineer in writing of changes in certified personnel over the life of the contract within 2 days of change.

Ethical Responsibility

Any company performing work for the North Carolina Department of Transportation has the ethical responsibility to fully disclose any reprimand or dismissal of an employee resulting from improper testing or falsification of records.

Revocation or Suspension of Certification

Upon recommendation of the Chief Engineer - Operations to the certification entity, certification for Supervisor, Certified Foreman, Certified Installer and Certified Designer may be revoked or suspended with the issuance of an Immediate Corrective Action (ICA), Notice of Violation (NOV), or Cease and Desist Order for erosion and sediment control / stormwater related issues.

The Chief Engineer may recommend suspension or permanent revocation of such certification due to the following:

- (A) Failure to adequately perform the duties as defined within the certification provision
- (B) Issuance of an ICA, NOV, or Cease and Desist Order
- (C) Failure to fully perform environmental commitments as detailed within the permit conditions and specifications
- (D) Demonstration of erroneous documentation or reporting techniques
- (E) Cheating or copying another candidate's work on an examination
- (F) Intentional falsification of records
- (G) Directing a subordinate under direct or indirect supervision to perform any of the above actions
- (H) Dismissal from a company for any of the above reasons
- (I) Suspension or revocation of one's certification by another entity

Suspension or revocation of a certification will be sent by certified mail to the certificant and the Corporate Head of the company that employs the certificant.

A certificant has the right to appeal any adverse action which results in suspension or permanent revocation of certification by responding, in writing, to the Chief Engineer within 10 calendar days after receiving notice of the proposed adverse action.

Chief Engineer - Operations
1537 Mail Service Center
Raleigh, NC 27699-1537

Failure to appeal within 10 calendar days will result in the proposed adverse action becoming effective on the date specified on the certified notice. Failure to appeal within the time specified will result in a waiver of all future appeal rights regarding the adverse action taken. The certificant will not be allowed to perform duties associated with the certification during the appeal process.

The Chief Engineer will hear the appeal and make a decision within 7 days of hearing the appeal. The decision of the Chief Engineer will be final and will be made in writing to the certificant.

If a certification is temporarily suspended, the certificant shall pass any applicable written examination and any proficiency examination, at the conclusion of the specified suspension period, prior to having the certification reinstated.

Measurement and Payment

Certified Erosion and Sediment Control / Stormwater Supervisor, Certified Foremen, Certified Installers and Certified Designer will be incidental to the project for which no direct compensation will be made.

PROCEDURE FOR MONITORING BORROW PIT DISCHARGE

(02-20-07)

DB1 G181

Water discharge from borrow pit sites shall not cause surface waters to exceed 50 NTUs (nephelometric turbidity unit) in streams not designated as trout waters and 10 NTUs in streams, lakes or reservoirs designated as trout waters. For lakes and reservoirs not designated as trout waters, the turbidity shall not exceed 25 NTUs. If the turbidity exceeds these levels due to natural background conditions, the existing turbidity level shall not be increased.

If during any operating day, the downstream water quality exceeds the standard, the Design-Build Team shall do all of the following:

- (A) Either cease discharge or modify the discharge volume or turbidity levels to bring the downstream turbidity levels into compliance, or
- (B) Evaluate the upstream conditions to determine if the exceedance of the standard is due to natural background conditions. If the background turbidity measurements exceed the standard, operation of the pit and discharge can continue as long as the stream turbidity levels are not increased due to the discharge.
- (C) Measure and record the turbidity test results (time, date and sampler) at all defined sampling locations 30 minutes after startup and at a minimum, one additional sampling of all sampling locations during that 24-hour period in which the borrow pit is discharging.
- (D) Notify DWQ within 24 hours of any stream turbidity standard exceedances that are not brought into compliance.

During the Environmental Assessment required by Article 230-4 of the *Standard Specifications*, the Design-Build Team shall define the point at which the discharge enters into the State's surface waters and the appropriate sampling locations. Sampling locations shall include points upstream and downstream from the point at which the discharge enters these waters. Upstream sampling location shall be located so that it is not influenced by backwater conditions and represents natural background conditions. Downstream sampling location shall be located at the point where complete mixing of the discharge and receiving water has occurred.

The discharge shall be closely monitored when water from the dewatering activities is introduced into jurisdictional wetlands. Any time visible sedimentation (deposition of sediment) on the wetland surface is observed, the dewatering activity shall be suspended until turbidity levels in the stilling basin can be reduced to a level where sediment deposition does not occur. Staining of wetland surfaces from suspended clay particles, occurring after evaporation or infiltration, does not constitute sedimentation. No activities shall occur in wetlands that adversely affect the

functioning of a wetland. Visible sedimentation shall be considered an indication of possible adverse impacts on wetland use.

The Engineer shall perform independent turbidity tests on a random basis. These results shall be maintained in a log within the project records. Records will include, at a minimum, turbidity test results, time, date and name of sampler. Should the Department's test results exceed those of the Design-Build Team's test results, an immediate test shall be performed jointly with the results superseding the previous test results of both the Department and the Design-Build Team.

The Design-Build Team shall use the *NCDOT Turbidity Reduction Options for Borrow Pits Matrix*, available at <http://www.ncdot.org/doh/preconstruct/ps/contracts/letting.html> to plan, design, construct, and maintain BMPs to address water quality standards. Tier I Methods include stilling basins which are standard compensatory BMPs. Other Tier I methods are noncompensatory and shall be used when needed to meet the stream turbidity standards. Tier II Methods are also noncompensatory and are options that may be needed for protection of rare or unique resources or where special environmental conditions exist at the site which have led to additional requirements being placed in the DWQ's 401 Certifications and approval letters, Isolated Wetland Permits, Riparian Buffer Authorization or a DOT Reclamation Plan's Environmental Assessment for the specific site. Should the Design-Build Team exhaust all Tier I Methods on a site exclusive of rare or unique resources or special environmental conditions, Tier II Methods may be required by regulators on a case by case basis per supplemental agreement.

The Design-Build Team may use cation exchange capacity (CEC) values from proposed site borings to plan and develop the Price Proposal for the project. CEC values exceeding 15 milliequivalents per 100 grams of soil may indicate a high potential for turbidity and should be avoided when dewatering into surface water is proposed.

No additional compensation for monitoring borrow pit discharge will be paid.

CULVERT PIPE

(01-19-10)

DB10R32

Revise the 2006 *Standard Specifications for Roads and Structures* as follows:

Page 10-67, Article 1032-1, replace (A), (B), (C), (E) and (F) with the following:

- (A) Coated corrugated metal culvert pipe and pipe arches.
- (B) Coated corrugated metal end sections, coupling band and other accessories
- (C) Corrugated aluminum alloy structural plate pipe and pipe arches
- (D) Corrugated aluminum alloy end sections, coupling band and other accessories
- (E) Welded steel pipe

Page 10-69, Subarticle 1032-3(A)(5) Coating Repair, replace with the following:

Repair shall be in accordance with Section 1076-6 of the 2006 *Standard Specifications for Roads and Structures*.

Subarticle 1032-3(A)(7) Aluminized Pipe, replace with the following:

Aluminized pipe shall meet all requirements herein, except that the pipe and coupling bands shall be fabricated from aluminum coated steel sheet meeting the requirements of AASHTO M274.

Page 10-71, Article 1032-4 Coated Culvert Pipe, replace (A), (1), (2), (3), (4), (B), (C), (D), (E), (F) and (G) with the following:**(A) Coatings for Steel Culvert Pipe or Pipe Arch**

The below coating requirements apply for steel culvert pipe, pipe arch, end sections, tees, elbows and eccentric reducers.

- (1) Steel Culvert Pipe shall have an aluminized coating, meeting the requirement of AASHTO M274.
- (2) When shown on the plans developed by the Design-Build Team, and as approved by the Engineer, a polymeric coating meeting the requirements of AASHTO M246 for Type B coating may be substituted for aluminized coating.

(B) Acceptance

Acceptance of coated steel culvert pipe, and its accessories, shall be based on, but not limited to, visual inspections, classification requirements, check samples taken from material delivered to the project, and conformance to the annual Brand Registration.

Page 10-73, Article 1032-5, sixth paragraph, third sentence, remove the word "spelter"**Page 10-74, 1032-7 Vitrified Clay Culvert Pipe, delete section in its entirety.****Page 10-75, Article 1032-8 Welded Steel Pipe, change title to WELDED STEEL PIPE FOR DRAINAGE****Subarticle 1032-9(B) Plain Concrete Culvert Pipe, delete section in its entirety.****Page 10-77, Article 1032-10 Corrugated Polyethylene Culvert Pipe, change title to CORRUGATED POLYETHYLENE (HDPE) CULVERT PIPE****Add the following: Article 1032-11 Polyvinyl Chloride (PVC) Pipe**

Polyvinyl Chloride pipe shall conform to AASHT M 304 or ASTM 949. When rubber gaskets are to be installed in the pipe joint, the gasket shall be the sole element relied on to maintain a tight joint. Test pipe joints at the plant hydrostatically using test methods in ASTM D 3212. Soil tight joints shall be watertight to 13.8 kPA. Watertight joints shall be watertight to 34.5 kPA unless a higher pressure rating is specified in the plans developed by the Design-Build Team.

DRAINAGE PIPE

(03-16-10)

DB3 R36

Description

Where shown in the plans developed by the Design-Build Team, the Contractor shall use Reinforced Concrete Pipe, Corrugated Aluminum Alloy Pipe, Aluminized Corrugated Steel Pipe, Corrugated Polyethylene Pipe (HDPE Pipe) or Polyvinyl-Chloride Pipe (PVC Pipe) in accordance with the following requirements:

Material

Item	Section
Corrugated Aluminum Alloy Pipe	1032-2(A)
Aluminized Corrugated Steel Pipe	1032-3(A)(7)
Corrugated Polyethylene Pipe (HDPE)	1032-10
Reinforced Concrete Pipe – Class II or III	1032-9(C)
Polyvinyl-Chloride (PVC)	1032-11
Elbows	1032

Corrugated Steel Pipe shall not be permitted in counties listed in the Pipe Installation and Pipe Culverts Special Provision. In other counties, Corrugated Steel Pipe requires an acceptable coating in accordance with Section 1032-4 of the 2006 *Standard Specifications for Roads and Structures*.

Only pipe with smooth inside walls shall be allowed for storm drain systems. Storm drain systems are defined as pipe under curb and gutter, expressway gutter, and shoulder berm gutter that connects drainage structures and is not open ended.

All pipe types are subject to the maximum and minimum fill height requirements as found on Roadway Standard Detail 300D01 - Sheet 3 of 3. The appropriate Reinforced Concrete Pipe class and the appropriate gage thickness for Corrugated Aluminum Alloy Pipe and Aluminized Corrugated Steel Pipe shall be selected based on fill height.

Site specific conditions may limit a particular material beyond what is identified in this Special Provision. These conditions include, but are not limited to, abrasion, environmental, soil resistivity and pH, high ground water and special loading conditions. The Design-Build Team shall determine if additional restrictions are necessary.

Allowable side drain pipe material is outlined in Article 310-4 of the Pipe Installation and Pipe Culverts Special Provision.

Slope drains shall be Corrugated Aluminum Alloy Pipe, Aluminized Corrugated Steel Pipe, Corrugated Polyethylene Pipe (HDPE Pipe) or Polyvinyl-Chloride Pipe (PVC Pipe).

Transverse median drains, storm drainage system pipes, and open-ended cross drains shall be Reinforced Concrete Pipe unless the pipe slope is greater than 10%, in which case the pipe shall be either Corrugated Aluminum Alloy Pipe or Aluminized Corrugated Steel Pipe.

Construction Methods

Pipe Culverts shall be installed in accordance with the plans developed by the Design-Build Team, this RFP and the 2006 *Standard Specifications for Roads and Structures*.

Where allowed by the plans developed by the Design-Build Team, use any of the several alternate pipes shown herein, but only one type of pipe shall be permitted between drainage structures or for the entire length of a cross line pipe.

PIPE INSTALLATION AND PIPE CULVERTS

(01-19-10)

DB3R40

Revise the 2006 *Standard Specifications for Roads and Structures* as follows:

Replace Section 300 and Section 310 with the following:

SECTION 300

PIPE INSTALLATION

300-1 DESCRIPTION

Excavate, undercut, provide material, condition foundation, lay pipe, joint and couple pipe sections, and furnish and place all backfill material as necessary to install the various types of pipe culverts and fittings required to complete the project.

Install pipe in accordance with the detail in the plans developed by the Design-Build Team.

Do not waste excavation unless permitted. Use suitable excavated material as backfill; or in the formation of embankments, subgrades, and shoulders; or as otherwise directed. Furnish disposal areas for the unsuitable material. The Engineer will identify excavated materials that are unsuitable.

Where traffic is to be maintained, install pipe in sections so that half the width of the roadway is available to traffic.

300-2 MATERIALS

Refer to Division 10:

Item	Section
Flowable Fill	1000
Select Materials	1016
Joint Materials	1032-9(G)
Engineering Fabric	1056-1

Provide foundation conditioning material meeting the requirements of Article 1016-3 for Class V or VI as shown on the plans developed by the Design-Build Team.

Provide bedding material meeting the requirements of Article 1016-3 for Class II (Type 1 only) or Class III as shown on the plans developed by the Design-Build Team.

Provide backfill material meeting the requirements of Article 1016-3 for Class II (Type 1 only) or Class III material as shown on the plans developed by the Design-Build Team.

Do not use corrugated steel pipe in the following counties:

Beaufort, Bertie, Bladen, Brunswick, Camden, Carteret, Chowan, Columbus, Craven, Currituck, Dare, Gates, Hertford, Hyde, Jones, Martin, New Hanover, Onslow, Pamlico, Pasquotank, Pender, Perquimans, Tyrrell and Washington.

300-3 UNLOADING AND HANDLING

Unload and handle pipe with reasonable care. Do not roll or drag metal pipe or plates over gravel or rock during handling. Take necessary precautions to ensure the method used in lifting or placing the pipe does not induce stress fatigue in the pipe. Use a lifting device that uniformly distributes the weight of the pipe along its axis or circumference. Repair minor damage to pipe when permitted. Remove pipe from the project that is severely damaged or is rejected as being unfit for use. Undamaged portions of a joint or section may be used where partial lengths are required.

300-4 PREPARATION OF PIPE FOUNDATION

Prepare the pipe foundation in accordance with the applicable method as shown on the plans developed by the Design-Build Team, true to line and grade, and uniformly firm.

Camber invert grade an amount sufficient to prevent the development of sag or back slope in the flow line. The Design-Build Team shall determine the amount of camber required and submit to the Engineer for approval.

Where material is found to be of poor supporting value or of rock and when the Engineer cannot make adjustment in the location of the pipe, undercut existing foundation material within the limits established on the plans developed by the Design-Build Team. Backfill the undercut with foundation conditioning material, Class V or VI select material. Encapsulate the foundation conditioning material with Type 4 engineering fabric prior to placing bedding material. Overlap all transverse and longitudinal joints in the fabric at least 18 inches.

Maintain the pipe foundation in a dry condition.

300-5 INVERT ELEVATIONS

No adjustment in contract time or compensation shall be granted for pipe field adjustments.

300 -6 LAYING PIPE

The Department reserves the right to perform forensic testing on any installed pipe.

(A) Rigid Pipe

Concrete and welded steel pipe shall be considered rigid pipe. Lay pipe on prepared foundation, bell or groove end upgrade with the spigot or tongue fully inserted. Check each joint for alignment and grade as the work proceeds.

Use flexible plastic joint material except when material of another type is specified on the plans developed by the Design-Build Team. Joint material of another type may be used when permitted.

Repair lift holes in concrete pipe, if present. Thoroughly clean and soak the lift hole and completely fill the void with an approved non-shrink gout. Submit alternate details for repairing lift holes to the engineer for review and approval.

For all pipes 42 inches in diameter and larger, wrap filter fabric around all pipe joints. Use Type 2 Class B fabric. Extend fabric at least 12 inches beyond each side of the joint. Secure the filter fabric against the outside of the pipe by methods approved by the Engineer.

(B) Flexible Pipe (Except Structural Plate Pipe)

Corrugated steel, corrugated aluminum, corrugated polyethylene (HDPE), and polyvinylchloride (PVC) pipe shall be considered flexible pipe. Place flexible pipe carefully on the prepared foundation starting at the downstream end with the inside circumferential laps pointing downstream and with the longitudinal laps at the side or quarter points.

Handle coated corrugated steel pipe with special care to avoid damage to coatings.

Join pipe sections with coupling band, fully bolted and properly sealed. Provide coupling bands for annular and helical corrugated metal pipe with circumferential and longitudinal strength sufficient to preserve the alignment, prevent separation of the sections, and prevent backfill infiltration. Match-mark all pipe 60 inches or larger in diameter at the plant for proper installation on the project.

At locations indicated on the plans developed by the Design-Build Team, corrugated steel pipe sections shall be jointed together with rod and lug coupling bands, fully bolted. Sleeve gaskets shall be used in conjunction with rod and lug couplings and the joints properly sealed. Coupling bands shall provide circumferential and longitudinal strength sufficient to preserve the alignment, prevent separation of the sections and prevent infiltration of backfill material.

300-7 BEDDING AND BACKFILLING

Loosely place bedding material, in a uniform layer, a depth equal to the inside diameter of the pipe divided by six or six inches, whichever is greater. Leave bedding material directly beneath

the pipe uncompacted and allow pipe seating and backfill to accomplish compaction. Excavate recesses to receive the bells where bells and spigot type pipe is used.

Place fill around the pipe in accordance with the applicable method shown on the plans developed by the Design-Build Team in layers not to exceed 6 inches loose unless otherwise permitted. Compact to the density required by Subarticle 235-4(C). Approval of the backfill material is required prior to its use. Use select material as shown on the plans developed by the Design-Build Team.

Take care during backfill and compaction operations to maintain alignment and prevent damage to the joints. Keep backfill free from stones, frozen lumps, chunks of highly plastic clay, or other objectionable material.

Grade and maintain all pipe backfill areas in such a condition that erosion or saturation will not damage the pipe foundation or backfill.

Excavatable flowable fill may be used for backfill when approved by the Engineer. When using excavatable flowable fill, ensure that the pipe is not displaced and does not float during backfill. Submit methods for supporting the pipe and material placement to the Engineer for review and approval.

Do not operate heavy equipment over any pipe until it has been properly backfilled with a minimum three feet of cover. Place, maintain, and finally remove the required cover that is above the proposed finished grade at no cost to the Department. Remove and replace, at no cost to the Department, pipe that becomes misaligned, shows excessive settlement, or has been otherwise damaged by the Design Build Team's operations.

300-8 INSPECTION AND MAINTENANCE

Prior to final acceptance, the Engineer will perform random video camera and or mandrel inspections to ensure proper jointing and that deformations do not exceed allowable limits. Replace pipes having cracks greater than 0.1 inches or deflections greater than 7.5 percent. Repair or replace pipes with cracks greater than 0.01 inches, exhibiting displacement across a crack, exhibiting bulges, creases, tears, spalls, or delamination. Maintain all pipe installations in a condition such that they shall function continuously from the time the pipe is installed until the project is accepted.

300-9 MEASUREMENT AND PAYMENT

No separate payment will be made for any costs incurred for compliance with this Special Provision. All material and labor, including but not limited to foundation conditioning material, foundation conditioning fabric, select bedding and backfill material, pavement repair, and removal and disposal of existing pavement shall be included in the lump sum price bid for the entire project.

SECTION 310**PIPE CULVERTS****310-1 DESCRIPTION**

Furnish and install drainage pipe at locations and size called for in the plans developed by the Design-Build Team. The work includes construction of joints and connections to other pipes, endwalls and drainage structures.

310-2 MATERIALS

Refer to Division 10:

Item	Section
Plain Concrete Pipe Culvert	1032-9(B)
Reinforced Concrete Pipe Culvert	1032-9(C)
Precast Concrete Pipe End Sections	1032-9(D)
Concrete Pipe Tees and Elbows	1032-9(E)
Corrugated Aluminum Alloy Pipe Culvert	1032-2(A)
Corrugated Aluminum Alloy Pipe Tees and Elbows	1032-2(B)
Corrugated Steel Culvert Pipe and Pipe Arch	1032-3(A)
Prefabricated Corrugated Steel Pipe End Sections	1032-3(B)
Corrugated Steel Pipe Tees and Elbows	1032-3(C)
Corrugated Steel Eccentric Reducers	1032-3(D)
HDPE Smooth Lined Corrugated Plastic Pipe	1032-10B
Polyvinylchloride (PVC) Pipe	1032-11(B)

Suppliers that provide metal pipe culverts, fittings and all other accessories covered by this section shall meet the requirements of the Department's Brand Certification program for metal pipe culverts, and be listed on the Department's pre-approved list for suppliers of metal pipe culvert.

Do not use corrugated steel pipe in the following counties:

Beaufort, Bertie, Bladen, Brunswick, Camden, Carteret, Chowan, Columbus, Craven, Currituck, Dare, Gates, Hertford, Hyde, Jones, Martin, New Hanover, Onslow, Pamlico, Pasquotank, Pender, Perquimans, Tyrell and Washington.

310-3 PIPE INSTALLATION

Install pipe, pipe tees and elbows in accordance with Section 300 above.

310-4 SIDE DRAIN PIPE

Side drain pipe shall be defined as storm drain pipe running parallel to the roadway, to include pipe in medians, outside ditches, driveways, and under shoulder berm gutter along outside shoulders greater than four feet wide.

Where shown in the plans developed by the Design-Build Team, side drain pipe may be class II reinforced concrete pipe, aluminized corrugated steel pipe, corrugated aluminum alloy pipe, HDPE pipe or PVC pipe. Corrugated steel pipe shall be restricted in the counties listed in Article 310-2 above. Install side drain pipe in accordance with Section 300 above. Cover for side drain pipe shall be at least one foot.

310-5 PIPE END SECTIONS

Choose which material to use for the required end sections. Both corrugated steel and concrete pipe end sections will be allowed on concrete pipe, corrugated steel pipe and HDPE smooth lined corrugated plastic pipe.

310-6 MEASUREMENT AND PAYMENT

No separate payment will be made for items covered by this Special Provision. All material and labor, including but not limited to linear feet of pipe, select bedding, backfill material, pipe end sections, tees, elbows and eccentric reducers, shall be included in the lump sum price bid for the entire project.

CEMENT AND LIME STABILIZATION OF SUB-GRADE SOILS

(07-12-07)

DB5 R21

General

The Design-Build Team shall be responsible for the following:

1. Performing all laboratory tests in a laboratory certified by the AMRL / NCDOT Laboratory Proficiency Program
2. Sampling Sub-grade soils
3. Conducting Laboratory tests to determine:
 - a. Soil classifications
 - b. Moisture-density relationships
 - c. Quantity of lime or cement required to achieve specified strengths
4. Designating areas to be stabilized by either lime or cement and the required rates of application
5. Conducting field tests to determine unconfined compressive strength

Sampling

The Design-Build Team shall take soil samples, after the project has been graded to within 2 inches of final sub-grade elevation. The Design-Build Team shall sample the top 8 inches at a minimum frequency of one sample per 1,000 feet, per each lane, for classification tests; and one sample per 3,000 feet, per each lane, for moisture density tests and lime or cement mix design tests. Additional samples shall be taken to ensure that all the predominant soil types, limits of distribution of these soils and different site conditions have been represented.

Classification Tests

The Design-Build Team shall perform the following tests to determine AASHTO classifications of different soils in accordance with AASHTO specifications as modified by NCDOT. Copies of these modified procedures can be obtained from Materials and Test Unit's Soils Laboratory.

TABLE 1

<u>TEST</u>	<u>AASHTO DESIGNATION</u>
Dry Preparation of Disturbed Soils	T-87
Particle Size Analysis of Soils	T-88
Determining the Liquid Limit of Soils	T-89
Determining the Plastic Limit and Plasticity Index of Soils	T-90

Moisture Density Test

Based on the criteria set in Table 2, below, the Design-Build Team shall perform the Moisture Density Tests, using either lime or cement. The Design-Build Team shall use 10% cement by weight in soil cement and 4% lime by weight, in soil-lime mixtures. The Design-Build Team shall conduct the tests in accordance with AASHTO T-99, and T-134 for soil-lime and soil-cement mixtures, respectively. In each case, The Design-Build Team shall determine the maximum dry density and optimum moisture content.

TABLE 2

<u>CRITERIA FOR SELECTING LIME OR CEMENT</u>		
PROPERTY	A	B
Percent passing #200 Sieve	35 Max	36 Min
Liquid Limit	40 Max	41 Min
Plasticity Index	10 Max	25 Min

The Design-Build Team shall use cement for all soils meeting criteria in Column A and lime for all soils meeting criteria in Column B. The Design-Build Team may choose either lime or cement for all soils not meeting all criteria in either Column A or B.

DETERMINING THE APPLICATION RATES FOR SOIL-CEMENT AND SOIL-LIME MIXTURES

Soil-Cement Mixtures

For soil-cement mixtures, the Design-Build Team shall be required to do the following:

- Make specimens at optimum moisture content using a quantity of cement in the range of 5 to 12 percent by weight.
- Compact the specimens to a minimum density of 95% of maximum dry density obtained using AASHTO T 134.
- Make a minimum of 2 specimens for each selected cement rate.
- Cure the specimens for 7 days in a moist room maintained at a temperature of $73^{\circ}\text{F} \pm 2.7^{\circ}$ and a humidity of 100%. At the end of the curing period, immerse the specimens in water for 4 hours.
- After immersion, test the specimens in unconfined compression in accordance with ASTM D 1633.
- Report the maximum strength obtained and the corresponding percent strain.
- Select the rate of cement that provides a minimum unconfined compressive strength of 200 psi and a maximum of 400 psi.

Soil-Lime Mixtures

For soil-lime mixtures, the Design-Build Team shall be required to do the following:

- Make specimens at optimum moisture content using a quantity of lime in the range of 3.5 to 6.5 percent by weight.
- Compact specimens to a minimum density of 95% of maximum dry density obtained by AASHTO T99.
- Make a minimum of two specimens for each selected lime rate.
- Cure the specimens in sealed plastic bags for 48 hours in an oven at a temperature of 118 °F. Do not immerse the specimens in water at the end of the curing period.
- Test the specimens in unconfined compression in accordance with AASHTO T 208. Report the maximum strength obtained and the corresponding percent strain.
- Select the rate of lime that provides a minimum unconfined compressive strength of 60 psi.

Submittals for Review and Approval Prior to Construction

The Design-Build Team shall adhere to the following submittal guidelines:

- Submit all laboratory test results for review.
- Submit a sketch in plan view showing areas of the project to be stabilized by either lime or cement and application rates for each stabilizer.
- Submit any other documentation that supports the Design-Build Team's recommendations.

Construction of Lime Treated Subgrade

The Design-Build Team shall construct the lime treated sub-grade as specified in Section 501 of the North Carolina Department of Transportation *2006 Standard Specifications for Roads and Structures* with the following exceptions:

Subsection 501-4 Equipment

Contractor's equipment will not require engineer's approval.

Subsection 501-8 (A) General

Paragraph #1 is not applicable to this project.

Subsection 501-9 (B) Preliminary Curing

Amend as follows: Allow a minimum of 2 days and a maximum of 4 days for preliminary curing.

Subsection 501-10 Compacting, Shaping, and Finishing

Last paragraph is not applicable.

Subsection 501-11 Thickness

Last two paragraphs are not applicable.

Subsection 501-15 Method of Measurement

The entire sub-sections are not applicable.

Subsection 501-16 Basis of Payment

The entire sub-section is not applicable.

Construction of Cement Treated Subgrade

The Design-Build Team shall construct the soil cement sub-grade as specified in section 542 of the North Carolina Department of Transportation *2006 Standard Specifications for Roads and Structures*, with the following exceptions:

Subsection 542-4 Equipment

Contractor's equipment will not require Engineer's approval.

Subsection 542-7 Application of Cement

First paragraph is not applicable.

Subsection 542-11 Thickness

Paragraphs 2 and 3 are not applicable.

Subsection 542-16 Method of Measurement

This entire sub-section is not applicable.

Subsection 542-17 Basis of Payment

This entire sub-section is not applicable.

Unconfined Compressive Strength

The Design-Build Team shall allow a minimum of seven days curing before testing for strength.

The lime-stabilized subgrades shall be tested using Dynamic Cone Penetrometer (DCP) in accordance with *Quality Assurance Testing of Lime-Treated Soils Utilizing the Dynamic Cone Penetrometer*, Test Method #1-2005. The Design-Build Team shall adhere to the testing equipment requirements and procedures as outlined in *Dynamic Cone Penetrometer Testing for Subgrade Stability* except that the minimum penetration depth shall be eight inches. Upon request, a copy of the aforementioned documents can be obtained from the NCDOT Geotechnical Engineering Unit. The required unconfined compressive strength for lime shall be 60 psi, which corresponds to a penetration per blow of approximately 0.5 inches of the Dynamic Cone Penetrometer.

For cement-stabilized subgrades, the Design-Build Team shall make field specimens, cure them for seven days and test them in the laboratory. The minimum and maximum required unconfined compressive strength for soil cement shall be 200 psi and 400 psi, respectively.

For both lime and cement stabilized subgrades, one test shall be required for every 400 feet per lane width at random locations selected using random number tables.

Submittals for Review During Construction

The Design-Build Team shall submit the unconfined compressive strength and dynamic cone penetrometer test results for review and acceptance.

PRICE ADJUSTMENTS FOR ASPHALT BINDER

(07-21-09)

DB6 R25

Price adjustments for asphalt binder for plant mix will be made in accordance with Section 620 of the 2006 *Standard Specifications for Roads and Structures*.

When it is determined that the monthly selling price of asphalt binder on the first business day of the calendar month during which the last day of the partial payment period occurs varies either upward or downward from the Base Price Index, the partial payment for that period will be

adjusted. The partial payment will be adjusted by adding the difference (+ or -) of the base price index subtracted from the monthly selling price multiplied by the total theoretical quantity of asphalt binder authorized for use in the plant mix placed during the partial payment period involved.

The base price index for asphalt binder for plant mix is \$ _____ per ton.

This base price index represents an average of F.O.B. selling prices of asphalt binder at supplier's terminals on _____.

PRICE ADJUSTMENTS - ASPHALT CONCRETE PLANT MIX

(04-03-07)

DB6 R26

Revise the 2006 *Standard Specifications for Roads and Structures* as follows:

Page 6-27, Article 609-8 and Page 6-49, Article 610-13

Add the following paragraph before the first paragraph:

The "Asphalt Price" used to calculate any price adjustments set forth in this section shall be \$35 per theoretical ton. This price shall apply for all mix types.

FIELD OFFICE

(6-1-07)

DB 08-01

Description

This work consists of furnishing, erecting, equipping, and maintaining a field office for the exclusive use of Department Engineers and Inspectors at a location on the project approved by the Engineer. Provide a field office that complies with the current A.D.A. Design and Accessibility Standards, the National Electric Code, local, state, and federal regulations, and the following:

Procedures

The field office and equipment shall remain the property of the Design-Build Team upon completion of the contract. The field office must be separated from buildings and trailers used by the Design-Build Team and be erected and functional as an initial operation. Failure to have the field office functional when work first begins on the project will result in withholding payment of the Design-Build Team's monthly progress estimate. The field office must be operational throughout the duration of the project and be removed upon completion and final acceptance of the project.

Provide a field office that is weatherproof, tightly floored and roofed, constructed with an air space above the ceiling for ventilation, supported above the ground, has a width of at least 10 feet, and the floor-to-ceiling height that is at least 7 feet 6 inches. Provide inside walls and a ceiling that are constructed of plywood, masonite, gypsum board, or other suitable materials. Have the exterior walls, ceiling, and floor insulated.

Provide a field office with a minimum floor space of 500 square feet and that is equipped with the following:

<u>Number</u>	<u>Item</u>
1	Double-pedestal desk (approximately 60 by 34 inches, at least 2,000 square inches)
1	Plan and drafting table (approximately 30 by 96 inches) with adjustable stool
1	Computer table having a minimum size of 48 by 30 by 29 inches
1	Plan rack for 24 by 36 inch drawings with 6 plan clamps
1	Printing calculator
2	2-drawer fire protection file, 15 inch drawer width, minimum UL rating of Class 350
6	Office chairs with a minimum of two having casters
2	Wastebaskets
1	Pencil sharpener
1	Copy machine (8 inch x 11 inch copies)
1	Telephone
1	Fax Machine
1	Answering machine

Windows and Doors

Provide a field office with at least three windows, with blinds, each having an area of at least 540 square inches, capable of being easily opened and secured from the inside and having at least two exterior passage doors. Provide doors at least 30 inches in width and 78 inches in height. Provide screens for windows and doors. Equip exterior passage door(s) with lock(s), and furnish at least two keys to the Engineer or inspector.

Steps

Provide accessibility in compliance with the current A. D. A. Design and Accessibility Standards, and the State Building Code and maintain them free from obstructions.

Storage Facility For Nuclear Gage

Furnish the field office with an outside storage facility for the Department's nuclear gage. The storage facility shall not be located within 10 feet of any other structure including the field office.

Lighting, Heating, and Air Conditioning

The field office must have satisfactory lighting, electrical outlets, heating equipment, an exhaust fan, and an air conditioner connected to an operational power source. Provide at least one of the light fixtures that is a fluorescent light situated over the plan and drafting table. Furnish electrical current and fuel for heating equipment.

Fire Extinguishers

Furnish and maintain one fire extinguisher for each required exterior passage door. Fire extinguisher(s) may be chemical or dry powder. UL Classification 10-B:C (minimum), suitable for Type A:B:C: fires. Mount and maintain fire extinguisher(s) in accordance with OSHA Safety and Health Standards.

Toilets

Provide a toilet conforming to the requirements of the state and local boards of health or other bodies or courts having jurisdiction in the area. When separate facilities for men and women are not available, place a sign with the words "Rest Room" (with letters at least 1 inch in height) over the doorway, and provide an adequate positive locking system on the inside of the doorway. Maintain responsibility for the water and sewer connections or the installation and connection of a water well and septic tank and drain field. These facilities must conform to all local and state permits.

Utilities

Except for telephone service, make arrangement for necessary utility connections, maintain utilities, pay utility service fees and bills, and make arrangements for final disconnection of utilities. Furnish a telephone in each field office and permit the work necessary to install it. Installation and service fees for the telephone will be paid for by the Department.

Storage Facility for Test Equipment

Provide the field office with a storage facility, separate from the office for storage of test equipment, other than the nuclear gage. Provide a facility that has a minimum floor space of 64 square feet, is weatherproof, tightly floored and roofed, and has a tamper resistant key operated lock.

Miscellaneous Items

The field office must also include the following:

1. A certification that the office is free of asbestos and other hazardous materials.
2. A broom, dust pan, mop and bucket, and general cleaning supplies.
3. Provide and maintain an all weather parking area for six vehicles, including graveled access to the paved surface.

OVERHEAD SIGN SUPPORTS

(05-05-10)

DB11 R012

Description

Design, fabricate, furnish and erect various types of overhead sign assemblies. The types of overhead sign assemblies included in this specification are span structures, cantilever structures and sign structures attached to bridges.

Materials

Structural Steel.....Section 1072
 Overhead Structures.....Section 1096
 Signing Materials.....Section 1092
 Organic Zinc Repair PaintArticle 1080-9
 Reinforcing SteelSection 1070

Construction Methods

A. General

Fabricate overhead sign assemblies in accordance with the details shown in the approved working drawings and the requirements of these specifications.
 No welding, cutting or drilling in any manner shall be permitted in the field, unless prior approval by the Engineer is obtained.

Drill bolt holes and slots to finished size. Holes may also be punched to finished size, provided the diameter of the punched holes is at least twice the thickness of the metal being punched. Flame cutting of bolt holes and slots shall not be permitted.

Erect sign panels in accordance with the requirements for Type A or B signs as indicated in the plans or Roadway Standard Drawings. Field drill two holes per connection in the Z bars for attaching signs to overhead structures. Use two bolts at each connection.

Use two coats of a zinc-rich paint to touch up minor scars on all galvanized materials.

B. Shop Drawings

Design the overhead sign supports, including foundations, prior to fabrication. Submit computations and working drawings of the designs to the Engineer for review and acceptance.

Have a professional engineer registered in the State of North Carolina perform the computations and render a set of sealed, signed and dated drawings detailing the construction of each structure.

Submit to the Engineer for review and acceptance complete design and fabrication details for each overhead sign assembly, including foundations and brackets for supporting the signs and maintenance walkways. Base design upon the revised structure line drawings, wind load area and the wind speed shown in the plans, and in accordance with the *Standard Specifications for Structural Structures for Highway Signs, Luminaires and Traffic Signals*.

Submit thirteen (13) copies of completely detailed working drawings and one (1) copy of the design computations including all design assumptions for each overhead sign assembly to the Engineer for approval prior to fabrication. Working drawings shall

include complete design and fabrication details (including foundations); provisions for attaching signs, maintenance walkways (when applicable), applicable material specifications, and any other information necessary for procuring and replacing any part of the complete overhead sign assembly.

Allow 15 days for initial working drawing review after the Engineer receives them. If revisions to working drawings are required, an additional 15 days shall be required for review and approval of the final working drawings.

Approval of working drawings by the Engineer shall not relieve the Design-Build Team of responsibility for the correctness of the drawings, or for the fit of all shop and field connections and anchors.

C. Design and Fabrication

The following criteria governs the design of overhead sign assemblies:

Design shall be in accordance with the Standard Specifications for Structural Supports for Highway Signs, Luminaires and Traffic Signals, 4th Edition, 2001, and the latest Interim Specifications.

Within this Specification, there are several design criteria that are owner specified. They include:

- The wind pressure map that is developed from the 3-second gust speeds, as provided in Article 3.8, shall be used.
- Overhead cantilever sign structures shall include galloping loads (exclude four-chord horizontal trusses), truck-induced gust loading and natural wind gust loading in the fatigue design, as provided for in Article 11.7.1, 11.7.4 and 11.7.3 respectively.
- The fatigue importance category used in the design, for each type of structure, as provided for in Article 11.6, Fatigue Importance Factors, shall be Category II unless otherwise shown on the contract plans.

The following Specification interpretations or criteria shall be used in the design of overhead sign assemblies:

- For design of supporting upright posts or columns, the effective length factor for columns "K", as provided for in Appendix B, Section B.5, shall be taken as the following, unless otherwise approved by the Engineer:
 - Case 1 For a single upright post of cantilever or span type overhead sign structure, the effective column length factor, "K", shall be taken as 2.0.

Case 2 For twin post truss-type upright post with the post connected to one chord of a horizontal truss, the effective column length factor for that column shall be taken as 2.0.

Case 3 For twin post truss-type upright post with the post connected to two truss chords of a horizontal tri-chord or box truss, the effective column length factor for that column shall be taken as 1.65

- For twin post truss-type upright post, the unbraced length shall be from the chord to post connection to the top of base plate.
- For twin post truss-type upright post, that is subject to axial compression, bending moment, shear, and torsion the post shall satisfy *Standard Specifications for Structural Supports for Highway Signs, Luminaries and Traffic Signals* Equations 5-17, 5-18 and 5-19. To reduce the effects of secondary bending, in lieu of Equation 5-18, the following equation may be used:

$$\frac{f_a}{F_a} + \frac{f_b}{\left(1 - \frac{0.6f_a}{F_e}\right)F_b} + \left(\frac{f_v}{F_v}\right)^2 \leq 1.0$$

Where f_a = Computed axial compression stress at base of post

- The base plate thickness for all uprights and poles shall be a minimum of 2" but not less than that determined by the following criteria and design.

Case 1 Circular or rectangular solid base plates with the upright pole welded to the top surface of base plate with full penetration butt weld, and where no stiffeners are provided. A base plate with a small center hole, which is less than 1/5 of the upright diameter, and located concentrically with the upright pole, may be considered as a solid base plate.

The magnitude of bending moment in the base plate, induced by the anchoring force of each anchor bolt shall be, $M = (P \times D_1) / 2$.

Case 2 Circular or rectangular base plate with the upright pole socketed into and attached to the base plate with two lines of fillet weld, and where no stiffeners are provided, or any base plate with a center hole that is larger in diameter than 1/5 of the upright diameter

The magnitude of bending moment induced by the anchoring force of each anchor bolt shall be $M = P \times D_2$.

- M - bending moment at the critical section of the base plate induced by one anchor bolt
 - P - anchoring force of each anchor bolt
 - D_1 - horizontal distance between the center of the anchor bolt and the outer face of the upright, or the difference between the radius of the bolt circle and the outside radius of the upright
 - D_2 - horizontal distance between the face of the upright and the face of the anchor bolt nut
- The critical section shall be located at the face of the anchor bolt and perpendicular to the radius of the bolt circle. The overlapped part of two adjacent critical sections shall be considered ineffective.
 - The thickness of base plate of Case 1 shall not be less than that calculated based on formula for Case 2.
 - Uprights, foundations, and trusses that support overhead signs shall be designed in accordance with the Overhead Sign Foundation Project Special Provision found elsewhere in this RFP for the effects of torsion. Torsion shall be considered from dead load eccentricity of these attachments, as well as for attachments such as walkways, supporting brackets, lights, etc., that add to the torsion in the assembly. Truss vertical and horizontal truss diagonals in particular and any other assembly members shall be appropriately sized for these loads.
 - Uprights, foundations, and trusses that support overhead mounted signs shall be designed for the proposed sign wind area and future wind areas. The design shall consider the effect of torsion induced by the eccentric force location of the center of wind force above (or below) the center of the supporting truss. Truss vertical and horizontal truss diagonals in particular and any other assembly members shall be appropriately sized for these loads.

Fabricate all overhead sign assemblies, including but not limited to foundations, in accordance with the details shown on the approved shop drawings and with the requirements of these Specifications.

Fabricate the span and cantilever supporting structures using tubular members of either aluminum or steel, using only one type of material throughout the project. Sign support structures that are to be attached to bridges shall be fabricated using other structural shapes.

Horizontal components of the supporting structures for overhead signs may be of a truss design or a design using singular (monotube) horizontal members to support the sign

panels. Provide permanent camber in addition to dead load camber in accordance with the *Standard Specifications for Structural Supports for Highway Signs, Luminaires, and Traffic Signals*. Indicate on the shop drawings the amount of camber provided and the method employed in the fabrication of the support to obtain the camber.

Use cantilever sign structures that meet the following design criteria:

- a. Do not exceed an $L / 150$ vertical dead load deflection at the end of the arm due to distortions in the arm and vertical support, where L is the length of the arm from the center of the vertical support to the outer edge of the sign.
- b. Do not exceed an $L / 40$ horizontal deflection at the end of the arm due to distortions in the arm and vertical support, as a result of design wind load.

Attach the overhead sign assemblies to concrete foundations by the use of galvanized anchor bolts with galvanized nuts, flat washers, and lock washers. For cantilever structure use a minimum of eight anchor bolts. Provide anchor bolts that have an anchor plate with nut at the end to be embedded in concrete.

Fabricate attachment assemblies for mounting signs in a manner that allows easy removal of sign panels for repair. Provide adequate supporting frames for mounting the lighting luminaires in the positions shown in the plans or approved shop drawings for all overhead sign assemblies to be illuminated.

Anchor Rod Assembly

Attach the overhead sign structure to concrete foundations by the use of straight galvanized anchor bolts with galvanized heavy hex nuts and flat washers. The rods and nuts shall be galvanized in accordance with AASHTO M232. The washers shall be galvanized in accordance with AASHTO M298 Class C. For cantilever structures, use a minimum of eight anchor rods. Provide anchor rods that have an anchor plate with nut at the end to be embedded in concrete.

Ensure material used in steel anchor rods conforms to AASHTO M 314 or ASTM F1554, and the specified yield strength does not exceed 55,000 psi. Compute the required projection of the anchor rod above the foundation top. Compute the total projection based on the following:

- Provide between 3 and 5 threads of anchor rod projection above the top nut after tightening is complete. Avoid any additional projection, or a normal depth socket torque wrench shall not be used on top nuts.
- Include the sum of the thickness of top nut, top nut flat washer or top nut beveled washers, base plate, leveling nut flat washer or leveling nut beveled washers, leveling nut.
- Set the maximum distance between the bottom of the leveling nut and the foundation top to one nut height to avoid excessive bending stresses in the anchor rod under service conditions.
- Do not use lock washers.

Anchor Rod Nut Tightening Requirements

Prior to installation:

1. Protect the anchor rod threads from damage prior to and during installation.
2. Prior to installation of the rods in the foundation, turn nuts onto and off the rods, well past the elevation of the bottom of the leveling nuts. Turn by the effort of one worker using an ordinary wrench without a cheater bar. Report to the Engineer thread damage requiring unusually large effort.

During installation:

1. Place leveling nuts (bottom nuts) on the anchor rod.
2. Place leveling nut washers on top of the anchor rod leveling nuts.
3. Place a rigid template on top of the leveling nuts to check the level of the nuts. If the anchor nut and washer cannot be brought into firm contact with the template, then beveled washers shall be used.
4. Verify that the distance between the bottom of the leveling nut and the top of the concrete foundation is no more than one anchor rod diameter. If an upright is required to be back-raked, then the distance between the bottom of the leveling nut and the top of the concrete foundation shall be no more than one anchor rod diameter, averaged over the anchor rod group.
5. Place the base plate and structural element to which it is attached. However, do not attach to the upright element, during tightening of the anchor nuts, cantilever beams or arms with span in excess of 10 feet. Luminaire arms and fixtures may be attached prior to standing the pole on the foundation.
6. Place top nut washers.
7. Do not use lock washers.
8. Lubricate threads and bearing surfaces of top nuts. Lubricant shall be beeswax, stick paraffin, or other lubricant approved by the Engineer.
9. Place top nuts. If the anchor nut and washer cannot be brought into firm contact with the base plate, then beveled washers shall be used.
10. Tighten top nuts to snug-tight. A snug-tight condition is defined as the washer and nut being in full contact with the base plate, and the application of the full effort of a workman on a 12-inch wrench. Turn top nuts in increments following a star pattern (using at least two full tightening cycles).

11. To ensure proper pretensioning, after all top nuts have been brought to snug-tight condition, repeat the procedure on the leveling nuts. Turn leveling nuts in increments following a star pattern (using at least two full tightening cycles).
12. At this point, verify if beveled washers are required. Beveled washers shall be required under the leveling nut or top nut if any face of the base plate has a slope greater than 1:20 and / or any nut can not be brought into firm contact with the base plate.
13. Before further nut turning, mark the reference position of the nut in the snug-tight condition with a suitable marking (ink or paint that is not water-soluble). Mark on the corner at the intersection of two flats with a corresponding reference mark on the base plate at each nut. After tightening, verify the nut rotation.
14. Achieve pretensioning by turn-of-nut method. Turn the top nuts to 1/6 of a turn. Do so in a star pattern using at least two full-tightening cycles.
15. After installation, ensure that firm contact exists between the anchor rod nuts, washers, and base plate on any anchor rod installed.
16. For overhead sign assemblies: The span type truss or the cantilever truss may be placed on the uprights or attached to the upright at this time. For signal support structures: The span wires or mast arms may be attached to the upright at this time.
17. After a period of no less than 4 days, and no more than 2 weeks, and in the presence of the Engineer, use a torque wrench to verify that a torque at least equal to 600 foot-pounds is provided on each top nut. For cantilever structures, verify the torque after erection of the remainder of the structure and any heavy attachments to the structure.
18. If any top nut torque reveals less than 600 foot-pounds of effort is required to move the nut, then tighten the nut to no less than 600 foot-pounds.
19. The Design-Build Team shall calibrate the torque indicator, and obtain corresponding certification, for all torque wrenches used for anchor nut tightening. The calibration and certification shall have occurred no more than 12 months prior to use of the torque wrench. Torque wrenches that were calibrated and certified more than twelve months prior to anchor nut tightening shall be re-calibrated and re-certified prior to use. Provide the Engineer a certification of such calibration.
20. Because inspection or re-tightening of the leveling nuts would be prevented, and to reduce moisture retention and associated corrosion, grout shall not be allowed under the base plate.

OVERHEAD SIGN FOUNDATIONS

(05-14-09)

DB11 R013

Description

The work covered by this project special provision consists of the design and construction of overhead sign foundations in accordance with the submitted approved plans and this provision. Design and construct either spread footing type foundations and / or drilled pier type foundations for each overhead sign unless otherwise directed by the Engineer.

Materials

Portland Cement Concrete Production and Delivery.....Section 1000
Reinforcing SteelSection 1070
Anchor BoltsArticle 1072-6
Structural Steel and Overhead Sign StructuresSection 1072 and 1096

Construction Methods

A) General

A North Carolina Licensed Professional Engineer shall seal all design calculations, drawings and recommendations. Design foundations for the effects of dead, wind and ice loads in accordance with the wind zone load shown on the plans and Section 3 of the *AASHTO Standard Specifications for Structural Supports for Highway Signs, Luminaries and Traffic Signals* (including interims). Use either spread footing or drilled pier foundations. In some instances, conflicts with drainage structures may dictate a certain type of foundation. Spread footings or dual drilled pier foundations shall be required for full span overhead signs (no single drilled pier foundations). When designing dual drilled pier foundations, a rectangular grade beam with a moment of inertia approximately equal to either of the drilled piers shall be required to connect the pier tops.

Provide reinforced concrete design in accordance with either Section 13.7.2 or 13.6.2 (whichever is applicable), allowable stress design method, of the *AASHTO Standard Specifications for Structural Supports for Highway Signs, Luminaries and Traffic Signals* (including interims).

Consider sloping ground in the design, if applicable. Do not exceed an allowable bearing pressure of 3 ksf for spread footings. For drilled pier foundations, do not exceed an allowable lateral soil pressure of 4 ksf for AASHTO Group II Loading. Use the following default soil parameters and groundwater elevation for foundation design in the absence of a site-specific subsurface investigation in accordance with this project special provision.

Total Unit Weight = 120 pcf

Friction Angle = 30 degrees

Cohesion = 0 psf

Assume the groundwater elevation is at a depth of 7 feet below the ground surface. If the groundwater is encountered at a depth shallower than 7 feet, the overhead sign foundation shall be redesigned based upon the actual field conditions. The default soil parameters and allowable pressures shall not apply to very soft or loose soil, muck (generally, SPT blow counts per foot less than 4), weathered rock or hard rock (generally, SPT refusal). If soft or loose soil, muck, weathered rock or hard rock conditions are present, a site-specific subsurface investigation and foundation design shall be required in accordance with this project special provision.

Design spread footings in accordance with Sections 4.4.1 through 4.4.10, allowable stress design method, of the *AASHTO Standard Specifications for Highway Bridges* (including interims). Restrict uplift due to the eccentricity of the loading to one corner of the footing and the tension area shall not exceed 25% of the total bearing area of the spread footing.

Design drilled piers in accordance with Sections 4.6.1 through 4.6.5, allowable stress design method, of the *AASHTO Standard Specifications for Highway Bridges* (including interims). If drilled piers are designed for skin friction only, increase the required length of each drilled pier a minimum of 6 inches to allow for sediment. If drilled piers are designed for end bearing, no additional length is required; however, the drilled piers shall be subject to the cleanliness requirements in Bottom Cleanliness under “Drilled Pier Construction:” below. Clearly state on the plans whether end bearing was accounted for in the foundation design.

Calculate expected vertical, lateral and torsional movements for single drilled pier foundations. Provide drilled pier foundations that result in a horizontal lateral movement of less than 1 inch at the top of the pier and a horizontal rotational movement of less than 1 inch at the edge of the pier. Also, use a factor of safety of 2.0 for lateral and torsion failure. Preliminary design methods described in Section 13.6.1.1 of the *AASHTO Standard Specifications for Structural Supports for Highway Signs, Luminaries and Traffic Signals* (including interims) shall be used to incorporate a factor of safety in foundation design for lateral failure. Wings shall be required to increase torsion resistance for cantilever signs supported by a single drilled pier.

If a site-specific subsurface investigation is performed, use only an NCDOT Highway Design Branch Pre-Qualified Geotechnical Engineering Firm to provide a site specific foundation design.

B) Subsurface Investigation

The Design-Build Team may elect to conduct a site specific subsurface investigation at each proposed overhead sign foundation location in lieu of using the default soil parameters and allowable pressures referenced above. In this case, and subject to the requirements below, perform a boring at each overhead sign foundation location and provide boring data on an NCDOT Standard Boring Log form. Download this form from the NCDOT site at

<http://www.ncdot.org/doh/preconstruct/highway/geotech/contractserv/investigation/Documents/BoringLogs.zip>.

A licensed geologist or a professional engineer registered in the State of North Carolina and employed by an NCDOT Highway Design Branch pre-qualified Geotechnical Engineering Firm shall seal each boring log. Use only an NCDOT Highway Design Branch pre-qualified Geotechnical Engineering Firm to conduct the subsurface investigation. Perform the investigation only after rough grade (within 3 feet of final grade) is achieved. Locate each boring within 3 feet of the center of the overhead sign foundation. Drill the boring to a minimum depth of 10 feet below the required spread footing bearing or drilled pier tip elevation, whichever is deeper. Conduct Standard Penetrating Tests at 1 foot, 2.5 feet, 5 feet, 7.5 feet, 10 feet and every 5 feet after 10 feet below the rough grade in accordance with ASTM D-1586. A boring may be terminated above the minimum depth required (10 feet below the foundation elevation) if one of the following conditions occur: (a) a total of 100 blows have been applied in any 2 consecutive 6-inch intervals; (b) a total of 50 blows have been applied with less than 3 inches of penetration.

C) Foundation Construction

Excavate footings for overhead sign structures in accordance with the applicable provisions of Section 410 of the 2006 *Standard Specifications for Roads and Structures*. Construct footings for overhead sign structures in accordance with Section 825 of the 2006 *Standard Specifications for Roads and Structures*. Construct all footings with Class A concrete. Where rectangular forms are used, use forms that have a chamfer strip at all corners for at least that distance protruding above finished ground. Use chamfers, which measure one-inch along the diagonal face.

Securely brace anchor bolts positioned in the form and hold in proper position and alignment. Provide a rubbed finish on concrete surfaces to be exposed above finished ground in accordance with Section 825-6 (D) of the 2006 *Standard Specifications for Roads and Structures*. Do not erect overhead sign structures on foundations until the concrete has reached a minimum compressive strength of 3000 psi. Determine concrete compressive strength by nondestructive test methods or compressive strength tests made in accordance with AASHTO T22 and T23. Furnish equipment used for nondestructive tests and obtain Engineer's approval prior to performing the tests.

D) Drilled Pier Construction

Excavation

Perform excavations for drilled piers to the required dimensions and lengths including all miscellaneous grading and excavation necessary to install the drilled pier. Depending on the subsurface conditions encountered excavation in hard rock, weathered rock or removal of boulders and debris may be required.

Dispose of drilling spoils as directed by the Engineer and in accordance with Section 802 of the 2006 *Standard Specifications for Roads and Structures*. Drilling spoils consist of all material excavated including water or slurry removed from the excavation either by pumping or with augers.

Construct drilled piers within the tolerances specified herein. If tolerances are exceeded, provide additional construction as approved by the Engineer to bring the piers within the tolerances specified. Construct drilled piers such that the axis at the top of the piers is no more than 3 inches in any direction from the specified position. Build drilled piers within 1% of the plumb deviation for the total length of the piers. When a grade beam is not required at the top of a pier, locate the top of pier elevation between 18 inches above and 6 inches above the finished grade elevation. Form the top of the pier such that the concrete is smooth and level.

If unstable, caving or sloughing soils are anticipated or encountered, stabilize drilled pier excavations with steel casing and / or polymer slurry. Steel casing may be either the sectional type or one continuous corrugated or non-corrugated piece. All steel casings shall consist of clean watertight steel of ample strength to withstand handling and driving stresses and the pressures imposed by concrete, earth or backfill. Use steel casings with an outside diameter equal to the specified pier size and a minimum wall thickness of 1/4 inch. Extract all temporary casings during concrete placement in accordance with this project special provision unless the Design-Build Team chooses to leave the casing in place in accordance with the requirements below.

Any steel casing left in place will be considered permanent casing. When installing permanent casing do not drill or excavate below the tip of the permanent casing at any time such that the permanent casing is against undisturbed soil. The Design-Build Team may excavate a hole with a minimum diameter of 12 inches smaller than the specified size of the pier in order to facilitate permanent casing installation provided the sides of the excavation do not slough during drilling such that the hole diameter becomes larger than the inside diameter of the casing. Permanent steel casings shall only be allowed for full span overhead signs as approved by the Engineer and prohibited for cantilever overhead signs. No additional compensation will be paid for permanent casing.

If the Design-Build Team elects to use polymer slurry to stabilize the excavation, use one of the polymers listed in the table below:

PRODUCT	MANUFACTURER
SlurryPro EXL	KB Technologies Ltd 3648 FM 1960 West Suite 107 Houston, TX 77068 (800) 525-5237
Super Mud	PDS Company 105 West Sharp Street El Dorado, AR 71730 (800) 243-7455
Shore Pac GCV	CETCO Drilling Products Group 1500 West Shure Drive Arlington Heights, IL 60004 (800) 527-9948

Use slurry in accordance with the manufacturer's guidelines and recommendations unless approved otherwise by the Engineer. The Design-Build Team should be aware that polymer slurry might not be appropriate for a given site. Polymer slurry shall not be used for excavations in very soft or loose soils. If the excavation can not be stabilized with polymer slurry, the Engineer may require a site-specific subsurface investigation (if not done during design) and the use of steel casing. No additional time or compensation will be provided if steel casing and / or polymer slurry are required to stabilize the excavation.

Construct all drilled piers such that the piers are cast against undisturbed soil. If a larger casing and drilled pier are required as a result of unstable or caving material during drilling, backfill the excavation before removing the casing to be replaced. No additional time or compensation will be provided for substituting a larger diameter drilled pier in order to construct a drilled pier cast against undisturbed soil.

Any temporary steel casing that becomes bound or fouled during pier construction and cannot be practically removed may constitute a defect in the drilled pier. Improve such defective piers to the satisfaction of the Engineer by removing the concrete and enlarging the drilled pier, providing a replacement pier or other approved means. All corrective measures including redesign as a result of defective piers shall not be cause for any claims or requests for additional time or compensation.

Bottom Cleanliness

If the plans indicate end bearing was used in the design, after a drilled pier excavation is complete, and immediately before concrete placement, demonstrate acceptable bottom cleanliness of the drilled pier excavation to the Engineer for approval. Provide any equipment, personnel and assistance required for the

Engineer to inspect the drilled pier excavation. The pier excavation bottom shall be considered clean if no portion of the bottom area has more than 3 inches of sediment as determined by the Engineer.

Reinforcing Steel

Completely assemble a cage of reinforcing steel consisting of longitudinal and spiral bars and place cage in the drilled pier excavation as a unit immediately upon completion of drilling unless the excavation is entirely cased. If the drilled pier excavation is entirely cased down to the tip, immediate placement of the reinforcing steel and the concrete is not required.

Lift the cage so racking and cage distortion does not occur. Keep the cage plumb during concrete placement operations and casing extraction. Check the position of the cage before and after placing the concrete.

Securely crosstie the vertical and spiral reinforcement at each intersection with double wire. Support or hold down the cage so that the vertical displacement during concrete placement and casing extraction does not exceed 2 inches.

Do not set the cage on the bottom of the drilled pier excavation. Place plastic bolsters under each vertical reinforcing bar that are tall enough to raise the rebar cage off the bottom of the drilled pier excavation a minimum of 3 inches.

In order to ensure a minimum of 3 inches of concrete cover and achieve concentric spacing of the cage within the pier, tie plastic spacer wheels at five points around the cage perimeter. Use spacer wheels that provide a minimum of 3 inches "blocking" from the outside face of the spiral bars to the outermost surface of the drilled pier. Tie spacer wheels that snap together with wire and allow them to rotate. Use spacer wheels that span at least two adjacent vertical bars. Start placing spacer wheels at the bottom of the cage and continue up along its length at maximum 10-foot intervals. Supply additional peripheral spacer wheels at closer intervals as necessary or as directed by the Engineer.

Concrete

Begin concrete placement immediately after inserting reinforcing steel into the drilled pier excavation.

1) Concrete Mix

Provide the mix design for drilled pier concrete for approval and, except as modified herein, meeting the requirements of Section 1000 of the 2006 *Standard Specifications for Roads and Structures*.

Designate the concrete as Drilled Pier Concrete with a minimum compressive strength of 4500 psi at 28 days. The Design-Build Team may use a high early

strength mix design as approved by the Engineer. Make certain the cementitious material content complies with one of the following options:

- Provide a minimum cement content of 640 lbs / yd³ and a maximum cement content of 800 lbs / yd³; however, if the alkali content of the cement exceeds 0.4%, reduce the cement content by 20% and replace it with fly ash at the rate of 1.2 LB of fly ash per LB of cement removed.
- If Type IP blended cement is used, use a minimum of 665 lbs / yd³ Type IP blended cement and a maximum of 833 lbs / yd³ Type IP blended cement in the mix.

Limit the water-cementitious material ratio to a maximum of 0.45. Do not air-entrain drilled pier concrete.

Produce a workable mix so that vibrating or prodding is not required to consolidate the concrete. When placing the concrete, make certain the slump is between 5 and 7 inches for dry placement of concrete or 7 and 9 inches for wet placement of concrete.

Use Type I or Type II cement or Type IP blended cement and either No. 67 or No. 78M coarse aggregate in the mix. Use an NCDOT approved water-reducer, water-reducing retarder, high-range water-reducer or high-range water-reducing retarder to facilitate placement of the concrete, if necessary. Do not use a stabilizing admixture as a retarder in Drilled Pier Concrete without prior approval of the Engineer. Use admixtures that satisfy AASHTO M194 and add admixtures at the concrete plant when the mixing water is introduced into the concrete. Redosing of admixtures shall not be permitted.

Place the concrete within 2 hours after introducing the mixing water. Ensure that the concrete temperature at the time of placement is 90°F or less.

2) Concrete Placement

Place concrete such that the drilled pier is a monolithic structure. Temporary casing may be completely removed and concrete placement may be temporarily suspended when the concrete level is within 42 to 48 inches of the ground elevation to allow for placement of anchor bolts and construction of grade beam or wings. Do not pause concrete placement if unstable casing soils are present at the ground surface. Remove any water or slurry above the concrete and clean the concrete surface of all scum and sediment to expose clean, uncontaminated concrete before inserting the anchor bolts and conduit. Resume concrete pouring within 2 hours.

Do not dewater any drilled pier excavations unless the Engineer approves the dewatering and the excavation is entirely cased down to tip. Do not begin to remove the temporary casing until the level of concrete within the casing is in

excess of 10 feet above the bottom of the casing being removed. Maintain the concrete level at least 10 feet above the bottom of casing throughout the entire casing extraction operation except when concrete is near the top of the drilled pier elevation. Maintain a sufficient head of concrete above the bottom of casing to overcome outside soil and water pressure. As the temporary casing is withdrawn, exercise care in maintaining an adequate level of concrete within the casing so that fluid trapped behind the casing is displaced upward and discharged at the ground surface without contaminating or displacing the drilled pier concrete. Exerting downward pressure, hammering or vibrating the temporary casing is permitted to facilitate extraction.

Keep a record of the volume of concrete placed in each drilled pier excavation and make it available to the Engineer.

After all the pumps have been removed from the excavation, the water inflow rate determines the concrete placement procedure. If the inflow rate is less than 6 inches per half-hour, the concrete placement shall be considered dry. If the water inflow rate is greater than 6 inches per half-hour, the concrete placement shall be considered wet.

- **Dry Placement:** Before placing concrete, make certain the drilled pier excavation is dry so the flow of concrete completely around the reinforcing steel can be certified by visual inspection. Place the concrete by free fall with a central drop method where the concrete is chuted directly down the center of the excavation.
- **Wet Placement:** Maintain a static water or slurry level in the excavation before placing concrete. Place concrete with a tremie or a pump in accordance with the applicable parts of Sections 420-4 and 420-5 of the 2006 *Standard Specifications for Roads and Structures*. Use a tremie tube or pump pipe made of steel with watertight joints. Passing concrete through a hopper at the tube end or through side openings as the tremie is retrieved during concrete placement is permitted. Use a discharge control to prevent concrete contamination when the tremie tube or pump pipe is initially placed in the excavation. Extend the tremie tube or pump pipe into the concrete a minimum of 5 feet at all times except when the concrete is initially introduced into the pier excavation. If the tremie tube or pump pipe pulls out of the concrete for any reason after the initial concrete is placed, restart concrete placement with a steel capped tremie tube or pump pipe.

Once the concrete in the excavation reaches the same elevation as the static water level, placing concrete with the dry method is permitted. Before changing to the dry method of concrete placement, remove any water or slurry above the concrete and clean the concrete surface of all scum and sediment to expose clean, uncontaminated concrete.

Vibration shall only be permitted, if needed, in the top 10 feet of the drilled pier or as approved by the Engineer. Remove any contaminated concrete from the top of the drilled pier and wasted concrete from the area surrounding the drilled pier upon completion.

3) Concrete Placement Time

Place concrete within the time frames specified in Table 1000-2 of the 2006 *Standard Specifications for Roads and Structures* for Class AA concrete except as noted herein. Do not place concrete so fast as to trap air, water, fluids, soil or any other deleterious materials in the vicinity of the reinforcing steel and the annular zone between the rebar cage and the excavation walls. Should a delay occur because of concrete delivery or other factors reduce the placement rate to maintain some movement of the concrete. No more than 45 minutes shall be allowed between placements.

E) Scheduling and Restrictions

If caving or sloughing occurs, no additional compensation will be provided for additional concrete to fill the resulting voids.

During the first 16 hours after a drilled pier has achieved its initial concrete set as determined by the Engineer, do not drill adjacent piers, do not install adjacent piles and do not allow any heavy construction equipment loads or “excessive” vibrations to occur at any point within a 20 foot radius of the drilled pier.

In the event that the procedures described herein are performed unsatisfactorily, the Engineer reserves the right to shut down the construction operations or reject the drilled piers. If the integrity of a drilled pier is in question, use core drilling, sonic or other NCDOT approved methods at no additional cost to the Department and under the direction of the Engineer. Dewater and backfill core drill holes with an approved high strength grout with a minimum compressive strength of 4500 psi. Propose remedial measures for any defective drilled piers and obtain approval of all proposals from the Engineer before implementation. No additional time or compensation will be provided for losses or damage due to remedial work or any investigation of drilled piers found defective or not in accordance with this project special provision or the plans.

SAFETY FENCE:

Description

Safety Fence shall consist of furnishing materials, installing and maintaining polyethylene or polypropylene fence along the outside riparian buffer, wetland, or water boundary, or other boundaries located within the construction corridor to mark the areas that have been approved to infringe within the buffer, wetland, endangered vegetations, culturally sensitive areas or water. The fence shall be installed prior to any land disturbing activities.

Interior boundaries for jurisdictional areas noted above shall be delineated by stakes and highly visible flagging.

Jurisdictional boundaries at staging areas, waste sites, or borrow pits, whether considered outside or interior boundaries shall be delineated by stakes and highly visible flagging.

Materials

(A) Safety Fencing

Polyethylene or polypropylene fence shall be a highly visible preconstructed safety fence approved by the Engineer. The fence material shall have an ultraviolet coating.

Either wood posts or steel posts may be used. Wood posts shall be hardwood with a wedge or pencil tip at one end, and shall be at least 5 ft. in length with a minimum nominal 2" x 2" cross section. Steel posts shall be at least 5 ft. in length, and have a minimum weight of 0.85 lb/ft of length.

(B) Boundary Flagging

Wooden stakes shall be 4 feet in length with a minimum nominal 3/4"x 1-3/4" cross section. The flagging shall be at least 1" in width. The flagging material shall be vinyl and shall be orange in color and highly visible.

Construction Methods

No additional clearing and grubbing is anticipated for the installation of this fence. The fence shall be erected to conform to the general contour of the ground.

(A) Safety Fencing

Posts shall be set at a maximum spacing of 10 ft., maintained in a vertical position and hand set or set with a post driver. If hand set, all backfill material shall be thoroughly tamped. Wood posts may be sharpened to a dull point if power driven. Posts damaged by power driving shall be removed and replaced prior to final acceptance. The tops of all wood posts shall be cut at a 30-degree angle. The wood posts may, at the option of the Contractor, be cut at this angle either before or after the posts are erected.

The fence fabric shall be attached to the wood posts with one 2" galvanized wire staple across each cable or to the steel posts with wire or other acceptable means.

Place construction stakes to establish the location of the safety fence in accordance with Article 105-9 or Article 801-1 of the *Standard Specifications*. No direct pay will be made for the staking of the safety fence. All stakeouts shall be considered incidental to *Construction Surveying*.

The Contractor shall be required to maintain the safety fence in a satisfactory condition for the duration of the project as determined by the Engineer.

(B) Boundary Flagging

Installation for delineation of interior boundaries shall consist of wooden stakes on 25 feet maximum intervals with highly visible orange flagging attached. Stakes shall be installed a minimum of 6” into the ground. Interior boundaries may be staked on a tangent that runs parallel to buffer but must not encroach on the buffer at any location. Interior boundaries of hand clearing shall be identified with a different colored flagging to distinguish it from mechanized clearing.

Installation for delineation of interior boundaries will be placed in accordance with Article 105-9 or Article 801-1 of the *Standard Specifications*. No direct pay will be made for delineation of the interior boundaries. All delineation shall be considered incidental to *Construction Surveying*.

Installation for delineation of all jurisdictional boundaries at staging areas, waste sites, or borrow pits shall consist of wooden stakes on 25 feet maximum intervals with highly visible orange flagging attached. Stakes shall be installed a minimum of 6” into the ground. Additional flagging may be placed on overhanging vegetation to enhance visibility but does not substitute for installation of stakes.

Installation for delineation of all jurisdictional boundaries at staging areas, waste sites, or borrow pits shall be performed in accordance with Subarticle 230-4(B)(3)(d) or Subarticle 802-2(F) of the *Standard Specifications*. No direct pay will be made for delineation of any jurisdictional boundaries at staging areas, waste sites, or borrow pits. All delineation shall be considered incidental to *Borrow Material* or *Disposal of Waste and Debris*.

The Contractor shall be required to maintain alternative stakes and highly visible flagging in a satisfactory condition for the duration of the project as determined by the Engineer.

EPOXY PAVEMENT MARKING MATERIAL

(01-15-08)

SP

Description

This work shall consist of applying black epoxy pavement marking material on concrete or asphalt pavements.

Materials

Epoxy Pavement Marking Material shall conform to the requirements of Section 1087 of the *2006 Standard Specifications for Roads and Structures* and the following:

Epoxy Composition

Epoxy pavement marking shall conform to the following materials:

Component	<u>By Weight</u>
Binder - Epoxy Resin	77% Max.
Titanium Dioxide (ASTM D-476-73 Type II & III)	18% Min.
Chrome Yellow (for yellow markings) (ASTM D-211 Type III)	23% Min.

The epoxy resin proportion of component A white, and component A yellow shall be identical, if the same component B is used for both white and yellow.

Combine the two components of the resin in the manner and proportions as recommended by the manufacturer based on tested pavement marking performance.

Epoxy Pavement Marking Material

(A) Formulation

Use epoxy pavement marking material consisting of 100% solid two-part system formulated and designed to provide a simple volumetric mixing ratio of the two components.

(B) Epoxide Value: ASTM D1652

WPE of the epoxy resin shall be 250 ± 50 for both white and yellow component A on a pigment free basis.

(C) Amine Value ASTM D2074

The total amine value of the curing agent (component B) shall be 450 ± 50

(D) Requirements

(1) Color

Black: Must meet ASTM standard

(2) Hardness: ASTM D2240

Minimum Shore D hardness: 80

(3) Abrasion Resistance: ASTM C-501

Minimum wear index of catalyzed sample: 80

(4) Adhesion to Concrete: ASTM D4541

At 100% concrete failure: greater than 325 psi

(5) Tensile Strength: ASTM D638

- Minimum average tensile strength: 6000 psi
- (6) Compressive Strength: ASTM D695
- Minimum compressive strength: 12000 psi
- (7) Drying Time: ASTM D711
- Maximum drying time at 75±2°F: 10 minutes
- (8) Gel Time: ASTM D2471
- Maximum gel time: 3 minutes

(E) Material Certification: Type 3 Material Certification and Type 4 Material Certification

Construction Methods

Epoxy Pavement Marking Material shall conform to the requirements of Section 1205 of the *2006 Standard Specifications for Roads and Structures*.

(A) Application Equipment

Use epoxy application equipment, which is equipped with or capable of the following:

Precisely metering the two components in the ratio of proportion recommended by the manufacturer.

Producing the required amount of heat at the mixing head and gun tip.

Maintaining temperatures within the tolerances recommended.

Gauges for each proportioning pump so that any pressure difference can be easily monitored.

A minimum 24" long static mixer unit for proper mixing of the two components of the epoxy marking material.

Each component of the epoxy pavement marking shall be in a homogeneous state prior to mixing,

Have the capability to totally mix component A with component B immediately prior to the marking application.

Have the capability to spray both yellow and white pavement marking material and have the equipment mounted on a truck of sufficient size and stability with an adequate power source to produce uniform lines of the specified dimension.

A metering device to register the accumulated installed footage for each gun

(B) Weather Limitations

Apply epoxy pavement marking only when the ambient air temperature and the pavement surface temperature is a minimum of 35°F and rising.

(C) Application

Produce epoxy pavement marking lines that have a minimum dry thickness of 15 mils when placed on concrete pavements and 20 mils when placed on asphalt pavements.

Use **Type I** epoxy material (fast dry) for epoxy pavement markings except when otherwise specified in the contract documents.

Type II epoxy material may be used with lane closures as approved by the Engineer to allow for curing time.

Do not place epoxy markings on fresh asphalt pavements until 15 days have elapsed after the last asphalt layer is placed.

Using the epoxy application equipment, apply the pavement marking materials simultaneously. Hot-spray the epoxy resin, mixed in accordance with the manufacturer's recommendations, onto the pavement surface within an application temperature range recommended by the manufacturer. Inject retroreflective glass beads into the molten (liquid) Epoxy Marking.

Individual Components: Before mixing, heat the individual components to within the temperature range of 100°F to 170°F. Do not exceed the upper limit of the manufacturer's recommended heating temperature at any time under any circumstances.

Mixed Material: After mixing, ensure that the application temperatures for the combined materials at the gun tip are within the temperature range recommended by the manufacturer for the particular product used.

Produce marking, which upon cooling, has the ability to resist deformation caused by traffic throughout its entire length.

(D) Observation Period

Epoxy pavement markings will be subject to a 180 day observation period.

Maintain responsibility for the pavement markings for a 180 day observation period beginning upon the satisfactory completion of all work required in the plans. Guarantee the markings under the payment and performance bond in accordance with Article 109-10.

Have traffic operating on the facility during the entire 180 day observation period unless otherwise directed.

Provide pavement marking material, which during the 180 day observation period, shows no signs of failure due to blistering, excessive cracking, chipping, bleeding, staining, discoloration, oil content of the pavement materials, smearing or spreading under heat, deterioration due to contact with grease deposits, oil, diesel fuel, or gasoline drippings, spilling, poor adhesion to the pavement materials, vehicular damage, debonding and normal wear.

Replace, at no additional expense to the Department, any pavement markings that do not perform satisfactorily under traffic during the 180 day observation period.

DYNAMIC MESSAGE SIGN

GENERAL REQUIREMENTS

A) DESCRIPTION

Conform to these Project Special Provisions, the approved Project Plans, and the *2006 Standard Specifications for Roads and Structures* (also referred to hereinafter as the “Standard Specifications”). The current edition of these specifications and publications in effect on the date of advertisement will apply.

B) Scope

The scope of this project includes removing one (1) existing overhead Dynamic Message Sign (DMS) system located on I-85 southbound near MM 86 in Davidson County and replacing the existing DMS with one (1) new pedestal mounted DMS sign system near the same location. Obtain approval from the Regional ITS Engineer on the location of the new DMS. Remove the existing DMS enclosure along with all the DMS enclosure components and deliver them to the Metrolina Regional Transportation Management Center (MRTMC) in Charlotte, NC. Remove and dispose of the existing overhead structure, base mounted cabinet and foundation. Install a new pedestal mounted DMS and a new pole mounted equipment cabinet. Abandon in place the existing conduits, communications and feeder conductors between the DMS and the existing cabinet. Install a new meter base and disconnect combination panel. Install new conduit, communications and feeder conductors from the new electrical service to the new cabinet.

Integrate the new DMS with the MRTMC Traffic Management System (TMS) and conduct device and system tests as described in these Project Special Provisions. The MRTMC is located at 2327 Tipton Drive, Charlotte, NC.

Submit construction plans and special provisions for the new DMS location, DMS line drawings, conduit sizes and routing, electrical service equipment including wire and wires sizes to the Engineer for approval. Construction plans and special provisions shall be sealed by a Professional Engineer registered in the state of North Carolina, and bearing his signature, seal, and date of acceptance.

C) Qualified Products

Furnish new equipment, materials, and hardware unless otherwise required. Inscribe manufacturer's name, model number, serial number, and any additional information needed for proper identification on each piece of equipment housed in a case or housing.

Furnish factory assembled cables without adapters, unless otherwise approved by the Engineer, for all cables required to interconnect any field or central equipment including but not limited to fiber optic transceivers.

Certain equipment listed in these Project Special Provisions must be pre-approved on the Department's ITS & Signals Qualified Products List (QPL) by the date of installation. Equipment, material, and hardware not pre-approved when required will not be allowed for use on the project.

The QPL is available on the Department's website. The QPL website is:

<http://www.ncdot.org/doh/preconstruct/traffic/ITSS/SMS/qpl/>

DISPOSAL OF DMS COMPONENTS**A) DESCRIPTION**

Remove the existing DMS enclosure along with all the DMS enclosure components and deliver them to the MRTMC in Charlotte, NC. Remove and dispose of the one (1) existing DMS structure, two (2) DMS structure foundations, one (1) base mounted DMS cabinet, and one (1) DMS cabinet foundation.

Perform the work required by this section in accordance with Section 907 of the Standard Specifications.

B) REMOVAL AND DISPOSAL OF EXISTING DMS, CABINET AND FOUNDATIONS

At the DMS located on I-85 southbound near MM 86 in Davidson County:

Remove the existing DMS enclosure along with all the DMS enclosure components and deliver them to the MRTMC in Charlotte. Coordinate delivery of the DMS equipment with the Engineer. Dispose of the base mounted cabinet and cabinet foundation. Abandon in place the existing conduits, communications and feeder conductors between the DMS and the base mounted cabinet.

Ensure all abandoned conduits and ground rods are removed to 24-inches below finished grade. Comply with Section 907-2(C) of the Standard Specifications.

C) REMOVAL AND DISPOSAL OF EXISTING DMS STRUCTURE AND STRUCTURE FOUNDATION

Remove and dispose of the existing DMS overhead structure and structure foundations. Remove and dispose of all cables, conduits, and junction boxes attached to the structure. Ensure all abandoned conduits and ground rods are removed to 24-inches below finished grade. Comply with Section 907-2(C) of the Standard Specifications.

D) REMOVAL AND DISPOSAL OF EXISTING ELECTRICAL SERVICE

Remove and dispose of the existing electrical service equipment. Coordinate with the utility company to de-energize the service and remove the meter. Remove and dispose of the existing meter base and service disconnect equipment. Abandon in place feeder conductors and conduits. Comply with Section 907-2(C) of the Standard Specifications.

CONDUIT**A) DESCRIPTION**

Install underground conduit from the new electrical service to the new pedestal mounted DMS. Comply with the Standard Specifications Section 1715 for "Underground Conduit."

B) MATERIAL

Furnish underground PVC conduits. All vertical conduits (entrance to electrical service and equipment disconnect and pole mounted cabinet) must be rigid galvanized steel.

C) CONSTRUCTION METHODS

Use adapters and rigid galvanized steel sweeping elbows to transition from PVC conduit to rigid galvanized steel conduit.

ELECTRICAL SERVICE**A) DESCRIPTION**

Install new electrical service equipment. Comply with the National Electrical Code (NEC), the National Electrical Safety Code (NESC), the Standard Specifications, the Project Special Provisions, and all local ordinances. All work involving electrical service shall be coordinated with the appropriate utility company and the Metrolina Regional ITS Engineer or his designated representative at (704) 347-6601.

B) MATERIAL**1. Meter Base/Disconnect Combination Panel**

Furnish and install a new meter base/disconnect combination panel for electrical service to the new pedestal mounted DMS. Provide meter base/disconnect panels that have a minimum of four (4) spaces in the disconnect. Furnish double pole 50A circuit breakers. Furnish each with a minimum of 10,000 RMS symmetrical amperes short circuit current rating in a lockable NEMA 3R enclosure. Ensure meter base/disconnect combination panel is listed as meeting UL Standard UL-67 and marked as being suitable for use as service equipment. Fabricate enclosure from galvanized steel and electrostatically apply dry powder paint finish, light gray in color, to yield a minimum thickness of 2.4 mils. All exterior surfaces must be powder coated steel. Provide ground bus and neutral bus with a minimum of four terminals and a minimum wire capacity range of number 8 through number 3/0 AWG.

Furnish NEMA Type 3R combinational panel rated 200 Ampere minimum that meets the requirements of the local utility. Provide meter base with sockets' ampere rating based on sockets being wired with a minimum of 167 degrees F insulated wire.

Furnish 4 terminal, 600 volt, single phase, 3-wire meter bases that comply with the following:

- Line, Load, and Neutral Terminals accept 4/0 AWG and smaller Copper/Aluminum wire
- With or without horn bypass
- Made of galvanized steel
- Listed as meeting UL Standard US-414
- Overhead or underground service entrance specified.

2. Equipment Cabinet Disconnect

Furnish and install a new equipment cabinet disconnect if the main service disconnect is greater than 50 feet from the DMS equipment cabinet, if is not easily accessible or if the existing equipment cabinet disconnect is rusted or damaged. Furnish double pole 50A circuit breakers with a minimum of 10,000 RMS symmetrical amperes short circuit current rating in a lockable NEMA 3R enclosure. Ensure equipment cabinet disconnect is listed as meeting UL Standard UL-489. Fabricate enclosure from galvanized steel and electrostatically apply dry powder pain finish, light gray in color, to yield a minimum thickness of 2.4 mils. All exterior surfaces must be powder coated steel. Provide ground bus and neutral bus with a minimum of four terminals and a minimum wire capacity range of number 8 through number 2/0 AWG.

3. Wire Copper Service Entrance Conductors

If a new aerial electrical service is to be installed, furnish 3-wire stranded copper service entrance conductors with THWN rating. Provide conductors with black, red, and white insulation that are intended for power circuits at 600 Volts or less and comply with the following:

- Listed as meeting UL Standard UL-83
- Meets ASTM B-3 and B-8 or B-787 standards.

The Contractor is responsible for ensuring the wire sizes are adequate for providing electrical service to the new pedestal mounted DMS.

4. Wire Copper Feeder Conductors

Furnish 4-wire stranded copper feeder conductors with THWN rating for supplying power to DMS field equipment cabinets. Provide conductors with black, red, white, and green insulation that are intended for power circuits at 600 Volts or less and comply with the following:

- Listed as meeting UL Standard UL-83
- Meets ASTM B-3 and B-8 or B-787 standards.

The Contractor is responsible for ensuring the wire sizes are adequate for providing electrical service to the new pedestal mounted DMS.

5. Riser with Weatherhead

If necessary, furnish 1.5" rigid galvanized risers with clamp on aluminum weatherhead for the installation of new electrical service. Comply with section 1722 of the Standard Specifications.

6. Grounding System

For aerial service drop, furnish 5/8"x10' copper clad steel grounding electrodes (ground rods), #4 AWG solid bare copper conductors, and exothermic welding kits for grounding system installations. Comply with the NEC, Standard Specifications, and this Project Special Provisions.

C) CONSTRUCTION METHODS

Permanently label cables at all access points using nylon tags labeled with permanent ink. Ensure each cable has a unique identifier. Label cables immediately upon installation. Use component name and labeling scheme approved by the Engineer.

1. Meter Base/Disconnect Combination Panel

Install a meter base/disconnect combination panel including riser assemblies and service entrance conductors. Route the feeder conductors from the meter base/disconnect to the DMS equipment cabinet in conduit. Provide rigid galvanized conduit for above ground and PVC for below ground installations.

2. Equipment Cabinet Disconnect

Install an equipment cabinet disconnect. Install double pole 50A circuit breakers. Install 4-wire THWN stranded copper feeder conductors between the new service disconnect and the equipment cabinet disconnect. Route the conductors from the equipment cabinet disconnect to the DMS cabinet in rigid galvanized steel conduit. Bond the equipment cabinet disconnect in accordance with the NEC. Ensure that the grounding system complies with the grounding requirements of these Project Special Provisions and the Standard Specifications.

3. Wire Copper Service Entrance Conductors

Furnish and install 3-wire THWN stranded copper service entrance conductors in 1.5" rigid galvanized riser to provide electrical service for the DMS installation. Install a waterproof hub on top of the meter-base for riser entrance/exit. It is the Contractor's responsibility to size the conductors appropriately. Comply with the Standard Specifications, Standard Drawings and all applicable electrical codes.

4. Wire Copper Feeder Conductors

Install 4-wire THWN stranded copper feeder conductors in new underground conduit to supply 240/120 VAC to the DMS field equipment cabinet. It is the Contractor's responsibility to size the conductors and conduit according to NEC requirements. Comply with the Standard Specifications, Standard Drawings and all applicable electrical codes.

5. Riser with Weatherhead

Install 1.5" rigid galvanized riser with clamp on aluminum weatherhead for the installation of new electrical service.

6. Grounding System

Install a minimum of three (3) ground rods spaced a minimum of 10 feet apart. Connect the #4 AWG grounding conductor to ground rods using an exothermic welding process. Test the system to ensure a ground resistance of 20-ohms or less is achieved. Drive additional ground rods as necessary or as directed by the Engineer to achieve the proper ground resistance.

INTEGRATION

A) DESCRIPTION

Center to Field communication will be accomplished over a Public Switched Telephone Network (PSTN). Furnish and install 6-pair 19AWG filled telephone cable (RUS PE-39 compliant) in new conduit sized per the NEC. Modify the control center hardware and existing DMS Control Software at the MRTMC to integrate the new sign.

B) CONSTRUCTION METHOD

Install 6-pair 19AWG filled telephone cable (RUS PE-39 compliant) from the telephone company demarcation point (interface box) to the inside of the new DMS field cabinet. Terminate the new telephone cable to a phone jack and make all necessary connections in the DMS cabinet. It is the Contractor's responsibility for terminating the telephone cable in the existing telephone demarcation box.

At the control center, modify the MRTMC Traffic Management System to integrate the new DMS. Use the DMS Control Software to add and configure the new DMS into the DMS database. Modify the GUI, if necessary, to position DMS icons on the regional map view. Remove the existing signs from the DMS database. Coordinate all integration activities with the MRTMC staff. The contact phone number is: (704) 347-6601.

DYNAMIC MESSAGE SIGN (DMS)

A) DESCRIPTION

DMSs used on the State Highway System shall be preapproved on the current NCDOT ITS & Signals Qualified Products List (QPL) by the date of installation. DMSs not preapproved will not be allowed for use on the project. To ensure compatibility with the existing DMS Control Software deployed in the State, furnish NTCIP compliant DMSs that are fully compatible with Daktronics, Inc. Vanguard software (also referred to hereinafter as the "Control Software"). The QPL is available on the Department's website. The QPL website is:

<http://www.ncdot.org/doh/preconstruct/traffic/ITSS/SMS/qpl/>

Furnish and install DMSs compliant with UL standards 48, 50, 879, and 1433.

Add and configure the new DMSs in the system using the Control Software and computer system. Furnish, install, test, integrate and make fully operational the new DMS.

Furnish operating DMS systems consisting of, but not limited to, the following:

- Full Matrix, 27 pixel high and 90 pixels wide LED DMS
- DMS controllers, Uninterruptible Power Supplies (UPS), cabinets and accessories with interconnect and power cabling and conduit
- Branch circuit conductors and related equipment
- All other equipment and incidentals required for furnishing, installing, and testing the DMS system and system components

Use only UL listed and approved electronic and electrical components in the DMS system.

B) MATERIALS

1. Environmental Requirements

Construct the DMS and DMS controller cabinet so the equipment within is protected against moisture, dust, corrosion, and vandalism.

Design the DMS system to comply with the requirements of Section 2.1 (Environmental and Operating Standards) of NEMA TS 4-2005.

2. Full Matrix LED Dynamic Message Sign (DMS)

Construct the DMS to display at least three lines of text that, when installed, are clearly visible and legible to a person with 20/20 corrected vision from a distance of 900 feet in advance of the DMS at an eye height of 3.5 feet along the axis.

When displaying three lines, each line must display at least 15 equally spaced and equally sized alphanumeric individual characters. Each character must be at least 18 inches in height and composed from a luminous dot matrix. Provide an entire LED matrix that is a minimum of 27 pixels high and 90 pixels wide.

3. DMS Enclosure

Comply with the requirements of Section 3 (Sign Mechanical Construction) of NEMA TS 4-2005 as it applies to walk-in enclosures. The following requirements complement TS 4-2005.

Construct the DMS with a metal walk-in enclosure excluding the face. Provide an aluminum walking platform inside the enclosure that is at least 28 inches wide. Ensure the width of the walking platform is free of obstructions to a height of 7 feet. Construct the enclosure of welded aluminum type 6061-T6, 5052-H38, 5052-H34, or of an Engineer approved alternate at least 1/8-inch thick. Perform all welding of aluminum and aluminum alloys in accordance with the latest edition of AWS D1.2, Structural Welding Code - Aluminum. Continuously weld the seams using Gas Metal Arc Welding (GMAW).

Provide all exterior and interior DMS enclosure surfaces with natural, mill-finish aluminum. Remove all grind marks and discoloration from the surfaces.

Provide corrosion resistant nuts, bolts, washers, and other mounting and bonding parts and components used on the exterior of the DMS enclosure and ensure they are sealed against water intrusion.

Provide one key lockable, hinged, gasket-sealed inspection door for service and maintenance along each side of the enclosure. Install one appropriately sized fire extinguisher within 12 inches of each maintenance door. Equip the DMS enclosure with internal fluorescent lighting controlled by timers installed close to each inspection door. Make certain no light emitted from the fluorescent tubes or any other light source inside the enclosure not comprising the display is leaked to the outside of the enclosure. Equip the door with a door-hold-open device. Install GFCI duplex utility receptacles every 6 feet along the width of the DMS in convenient locations for powered service tools.

Do not place a manufacturer name, logo, or other information on the front face of the DMS or shield visible to the motorist.

Provide power supply monitoring circuitry to detect power failure in the DMS and to automatically report this fault to the Control Software. This requirement is in addition to reporting power failure at the controller cabinet.

Do not paint the stainless steel bolts on the Z-bar assemblies used for mounting the enclosure.

4. DMS Interior Environment Control

Design the local field controller to monitor and control the interior DMS environment. Design environmental control to maintain the internal DMS temperature within $\pm 10^{\circ}$ F of the outdoor ambient temperature. Provide the DMS environmental control system with four primary subsystems as follows:

Internal Temperature Sensors – Provide the DMS with two internally mounted temperature sensors which are equipped with external thermocouples and which the field controller continuously monitors. Design the field controller to use this temperature information to determine when to activate and deactivate the environmental control systems described herein. Locate sensors on opposite ends of the upper 1/3 of the LED display matrix with their external thermocouples attached to and making contact with an LED pixel circuit board. Design the thermocouple and LED board to be easily detachable, in the event that one of the units requires removal and replacement. Provide sensors capable of measuring temperatures from -40° F to $+185^{\circ}$ F. Design the field controller to automatically shut down the LED display whenever one or both sensors indicates that LED board temperature has exceeded $+140^{\circ}$ F, and to automatically restart the LED display whenever the temperature falls below $+130^{\circ}$ F. Design both shutdown and re-start temperature thresholds to be user-programmable. Design the field controller to report sensor temperatures and DMS shutdown/re-start events to the DMS Control Software.

Housing Cooling System – Provide the DMS housing with a cooling system that circulates outside air into the DMS housing whenever the LED board temperature exceeds a user-programmable threshold. Provide this system with enough ventilation fans to exchange the internal DMS housing air volume at a minimum rate of 4 times per minute. Provide steel ball-bearing type fans.

Mount fans in a line across the upper rear wall of the DMS housing to direct air out of the cabinet. Provide one filtered air intake port for each exhaust fan. Locate intake ports in a line across the lower rear wall of the DMS housing. Provide intake ports with a removable filter that will remove airborne particles measuring 500 microns in diameter and larger. Provide a filter that is of a size and style that is commercially readily available. Program the field controller to activate the DMS housing cooling system whenever the LED board temperature exceeds +90° F and to turn the cooling system off whenever LED board temperature falls below +85° F. On the DMS housing rear exterior wall, cover all air intake and exhaust ports on their top, front, and sides by an aluminum shroud fabricated from 0.090-inch aluminum sheeting. Taper the shrouds at the top. Securely fasten shrouds to the DMS housing, and provide gaskets at the interface to prevent water from entering the DMS. Design all air filters and fans to be removable from inside the DMS housing. Provide the DMS housing cooling system with an adjustable timer that will turn fans off after the set time has expired. Provide a timer that is adjustable to at least 4 hours, and locate it just inside the DMS housing door, within easy reach of a maintenance technician standing outside the DMS doorway.

LED Display Cooling System – Provide the DMS with an LED display cooling system which directs air across the LED display modules whenever LED board temperature exceeds a user-programmable threshold. Direct fan-forced air vertically across the backside of the entire LED display matrix using multiple ball-bearing fans. Program the field controller to activate the LED cooling fan system whenever LED board temperature exceeds +90° F and to deactivate the system whenever LED board temperature falls to +85° F. Locate cooling fans so as not to hinder removal of LED display modules and driver boards.

Front Face Panel Defog/Defrost System – Provide the DMS with a defog/defrost system which circulates warm, fan-forced air across the inside of the polycarbonate front face whenever LED board temperature falls below a user-programmable threshold. Provide multiple steel ball-bearing fans that provide uniform airflow across the face panel. Program the field controller to activate the defog/defrost system whenever LED board temperature falls below +40° F and to deactivate the defog/defrost system whenever LED board temperature exceeds +106° F. Mount a 100-watt pencil-style heating element in front of each defog/defrost fan to warm the air directed across the DMS face. Design heating elements to be on only when the defog/defrost fans are on.

Install additional fans and/or heaters as needed to maintain the temperature inside the DMS enclosure within the operating temperature range of the equipment within the DMS enclosure as recommended by the equipment manufacturer(s).

5. Front Panel

Protect the DMS face with contiguous, weather-tight, removable panels. Manufacture these panels of sheets of polycarbonate, methacrylate, GE Lexan Type SG300 or equivalent that are ultraviolet protected, have an antireflection coating, and are a minimum of 1/8- inch thick. For substitutes, submit one 12” x 12” sample of the proposed material together with a description of the material attributes to the Engineer for

review and approval. Install a .09" aluminum mask on the front of the panel (facing the motorists) that contains a circular opening for each LED pixel. Prime and coat the front side of the aluminum mask, which faces the viewing motorists, with automotive-grade flat black acrylic enamel paint or an approved equivalent. Guarantee all painted surfaces provide a minimum outdoor service life of 20 years.

Design the panels so they will not warp nor reduce the legibility of the characters. Differential expansion of the DMS housing and the front panel must not cause damage to any DMS component or allow openings for moisture or dust. Glare from sunlight, roadway lighting, commercial lighting, or vehicle headlights must not reduce the legibility or visibility of the DMS. Install the panels so that a maintenance person can easily remove or open them for cleaning.

6. Display Modules

Manufacture each display module with a standard number of pixels, not to exceed an array of 9 x 5, which can be easily removed. Assemble the modules onto the DMS assemblies contiguously to form a continuous matrix to display the required number of lines, characters, and character height.

Design display modules that are interchangeable and replaceable without using special tools. Provide plug-in type power and communication cables to connect to a display module.

Construct each display module as a rectangular array of 5 horizontal pixels by 7 to 9 vertical pixels. Provide the module with an equal vertical and horizontal pitch between pixels, and columns that are perpendicular to the rows (i.e., no slant). Design each module to display:

- All upper and lower case letters.
- All punctuation marks.
- All numerals 0 to 9.
- Special user-created characters.

Display upper-case letters and numerals over the complete height of the module. Optimize the LED grouping and mounting angle within a pixel for maximum readability.

7. Discrete LEDs

Provide discrete LEDs with a nominal viewing cone of **30 degrees** with a half-power angle of 15 degrees measured from the longitudinal axis of the LED. Make certain, the viewing cone tolerances are as specified in the LED manufacturer's product specifications and do not exceed +/- 3 degrees half-power viewing angle of 30 degrees.

Provide LEDs that are untinted, non-diffused, high output solid state lamps utilizing indium gallium aluminum phosphide (InGaAlP) technology manufactured by Toshiba or Hewlett-Packard. No substitutions will be allowed. Provide T1 3/4, 0.2 inch size LEDs that emit a true amber color at a wavelength of 590 ± 5 nm.

Provide LEDs with a MTBF (Mean Time Before Failure) of at least 100,000 hours of permanent use at an operating point of 140° F or below at a specific forward current of

20mA. Discrete LED failure is defined as the point at which the LED's luminous intensity has degraded to 50% or less of its original level.

Obtain the LEDs used in the display from a single LED manufacturer that have a single part number. Obtain them from batches sorted for luminous output, where the highest luminosity LED is not more than fifty percent more luminous than the lowest luminosity LED when the LEDs are driven at the same forward current. Do not use more than two successive and overlapping batches in the LED display. Document the procedure to be used to comply with this requirement as part of the material submittal.

Individually mount the LEDs on circuit boards that are at least 1/16" thick FR-4 fiberglass, flat black printed circuit board in a manner that promotes cooling. Protect all exposed metal on both sides of the LED pixel board (except the power connector) from water and humidity exposure by a thorough application of acrylic conformal coating. Design the boards so bench level repairs to individual pixels, including discrete LED replacement and conformal coating repair is possible.

Operate the LED display at a low internal DC voltage not to exceed 24 Volts.

Design the LED display operating range to be -20° F to $+140^{\circ}$ F at 95% relative humidity, non-condensing.

Supply the LED manufacturer's technical specification sheet with the material submittals.

8. LED Power Supplies

Power the LED Display by means of multiple regulated switching DC power supplies that operate from 120 volts AC input power and have an output of 48 volts DC or less. Wire the supplies in a redundant parallel configuration that uses multiple power supplies per display. Provide the supplies with current sharing capability that allows equal amounts of current to their portion of the LED display. Provide power supplies rated such that if one supply fails the remaining supplies will be able to operate their portion of the display under full load conditions (i.e. all pixels on at maximum brightness) and at a temperature of 140° F.

Provide power supplies to operate within a minimum input voltage range of $+90$ to $+135$ volts AC and within a temperature range of -22° F to 140° F. Power supply output at 140° F must not deteriorate to less than 65% of its specified output at 70° F. Provide power supplies that are overload protected by means of circuit breakers, that have an efficiency rating of at least 75%, a power factor rating of at least .95, and are UL listed. Provide all power supplies from the same manufacturer and with the same model number. Design the power driver circuitry to minimize power consumption.

Design the field controller to monitor the operational status (normal or failed) of each individual power supply and be able to display this information on the Client Computer screen.

9. LED Pixels

A pixel is defined as the smallest programmable portion of a display module that consists of a cluster of closely spaced discrete LEDs. Design each pixel to be a maximum of 2 inches in diameter.

Construct the pixels with two strings of LEDs. It is the manufacturer's responsibility to determine the number of LEDs in each string to produce the candela requirement as stated herein.

Ensure each pixel produces a luminous intensity of 40 Cd when driven with an LED drive current of 20 mA per string.

Power the LEDs in each pixel in strings. Use a redundant design so that the failure of an LED in one string does not affect the operation of any other string within the pixel. Provide the sign controller with the ability to detect the failure of any LED string and identify which LED string has failed. Submit a complete schematic of the LED power and driver circuits with the material submittals.

10. Character Display

Design display modules to be easily removable without the use of tools. Position cooling fans so they do not prevent removal of an LED pixel board or driver board.

Use continuous current to drive the LEDs at the maximum brightness level. Design the light levels to be adjustable for each DMS / controller so the Engineer may set levels to match the luminance requirements at each installation site.

Design the controller to automatically detect failed LED strings or drivers and initiate a report of the event to the Control Software. Design the controller to be able to read the internal temperature of the DMS enclosure and the ambient temperature outside the DMS enclosure and report these to the Control Software.

11. Display Capabilities

Design the DMS with at least the following message displays:

Static display

Flashing display with Dynamic flash rates

At least two alternating Static and / or Flashing sequences (multi-page messages)

12. DMS Mini Controller

Furnish and install a mini controller inside the DMS that is interconnected with the main controller using a fiber optic cable, CAT-5 cable, or an approved alternate. The mini controller will enable a technician to perform all functions available from the main controller. Provide the mini controller with an LCD/keypad interface. Size the LCD display screen to allow preview of an entire one-page message on one screen. Provide a 4 X 4 keypad.

Alternatively, install an EIA/TIA-232E port inside the DMS enclosure to enable a maintenance technician to communicate with the DMS main controller and obtain access to and perform all functions of the main controller using a laptop computer.

13. DMS Enclosure Structure Mounting

Mount the DMS enclosure and interconnect system securely to the supporting structures of the pedestal mount. Design the DMS enclosure supports and structure to allow full access to the DMS enclosure inspection door. Furnish and install U-bolt connections of

hanger beams to the assembly truss chords with a double nut at each end of the U-bolt. Bring the double nuts tight against each other by the use of two wrenches.

Submit plans for the DMS enclosure, structure, mounting description and calculations to the Engineer for approval. Have such calculations and drawings approved by a Professional Engineer registered in the state of North Carolina, and bear his signature, seal, and date of acceptance.

Provide removable lifting eyes or the equivalent on the DMS enclosure rated for its total weight to facilitate handling and mounting the DMS enclosure.

Design the DMS structure to conform to the applicable requirements of the *Standard Specifications for Structural Supports for Highway Signs, Luminaires*, and the section titled "DMS Assemblies" of these Project Special Provisions.

14. DMS / DMS Controller Interconnect

Furnish and install all necessary cabling, conduit, and terminal blocks to connect the DMS and the DMS controller. Use approved manufacturer's specifications for cable and conduit types and sizes. Use fiber optic cable to interconnect sign and controller. Install fiber optic interconnect centers in the sign enclosure and cabinet to securely install and terminate the fiber optic cable. Submit material submittal cut sheets for the interconnect center.

Furnish and install one DMS controller with accessories per DMS in a protective cabinet. Mount the controller cabinet on the DMS support structure. Install cabinet so that the height to the middle of the cabinet is 4 feet. Ensure a minimum of 3 feet level working surface under each cabinet that provides maintenance technicians with a safe working environment.

Provide the DMS controller as a software-oriented microprocessor and with resident software stored in non-volatile memory. The Control Software, controller and communications must comply with the NTCIP Standards identified in these Project Special Provisions. Provide sufficient non-volatile memory to allow storage of at least 500 multi-page messages and a test pattern program.

Furnish the controller cabinet with, but not limited to, the following:

- Power supply and distribution assemblies
- Power line filtering hybrid surge protectors
- Radio Interference Suppressor
- Communications surge protection devices
- Industrial-Grade UPS system and local disconnect
- Microprocessor-based controller
- Display driver and control system (unless integral to the DMS)
- Industrial-grade dial-up modem and interface cable
- Industrial-grade telephone line surge and lightning protector
- Serial interface port for local laptop computer

- Local user interface
- Interior lighting and duplex receptacle
- Adjustable shelves as required for components
- Temperature control system
- All interconnect harnesses, connectors, and terminal blocks
- All necessary installation and mounting hardware

Furnish the DMS controller and associated equipment completely housed in a NEMA 3R cabinet made from 5052-H32 sheet aluminum at least 1/8" thick. Use natural aluminum cabinets. Perform all welding of aluminum and aluminum alloys in accordance with the latest edition of AWS D1.2, Structural Welding Code - Aluminum. Continuously weld the seams using Gas Metal Arc Welding (GMAW).

Slant the cabinet roof away from the front of the cabinet to prevent water from collecting on it.

Do not place a manufacturer name, logo, or other information on the faces of the controller cabinet visible to the motorist.

Provide cabinets capable of housing the components and sized to fit space requirement. Design the cabinet layout for ease of maintenance and operation, with all components easily accessible. Submit a cabinet layout plan for approval by the Engineer.

Locate louvered vents with filters in the cabinet to direct airflow over the controller and auxiliary equipment, and in a manner that prevents rain from entering the cabinet. Fit the inside of the cabinet, directly behind the vents, with a replaceable, standard-size, commercially available air filter of sufficient size to cover the entire vented area.

Provide a torsionally rigid door with a continuous stainless steel hinge on the side that permits complete access to the cabinet interior. Provide a gasket as a permanent and weather resistant seal at the cabinet door and at the edges of the fan / exhaust openings. Use a non-absorbent gasket material that will maintain its resiliency after long-term exposure to the outdoor environment. Construct the doors so that they fit firmly and evenly against the gasket material when closed. Provide the cabinet door with louvered vents and air filters near the bottom as described in the paragraph above.

Provide a Plexiglas rack of appropriate size at a convenient location on the inside of the door to store the cabinet wiring diagrams and other related cabinet drawings. Provide a Corbin #2 main door lock made of non-ferrous or stainless steel material. Key all locks on the project alike, and provide 10 keys to the Engineer. In addition, design the handle to permit pad-locking.

Provide the interior of the cabinet with ample space for housing the controller and all associated equipment and wiring; use no more than 75% of the useable space in the cabinet. Provide ample space in the bottom of the cabinet for the entrance and exit of all power, communications, and grounding conductors and conduit.

Arrange the equipment so as to permit easy installation of the cabling through the conduit so that they will not interfere with the operation, inspection, or maintenance of the unit. Provide adjustable metal shelves, brackets, or other support for the controller unit and

auxiliary equipment. Leave a 3 inch minimum clearance from the bottom of the cabinet to all equipment, terminals, and bus bars.

Provide power supply monitoring circuitry to detect power failure and to automatically report the occurrence to the Control Software.

Install two 15-watt fluorescent light strips with shields, one in the top of the cabinet and the other under the bottom shelf. Design both lights to automatically turn on when the cabinet door is opened and turn off when the door closes.

Mount and wire a 120V ($\pm 10\%$) GFCI duplex receptacle of the 3-wire grounding type in the cabinet in a location that presents no electrical hazard when used by service personnel for the operation of power tools and work lights.

No cabinet resident equipment may utilize the GFCI receptacle. Furnish one spare non-GFCI receptacle for future equipment.

Mount a bug-proof and weatherproof thermostatically controlled fan and safety shield in the top of the cabinet. Size the fan to provide at least for two air exchanges per minute. Fuse the fan at 125% of the capacity of the motor. The magnetic field of the fan motor must not affect the performance of the control equipment. Use a fan thermostat that is manually adjustable to turn on between 80°F and 160°F with a differential of not more than 10°F between automatic turn-on and turn-off. Mount it in an easily accessible location, but not within 6 inches of the fan.

Install additional fans and/or heaters as needed to maintain the temperature inside the cabinet within the operating temperature range of the equipment within the cabinet as recommended by equipment manufacturer(s).

15. Wiring

The requirements stated herein apply wherever electrical wiring is needed for any DMS system assemblies and subassemblies such as controller cabinet, DMS enclosure, electrical panel boards and etc.

Neatly arrange and secure the wiring inside the cabinet. Where cable wires are clamped to the walls of the control cabinet, provide clamps made of nylon, metal, plastic with rubber or neoprene protectors, or similar. Lace and jacket all harnesses, or tie them with nylon tie wraps spaced at 6 inches maximum to prevent separation of the individual conductors.

Individually and uniquely label all conductors. Ensure all conductor labels are clearly visible without moving the conductor. Connect all terminal conductors to the terminal strip in right angles. Remove excess conductor before termination of the conductor. Mold the conductor in such a fashion as to retain its relative position to the terminal strip if removed from the strip. Do not run a conductor across a work surface with the exception of connecting to that work surface. No conductor bundles can be support by fasteners that support work surfaces. Install all connectors, devices and conductors in accordance to manufactures guidelines. Comply with the latest NEC guideline in effect during installation. No conductor or conductor bundle may hang loose or create a snag hazard. Protect all conductors from damage. Ensure all solder joints are completed using industry accepted practices and will not fail due to vibration or movement. Protect lamps and control boards from damage.

No splicing will be allowed for feeder conductors and communication cables from the equipment cabinet to the DMS enclosure.

Insulate all conductors and live terminals so they are not hazardous to maintenance personnel.

Route and bundle all wiring containing line voltage AC and / or shield it from all low voltage control circuits. Install safety covers to prevent accidental contact with all live AC terminals located inside the cabinet.

Use industry standard, keyed-type connectors with a retaining feature for connections to the controller.

Label all equipment and equipment controls clearly.

Supply each cabinet with one complete set of wiring diagrams that identify the color-coding or wire tagging used in all connections. Furnish a water-resistant packet adequate for storing wiring diagrams, operating instructions, and maintenance manuals with each cabinet.

16. Power Supply and Circuit Protection

Design the DMS and controller for use on a system with a line voltage of $120V \pm 10\%$ at a frequency of $60 \text{ Hz} \pm 3 \text{ Hz}$. Under normal operation, do not allow the voltage drop between no load and full load of the DMS and its controller to exceed 3% of the nominal voltage.

Blackout, brownout, line noise, chronic over-voltage, sag, spike, surge, and transient effects are considered typical AC voltage defects. Protect the DMS system equipment so that these defects do not damage the DMS equipment or interrupt their operation. Equip all cabinets with devices to protect the equipment in the cabinet from damage due to lightning and external circuit power and current surges.

17. Circuit Breakers

Protect the DMS controller, accessories, and cabinet utilities with thermal magnetic circuit breakers. Provide the controller cabinet with a main circuit breaker sized according to the NEC. Use appropriately sized branch circuit breakers to protect the controller and accessories and for servicing DMS equipment and cabinet utilities.

18. Surge Suppressor

Install and clearly label filtering hybrid power line surge protectors on the load side of the branch circuit breakers in a manner that permits easy servicing. Ground and electrically bond the surge protector to the cabinet within 2 inches.

Provide power line surge protector that meets the following requirements:

Peak surge current occurrences	20 minimum
• Peak surge current for an 8 x 20 microsecond waveshape	50,000 amperes
• Energy Absorption	• > 500 Joules
• Clamp voltage	• 240 volts

Response time	<1 nanosecond
Minimum current for filtered output	15 amperes for 120VAC*
Temperature range	-40°F to +158°F

*Capable of handling the continuous current to the equipment

19. Radio Interference Suppressor

Provide each controller cabinet with sufficient electrical and electronic noise suppression to enable all equipment in it to function properly. Provide one or more radio interference suppressors (RIS) connected between the stages of the power line surge suppressor that minimize interference generated in the cabinet in both the broadcast and the aircraft frequencies. Each RIS must provide a minimum attenuation of 50 decibels over a frequency range of 200 KHz to 75 MHz. Clearly label the suppressor(s) and size them at least at the rated current of the main circuit breaker but not less than 50 amperes.

Provide RIS that are hermetically sealed in a substantial metal case which is filled with a suitable insulating compound and have nickel-plated 10/24 brass stud terminals of sufficient external length to provide space to connect #8 AWG wires. Mount them so that the studs cannot be turned in the case. Properly insulate ungrounded terminals from each other, and maintain a surface linkage distance of not less than ¼” between any exposed current conductor and any other metallic parts. The terminals must have an insulation factor of 100-200 MΩ, dependent on external circuit conditions. Use RIS designed for 120 VAC ± 10%, 60Hz, and which meet the standards of UL and the Radio Manufacturers Association.

20. Communications Surge Protector

Equip the cabinet with properly labeled hybrid data line surge protectors that meet the following general requirements:

• Surge current occurrences at 2000 ampere, 8 x 20 microsecond waveform	> 80
Surge current occurrences at 400 ampere, 10x700 microsecond waveform	> 80
• Peak surge current for 8 x 20 microsecond waveform	10,000 A (2500 A/line)
Peak surge current for 10x700 microsecond waveform	500 A/line
Response time	< 1 nanosecond
Series resistance	< 15 Ω
Average capacitance	1500 pF
Temperature range	-10°F to 150°F
Clamp Voltage	As required to match equipment in application

21. Lightning Arrester

Protect the system with an UL-approved lightning arrester installed at the main service disconnect that meets the following requirements:

Type of design	Silicon Oxide Varistor
Voltage	120/240 Single phase, 3 wires
Maximum current	100,000 amps
Maximum energy	3000 joules per pole
Maximum number of surges	Unlimited
Response time one milliamp test	5 nanoseconds
Response time to clamp 10,000 amps	10 nanoseconds
Response time to clamp 50,000 amps	25 nanoseconds
Leak current at double the rated voltage	None
Ground Wire	Separate

22. Uninterruptible Power Supply (UPS)

Provide the cabinet with an industrial grade power conditioning UPS unit to supply continuous power to operate the equipment connected to it if the primary power fails. The UPS must detect a power failure and provide backup power within 20 milliseconds. Transition to the UPS source from primary power must not cause loss of data or damage to the equipment being supplied with backup power. Provide an UPS with at least three outlets for supplying conditioned AC voltage to the DMS controller and modem. Provide a unit to meet the following requirements:

- Input Voltage Range: 120VAC +12%, -25%
- Power Rating: 1000 VA, 700 Watts
- Input Frequency: 45 to 65 Hz
- Input Current: 7.2A
- Output Voltage: 120VAC +/- 3%
- Output Frequency: 50/60 +/-1 Hz
- Output Current: 8.3A
- Output Crest Factor Ration: @50% Load Up to 4.8:1
@75% Load Up to 3.2:1
@100% Load Up to 2.4:1
- Output THD: 3% Max. (Linear)
5% Max. (Non-Linear)

- Output Overload: 110% for 10 min; 200% for 0.05 sec.
- Output Dynamic Response: +/- 4% for 100% Step Load Change
- 0.5 ms Recovery Time.
- Output Efficiency @ 100% Load: 90% (Normal Mode)
- Operating Temperature: -40 °F to +165 °F
- Humidity: 0% to 95% Non-condensing
- Remote Monitoring Interface: RS-232
- Protection:
 - Input/Output Short Circuit
 - Input/Output Overload
 - Excessive Battery Discharge
- Specifications: UL1778, FCC Class A, IEEE 587

Provide the UPS unit capable of supplying 30 minutes of continuous backup power to the equipment connected to it when the equipment is operating at full load.

23. Controller Communications Interface

Provide the controller with the following interface ports:

An EIA/TIA-232E port for remote communication using NTCIP

An 10/100 Ethernet port for remote communication using NTCIP

An EIA/TIA-232E port for onsite access using a laptop

An EIA/TIA-232E auxiliary port for communication with a field device such as a UPS

Fiber Optic ports for communication with the sign

RJ45 ports for communication with the sign using CAT-5 cable

RJ45 ports for communication with mini-controller located inside the sign enclosure

24. Controller Local User Interface

Provide the controller with a Local User Interface (LUI) for at least the following functions:

On / Off Switch: controls power to the controller.

Control Mode Switch: for setting the controller operation mode to either remote or local mode.

LCD Display and Keypad: Allow user to navigate through the controller menu for configuration (display, communications parameter, etc) running diagnostics, viewing peripherals status, message creation, message preview, message activation, and etc. Furnish a LCD display with a minimum size of 240x64 dots with LED back light.

25. Controller Address

Assign each DMS controller a unique address. Preface all commands from the Control Software with a particular DMS controller address. The DMS controller compares its address with the address transmitted; if the addresses match, then the controller processes the accompanying data.

26 Controller Functions

Design the DMS controller to continuously control and monitor the DMS independent of the Control Software. Design the controller to display a message on the sign sent by the Control Software, a message stored in the sign controller memory, or a message created on-site by an operator using the controller keypad.

Provide the DMS controller with a watchdog timer to detect controller failures and to reset the microprocessor, and with a battery backed-up clock to maintain an accurate time and date reference. Set the clock through an external command from the Control Software or the Local User Interface.

27 DMS Controller Memory

Furnish each DMS controller with non-volatile memory. Use the non-volatile memory to store and reprogram at least one test pattern sequence and 500 messages containing a minimum of two pages of 45 characters per page. The Control Software can upload messages into and download messages from each controller's non-volatile memory remotely.

Messages uploaded and stored in the controller's non-volatile memory may be erased and edited using the Control Software and the controller. New messages may be uploaded to and stored in the controller's non-volatile memory using the Control Software and the controller.

28. Telephone Modem

Furnish and install industrial-grade modems with a data rate of 56 kbps. The modem must have a watchdog circuitry to continuously monitor the power supply, internal hardware, and operational software. In the event of a hardware or software problem, provide a modem that automatically resets itself.

29. Telephone Line Surge and Lightning Protector

Provide telephone line surge and lightning protectors that are UL rated for industrial use and meet the following specifications:

Technology	Solid state with fast acting fuses and resistors
Usage	Telephone Line
Ports Protected	1 (2 lines per port)
Connectors	RJ11/12
Surge Capacity	1.9 kA / line
Clamp & Rated Voltage	270 V and 200 V
Max Frequency	50 MHz
Operating Temperature	-40° F to 185 ° F
Max Inline Resistance	22 Ohms
Ratings	UL 497A, IEC801-5, CCITT (ITU-T) K17

30. Photo-Electric Sensors

Install three photoelectric sensors with ½ inch minimum diameter photosensitive lens inside the DMS enclosure. Use sensors that will operate normally despite continual exposure to direct sunlight. Place the sensors so they are accessible and field adjustable. Point one sensor north or bottom of the sign. Place the other two, one on the back wall and one on the front wall of the sign enclosure. Alternate designs maybe accepted, provided the sensor assemblies are accessible and serviceable from inside the sign enclosure.

Provide controls so that the Engineer can field adjust the following:

- The light level emitted by the pixels elements in each Light Level Mode.
- The ambient light level at which each Light Level Mode is activated.

31. Equipment List

Provide a general description of all equipment and all information necessary to describe the basic use or function of the major system components. Include a general "block diagram" presentation. Include tabular charts listing auxiliary equipment, if any is required. Include the nomenclature, physical and electrical characteristics, and functions of the auxiliary equipment unless such information is contained in an associated manual; in this case include a reference to the location of the information. Include an itemized list of equipment costs.

Include a table itemizing the estimated average and maximum power consumption for each major piece of equipment.

32. Physical Description

Provide a detailed physical description of size, weight, center of gravity, special mounting requirements, electrical connections, and all other pertinent information necessary for proper installation and operation of the equipment.

33. Parts List

Provide a parts list that contains all information needed to describe the characteristics of the individual parts, as required for identification. Include a list of all equipment within a group and a list of all assemblies, sub-assemblies, and replacement parts of all units. Arrange this data in a table, in alpha-numerical order of the schematic reference symbols, which gives the associated description, manufacturer's name, and part number, as well as alternate manufacturers and part numbers. Provide a table of contents or other appropriate grouping to identify major components, assemblies, etc.

34. Character Set Submittal

Submit an engineering drawing of the DMS character set including 26 upper case and lower case letters, 10 numerals, an asterisk (*), a dash, a plus sign (+), a designated lane diamond, a slash, an ampersand, and arrows at 0, 45, 90, 135, 180, 225, 270, and 315 degrees.

35. Wiring Diagrams

Provide a wiring diagram for each DMS and each controller cabinet, as well as interconnection wiring diagrams for the system as a whole.

Provide complete and detailed schematic diagrams to component level for all DMS assemblies and subassemblies such as driver boards, control boards, DMS controller, power supplies, and etc. Ensure that each schematic enables an electronics technician to successfully identify any component on a board or assemblies and trace its incoming and outgoing signals.

36. Routine of Operation

Describe the operational routine, from necessary preparations for placing the equipment into operation to securing the equipment after operation. Show appropriate illustrations with the sequence of operations presented in tabular form wherever applicable. Include in this section a total list of the test instruments, aids and tools required to perform necessary measurements and measurement techniques for each component, as well as set-up, test, and calibration procedures.

37. Maintenance Procedures

Specify the recommended preventative maintenance procedures and checks at pre-operation, monthly, quarterly, semi-annual, annual, and "as required" periods to assure equipment operates reliably. List specifications (including tolerances) for all electrical, mechanical, and other applicable measurements and / or adjustments.

38. Repair Procedures

Include in this section all data and step-by-step procedures necessary to isolate and repair failures or malfunctions, assuming the maintenance technicians are capable of analytical reasoning using the information provided in the section titled "Wiring Diagrams and Theory of Operation."

Describe accuracy, limits, and tolerances for all electrical, physical, or other applicable measurements. Include instructions for disassemblies, overhaul, and re-assemblies, with shop specifications and performance requirements.

Give detailed instructions only where failure to follow special procedures would result in damage to equipment, improper operation, danger to operating or maintenance personnel, etc. Include such instructions and specifications only for maintenance that specialized technicians and engineers in a modern electromechanical shop would perform. Describe special test set-up, component fabrication, and the use of special tools, jigs, and test equipment.

39. Field Trial

At the request of the Engineer, supply a three character demonstration module with characters of the size and type specified for the project, an appropriate control device and power supply to allow character display within 30 working days of the request. Perform a field trial on this module at a time and location selected by the Engineer.

This trial will allow the Engineer or his selected representatives to test the readability of the DMS at the maximum distance required for specified character size. Test the module with the sun directly above the DMS, and near the horizon in front of and behind the DMS (washout and back-lit conditions).

C) CONSTRUCTION METHODS

1. Description

This article establishes practices and procedures and gives minimum standards and requirements for the installation of Dynamic Message Sign systems, auxiliary equipment and the construction of related structures.

Provide electrical equipment described in this specification that conforms to the standards of NEMA, UL, or Electronic Industries Association (EIA), wherever applicable. Provide connections between controllers and electric utilities that conform to NEC standards. Express wire sizes according to the American Wire Gauge (AWG).

Provide stainless steel screws, nuts, and locking washers in all external locations. Do not use self-tapping screws unless specifically approved by the Engineer. Use parts made of corrosion-resistant materials, such as plastic, stainless steel, brass, or aluminum. Use construction materials that resist fungus growth and moisture deterioration. Separate dissimilar metals by an inert dielectric material.

2. Layout

The Engineer will establish the actual location of the Dynamic Message Sign assembly. It is the Contractor's responsibility to ensure proper elevation, offset, and orientation of all DMS assemblies. Make actual field measurements to place conduit and equipment at the required location. Submit a drawing showing all underground conduits and cables dimensioned from fixed objects or station marks.

3. Construction Submittal

When the work is complete, submit "as built" plans, inventory sheets, and any other data required by the Engineer to show the details of actual construction and installation and any modifications made during installation.

The "as built" plans will show: the DMS, controller, and service pole locations; DMS enclosure and controller cabinet wiring layouts; and wire and conduit routing. Include detailed drawings that identify the routing of all conductors in the system by cable type, color code, and function. Clearly label all equipment in the DMS system, controller cabinet, and DMS enclosure.

4. Conduit

Install the conduit system in accordance with section 1097 of Standard Specification and NEC requirements for an approved watertight raceway.

Make bends in the conduit so as not to damage it or change its internal diameter. Install watertight and continuous conduit with as few couplings as standard lengths permit.

Clean conduit before, during, and after installation. Install conduit in such a manner that temperature changes will not cause elongation or contraction that might damage the system.

Attach the conduit system to and install along the structural components of the DMS structure assemblies with beam clamps or stainless steel strapping. Install strapping according to the strapping manufacturer's recommendations. Do not use welding or drilling to fasten conduit to structural components. Space the fasteners at no more than 4 feet for conduit 1.5 inches and larger or 6 feet for conduit smaller than 1.25 inches. Place fasteners no more than 3 feet from the center of bends, fittings, boxes, switches, and devices.

Do not exceed the appropriate fill ratio on all cable installed in conduit as specified in the NEC.

5. Wiring Methods

Do not pull permanent wire through a conduit system until the system is complete and has been cleaned.

Color-code all conductors per the NEC. Use approved marking tape, paint, sleeves or continuous colored conductors for No.8 AWG and larger. Do not mark a white conductor in a cable assemblies any other color.

Bury underground circuits at the minimum depth indicated in the Standard Specifications and Standard Drawings and surround it with at least 3 inches of sand or earth back-fill free of rocks and debris. Compact backfill in 6 inch layers. Do not splice underground circuits unless approved by the Engineer.

6. Equipment and Cabinet Mounting

Mount all the DMS equipment securely and in conformance with the dimensions shown in the DMS shop drawings. Install fasteners as recommended by the manufacturer and space them evenly. Use all mounting holes and attachment points for attaching the DMS enclosure and controller cabinet to the structure.

Drill holes for expansion anchors of the size recommended by the manufacturer of the anchors and thoroughly clean them of all debris.

Provide one key-operated, pin tumbler, dead bolt padlock, with brass or bronze shackle and case, conforming to Military Specification MIL-P-17802E (Grade I, Class 2, Size 2,

Style A) for each electrical panel and switch on the project. Key all padlocks alike, and provide 10 keys to the Engineer.

Provide cabinets with all mounting plates, anchor bolts, and any other necessary mounting hardware in accordance with these Project Special Provisions and the DMS drawings.

Seal all unused conduit installed in cabinets at both ends to prevent water and dirt from entering the conduit and cabinet with approved sealing material.

Install a ground bushing attached inside the cabinet on all metal conduits entering the cabinet. Connect these ground bushings to the cabinet ground bus.

7. Work Site Clean-Up

Clean the site of all debris, excess excavation, waste packing material, wire, etc. Clean and clear the work site at the end of each workday. Do not throw waste material in storm drains or sewers.

NTCIP REQUIREMENTS

This section defines the detailed NTCIP requirements for the DMSs covered by these Project Special Provisions.

REFERENCES

This specification references several standards through their NTCIP designated names. The following list provides the full reference to the current version of each of these standards.

Implement the most recent version of the standard including any and all Approved or Recommended Amendments to these standards for each NTCIP Component covered by these project specifications.

Table 1: NTCIP Standards

Abbreviated Number	Full Number	Title
NTCIP 1101	NTCIP 1101:1997	<i>Simple Transportation Management Framework</i>
NTCIP 1201	NTCIP 1201:1997	<i>Global Object Definitions</i>
NTCIP 1203	NTCIP 1203:1997	<i>Object Definitions for Dynamic Message Signs</i>
NTCIP 2001	NTCIP 2001:1997 •	<i>Class B Profile</i>
NTCIP 2101	NTCIP 2101	<i>SP-PMPP/232 Subnet Profile for PMPP</i>

		<i>over RS-232</i>
NTCIP 2102	NTCIP 2102	<i>SP-PMPP/FSK Subnet Profile for PMPP over FSK Modem</i>
NTCIP 2103	NTCIP 2103	<i>SP-PPP/232 Subnetwork Profile for PPP over RS232 (Dial Up)</i>
NTCIP 2104	NTCIP 2104	<i>SP-Ethernet Subnet Profile for Ethernet</i>
NTCIP 2201	NTCIP 2201	<i>TP-Null Transport Profile</i>
NTCIP 2202	NTCIP 2202	<i>TP-Internet Internet Transport Profile (TCP/IP and UDP/IP)</i>
NTCIP 2301	NTCIP 2301	<i>AP-STMF AP for Simple Transportation Management Framework</i>

A) General Requirements

1 Subnet Level

Ensure each serial port on each NTCIP Component supports NTCIP 2103 over a dial-up connection with a contractor provided external modem with data rates of 28.8 kbps, 19.2 kbps, 14.4 kbps, 9600 bps, 4800 bps, 2400 bps, 1200 bps, 600 bps, and 300 bps. Enable the NTCIP Component to make outgoing and receive incoming calls as necessary and support the following modem command sets:

- Hayes AT - Command Set
- MNP5
- MNP10
- V.42bis

Ensure each serial port on each NTCIP Component supports NTCIP 2103 over a null-modem connection with data rates of 19.2 kbps, 14.4 kbps, 9600 bps, 4800 bps, 2400 bps, 1200 bps, 600 bps, and 300 bps.

Ensure each serial port on each NTCIP Component supports NTCIP 2101 with data rates of 9600 bps, 4800 bps, 2400 bps, 1200 bps, 600 bps, and 300 bps.

Ensure NTCIP components support NTCIP 2102 and NTCIP 2104.

NTCIP Components may support additional Subnet Profiles at the manufacturer's option. At any one time, make certain only one Subnet Profile is active on a given serial port of the NTCIP Component. Ensure the NTCIP Component can be configured to allow the field technician to activate the desired Subnet Profile and provide a visual indication of the currently selected Subnet Profile.

2. Transport Level

Ensure each NTCIP Component complies with NTCIP 2201 and 2202.

NTCIP Components may support additional Transport Profiles at the manufacturer's option. Ensure Response datagrams use the same Transport Profile used in the request. Ensure each NTCIP Component supports the receipt of datagrams conforming to any of the identified Transport Profiles at any time.

3. Application Level

Ensure each NTCIP Component complies with NTCIP 1101 and 2301 and meets the requirements for Conformance Level 1 (NOTE - See Amendment to standard).

Ensure each NTCIP Component supports SNMP traps. An NTCIP Component may support additional Application Profiles at the manufacturer's option. Ensure Responses use the same Application Profile used by the request. Ensure each NTCIP Component supports the receipt of Application data packets at any time allowed by the subject standards.

4. Information Level

Guarantee each NTCIP Component provides Full, Standardized Object Range Support of all objects required by these Special Provisions unless otherwise indicated below. Make certain the maximum Response Time for any object or group of objects is 200 milliseconds.

Design the DMS to support all mandatory objects of all mandatory Conformance Groups as defined in NTCIP 1201 and NTCIP 1203. Table 2 indicates the modified object requirements for these mandatory objects.

Table 2: Modified Object Ranges for Mandatory Objects

Object	Reference	Project Requirement
ModuleTableEntry	NTCIP 1201 Clause 2.2.3	Contains at least one row with moduleType equal to 3 (software). The moduleMake specifies the name of the manufacturer, the moduleModel specifies the manufacturer's name of the component and the modelVersion indicates the model version number of the component.

MaxGroupAddresses	NTCIP 1201 Clause 2.7.1	At least 1
CommunityNamesMax	NTCIP 1201 Clause 2.8.2	At least 3
DmsNumPermanentMsg	NTCIP 1203 Clause 2.6.1.1.1.1	At least 1*
DmsMaxChangeableMsg	NTCIP 1203 Clause 2.6.1.1.1.3	At least 21
DmsFreeChangeableMemory	NTCIP 1203 Clause 2.6.1.1.1.4	At least 20 when no messages are stored.
DmsMessageMultiString	NTCIP 1203 Clause 2.6.1.1.1.8.3	The DMS supports any valid MULTI string containing any subset of those MULTI tags listed in Table 4
DmsControlMode	NTCIP 1203 Clause 2.7.1.1.1.1	Support at least the following modes: Local External central CentralOverride

* Ensure the Permanent Messages display the content shown in Table 3.

Ensure the sign blanks if a command to display a message contains an invalid Message CRC value for the desired message.

Table 3: Content of Permanent Messages

Perm. Msg. Num.	Description
1	Permanent Message #1 blanks the display (i.e., consist of and empty MULTI string). It has a run-time priority of one (1).

Table 4: Required MULTI Tags

Code	Feature
f1	field 1 - time (12hr)
f2	field 2 - time (24hr)
f8	field 8 – day of month
f9	field 9 – month

f10	field 10 - 2 digit year
f11	field 11 - 4 digit year
fl (and /fl)	flashing text on a line by line basis with flash rates controllable in 0.5 second increments.
fo	Font
jl2	Justification – line – left
jl3	Justification – line – center
jl4	Justification – line – right
jl5	Justification – line – full
jp2	Justification – page – top
jp3	Justification – page – middle
jp4	Justification – page – bottom
Mv	moving text
Nl	new line
Np	new page, up to 2 instances in a message (i.e., up to 3 pages/frames in a message counting first page)
Pt	page times controllable in 0.5 second increments.

The NTCIP Component implements all mandatory and optional objects of the following optional conformance groups with FSORS.

5. Test Heading

Time Management

As defined in NTCIP 1201

Timebase Event Schedule

As defined in NTCIP 1201. The following list indicates the modified object requirements for this conformance group.

Table 5: Modified Object Ranges for the Timebase Event Schedule Conformance Group

Object	Reference	Project Requirement
--------	-----------	---------------------

MaxTimeBaseScheduleEntries	NTCIP 1201 Clause 2.4.3.1	At least 28
maxDayPlans	NTCIP 1201 Clause 2.4.4.1	At least 14
maxDayPlanEvents	NTCIP 1201 Clause 2.4.4.2	At least 10

6. Report

As defined in NTCIP 1201. The following list indicates the modified object requirements for this conformance group.

Table 6: Modified Object Ranges for the Report Conformance Group

Object	Reference	Project Requirement
maxEventLogConfigs	NTCIP 1201 Clause 2.5.1	At least 50
eventConfigurationMode	NTCIP 1201 Clause 2.4.3.1	The NTCIP Component supports the following Event Configuration Modes: onChange greaterThanValue smallerThanValue
MaxEventLogSize	NTCIP 1201 Clause 2.5.3	At least 200
MaxEventClasses	NTCIP 1201 Clause 2.5.5	At least 16

B) PMPP

1. Font Configuration

As defined in NTCIP 1203. The following list indicates the modified object requirements for this conformance group.

Table 7: Modified Object Ranges for the Font Configuration Conformance Group

Object	Reference	Project Requirement
NumFonts	NTCIP 1203 Clause 2.4.1.1.1.1	At least 4*
MaxFontCharacters	NTCIP 1203 Clause 2.4.1.1.1.3	At least 127**

*Upon delivery, the first font is a standard 18" font. The second font is a double-stroke 18" font. The third font is a 28" font. The fourth font is empty.

**Upon delivery, the first three font sets are configured in accordance with the ASCII character set for the following characters:

- “A” thru “Z”- All upper case letters.
- “0” thru “9”- All decimal digits.
- Space (i.e., ASCII code 0x20).
- Punctuation marks shown in brackets [. , ! ? - ‘ ’ “ ” / ()]
- Special characters shown in brackets [# & * + < >]

2. DMS Configuration

As defined in NTCIP 1203.

3. MULTI Configuration

As defined in NTCIP 1203. The following list indicates the modified object requirements for this conformance group.

Table 8: Modified Object Ranges for the MULTI Configuration Conformance Group

Object	Reference	Project Requirement
DefaultBackgroundColor	NTCIP 1203 Clause 2.5.1.1.1.1	The DMS supports the following background colors: black
DefaultForegroundColor	NTCIP 1203 Clause 2.5.1.1.1.2	The DMS supports the following foreground colors: amber
DefaultJustificationLine	NTCIP 1203 Clause 2.5.1.1.1.6	The DMS supports the following forms of line justification: left center right full
defaultJustificationPage	NTCIP 1203 Clause 2.5.1.1.1.7	The DMS supports the following forms of page justification: top middle bottom
defaultPageOnTime	NTCIP 1203 Clause 2.5.1.1.1.8	The DMS supports the full range of these objects with step sizes no larger than 0.5

			seconds
defaultPageOffTime	NTCIP 1203 2.5.1.1.1.9	Clause	The DMS supports the full range of these objects with step sizes no larger than 0.5 seconds
defaultCharacterSet	NTCIP 1203 2.5.1.1.1.10	Clause	The DMS supports the following character sets: eightBit

- 4. **Default Message Control** as defined in NTCIP 1203
- 5. **Pixel Service Control** as defined in NTCIP 1203
- 6. **MULTI Error Control** as defined in NTCIP 1203
- 7. **Illumination/Brightness Control**

As defined in NTCIP 1203. The following list indicates the modified object requirements for this conformance group.

Table 9: Modified Object Ranges for the Illumination/Brightness Control Conformance Group

Object	Reference	Project Requirement
dmsIllumControl	NTCIP 1203 2.8.1.1.1.1	Clause The DMS supports the following illumination control modes: photocell timer manual
dmsIllumNumBrightLevels	NTCIP 1203 2.8.1.1.1.4	Clause At least 16

- 8. **Auxiliary I/O**
- 9. **Scheduling**

As defined in NTCIP 1203. The following list indicates the modified object requirements for this conformance group.

Table 10: Modified Object Ranges for the Scheduling Conformance Group

Object	Reference	Project Requirement
NumActionTableEntries	NTCIP 1203 2.9.1.1.1.1	Clause At least 21

- 10. Sign Status** as defined in NTCIP 1203
- 11. Status Error** as defined in NTCIP 1203
- 12. Pixel Error Status** as defined in NTCIP 1203
- 13. Fan Error Status** as defined in NTCIP 1203
- 14. Power Status** as defined in NTCIP 1203
- 15. Temperature Status** as defined in NTCIP 1203

Install necessary hardware for the support of items q, r, and s above.

Table 11: Some Optional Object Requirements

Object	Reference	Project Requirement
DefaultFlashOn	NTCIP 1203 Clause 2.5.1.1.1.3	The DMS supports the full range of these objects with step sizes no larger than 0.5 seconds
DefaultFlashOff	NTCIP 1203 Clause 2.5.1.1.1.4	The DMS supports the full range of these objects with step sizes no larger than 0.5 seconds
DmsMultiOtherErrorDescription	NTCIP 1203 Clause 2.7.1.1.1.20	If the vendor implements any vendor-specific MULTI tags, the DMS shall provide meaningful error messages within this object whenever one of these tags generates an error.

16. Documentation

Supply software with full documentation, including a CD-ROM containing ASCII versions of the following MIB files in Abstract Syntax Notation 1 (ASN.1) format:

- The relevant version of each official standard MIB Module referenced by the device functionality.
- If the device does not support the full range of any given object within a Standard MIB Module, a manufacturer specific version of the official Standard MIB Module with the supported range indicated in ASN.1 format in the SYNTAX and/or DESCRIPTION fields of the associated OBJECT TYPE macro. Name this file identical to the standard MIB Module, except that it will have the extension ".man".

- A MIB Module in ASN.1 format containing any and all manufacturer-specific objects supported by the device with accurate and meaningful DESCRIPTION fields and supported ranges indicated in the SYNTAX field of the OBJECT-TYPE macros.
- A MIB containing any other objects supported by the device.

Allow the use of any and all of this documentation by any party authorized by the Department for systems integration purposes at any time initially or in the future, regardless of what parties are involved in the systems integration effort.

17. NTCIP Acceptance Testing

Test the NTCIP requirements outlined above by a third party testing firm. Submit to the Engineer for approval a portfolio of the selected firm. Include the name, address, and a history of the selected firm in performing NTCIP testing along with references. Also provide a contact person's name and phone number. Submit detailed NTCIP testing plans and procedures, including a list of hardware and software, to the Engineer for review and approval 10 days in advance of a scheduled testing date. Develop test documents based on the NTCIP requirements of these Project Special Provisions. The acceptance test will use the NTCIP Exerciser, and/or other authorized testing tools and will follow the guidelines established in the ENTERPRISE Test Procedures. Conduct the test in North Carolina on the installed system in the presence of the Engineer. Document and certify the results of the test by the firm conducting the test and submit the Engineer for review and approval. In case of failures, remedy the problem and have the firm retest in North Carolina. Continue process until all failures are resolved. The Department reserves the right to enhance these tests as deemed appropriate to ensure device compliance.

DMS TESTING REQUIREMENTS

A) GENERAL TEST PROCEDURE

Test the DMS system in a series of design approval and functional tests. The results of each test must meet the specified requirements. These tests should not damage the equipment. The Engineer will reject equipment that fails to fulfill the requirements of any test. Resubmit rejected equipment after correcting non-conformities and re-testing; completely document all diagnoses and corrective actions. Modify all equipment furnished under this contract, without additional cost to the North Carolina Department of Transportation, to incorporate all design changes necessary to pass the required tests.

Provide 4 copies of all test procedures and requirements to the Engineer for review and approval at least 30 days prior to the testing start date.

Only use approved procedures for the tests. Include the following in the test procedures:

- A step-by-step outline of the test sequence, showing a test of every function of the equipment or system tested
- A description of the expected nominal operation, output, and test results, and the pass / fail criteria
- An estimate of the test duration and a proposed test schedule

- A data form to record all data and quantitative results obtained during the test
- A description of any special equipment, setup, manpower, or conditions required by the test

Provide all necessary test equipment and technical support. Use test equipment calibrated to National Institute of Standards and Technology (NIST) standards. Provide calibration documentation upon request.

Conform to these testing requirements and the requirements of these specifications. The Engineer will reject all equipment not tested according to these requirements. It is the Contractor's responsibility to ensure the DMS system functions properly even after the Engineer accepts the DMS test results.

Provide 4 copies of the quantitative test results and data forms containing all data taken, highlighting any non-conforming results and remedies taken, to the Engineer for approval. An authorized representative of the manufacturer must sign the test results and data forms.

B) DESIGN APPROVAL TESTS

Design Approval Tests are applicable to DMS systems not currently on the QPL.

The Design Approval Tests consists of all tests described in Section 2.2 "DMS Equipment Tests" of NEMA TS 4-2005 (Hardware Standards for Dynamic Message Signs with NTCIP Requirements). Perform all tests and submit certified results for review and approval.

PROTOTYPE – Manufacture a prototype DMS and controller of the type and size described in the Project Special Provisions. In the presence of the Engineer, test the prototype according to the Design Approval and Operational Tests. When all corrections and changes (if any) have been made, the Department may accept the prototype DMS and controller as the physical and functional standard for the system furnished under this contract. You may use the prototype units on this project if, after inspection and rework (if necessary), they meet all physical and functional specifications. In the case of standard product line equipment, if the Contractor can provide test results certified by an independent testing facility as evidence of prior completion of successful design approval tests, then the Engineer may choose to waive these tests.

In each Design Approval Test, successfully perform the Functional Tests described below. Apply the extreme conditions to all associated equipment unless stated otherwise in these Project Special Provisions.

1. OPERATIONAL FIELD TEST (ON-SITE COMMISSIONING)

Conduct an Operational Field Test of the DMS system installed on the project to exercise the normal operational functions of the equipment. The Operational Field Test will consist of the following tests as a minimum.

2. Physical Examination

Examine each piece of equipment to verify that the materials, design, construction, markings, and workmanship comply with the mechanical, dimensional, and assemblies requirements of these Project Special Provisions.

Perform the following tests as a minimum:

Verify that all surfaces are free of dents, scratches, weld burns, or abrasions.
Round sharp edges and corners.

Verify bend radius of cables is not excessive or could potentially cause damage.

Verify all modules, lamps, and components are properly secured.

Verify that there are no exposed live terminals.

3. Continuity Tests

Check the wiring to assure it conforms to the requirements of these Project Special Provisions.

4. Functional Tests

Perform the following functional tests:

Start-up and operate the DMS locally using a laptop computer.

Use automatic (photo-electric sensor controlled) DMS Control Software to switch between “dim”, “normal”, and “bright” light levels.

Operate the DMS with all display elements flashing continuously for 10 minutes at the maximum flash rate.

Exercise the DMS by displaying static messages, flashing messages, and alternating static and flashing message sequences.

Automatic poll the DMS by the Control Software at various intervals and verify the data received by Control Software from DMS.

Download and edit messages using Control Software.

Execute status request on the DMS controller.

Observe normal operations during uploading and downloading messages.

Input and select messages from the sign controller’s local user interface.

Test sequence activation at chosen intervals.

Display and verify all stored messages.

Verify resumption of standard operation upon interruption of electrical power.

Demonstrate detected failures and response functions.

Demonstrate proper operation of the Failure Log.

Set controller clock using the Control Software.

Execute system shutdown using the Control Software and local user interface.

Verify detection of a power failure in the DMS enclosure and the report feature of the failure to the Control Software.

Approval of Operational Field Test results does not relieve the Contractor to conform to the requirements in these Project Special Provisions. If the DMS system does not pass

these tests, document a correction or substitute a new unit as approved by the Engineer. Re-test the system until it passes all requirements.

30-DAY OBSERVATION PERIOD

The 30-Day Observation Period is part of work to be completed by the project completion date.

Upon successful completion of all project work, the component tests, the System Test, and the correction of all deficiencies, including minor construction items, the 30-day Observation Period may commence. This observation consists of a 30-day period of normal, day-to-day operations of the new field equipment in operation with the new central equipment without any failures. The purpose of this period is to ensure that all components of the system function in accordance with the DMS drawings and these Project Special Provisions.

Respond to system or component failures (or reported failures) that occur during the 30-day Observation Period within twenty-four (24) hours. Correct said failures within forty-eight (48) hours. Any failure that affects a major system component as defined below for more than forty-eight (48) hours will suspend the timing of the 30-day Observation Period beginning at the time when the failure occurred. After the cause of such failures has been corrected, timing of the 30-day Observation Period will resume. System or component failures that necessitate a redesign of any component or failure in any of the major system components exceeding a total of three (3) occurrences will terminate the 30-day Observation Period and cause the 30-day Observation Period to be restarted from day zero when the redesigned components have been installed and/or the failures corrected. The major system components are:

- DMS Field Controller
- DMS Display Module
- DMS Workstation software

DMS ASSEMBLY

A) DESCRIPTION

This section includes all design, fabrication, furnishing, and erection of the DMS assembly, maintenance walkway for access to the DMS inspection door and attachment of the DMS enclosures to the structure in accordance with the requirements of these Project Special Provisions. Fabricate the supporting DMS assemblies from tubular steel. Fabricate the supporting DMS assembly from tubular steel. Fabricate a pedestal type DMS assembly.

Provide the pedestal structure with a minimum of 25 feet clearance from the high point of the road to the bottom of the DMS enclosure. The DMS assembly must allow for field adjustment (horizontal & vertical tilting) of the DMS enclosure to ensure optimum legibility from all travel lanes.

Design the DMS assembly including footings. Submit design computations and shop drawings to the Engineer for acceptance. A Professional Engineer that is registered in the

state of North Carolina will prepare such computations and drawings. These must bear his signature, seal, and date of acceptance.

The provisions of Section 900 of the Standard Specifications apply to all work covered by this section.

B) MATERIAL

Use materials that meet the following requirements of the Standard Specifications:

Structural Steel	Section 1072
Overhead Structures	Section 1096
Signing Materials	Section 1092
Organic-Zinc Repair Paint	Article 1080-9
Reinforcing Steel	Sub-article 1070
Direct Tension Indicators	Sections 440 and 1072

C) CONSTRUCTION METHODS

1. General

Fabricate the DMS assembly in accordance with the details shown in the approved shop drawings and the requirements of these Project Special Provisions.

No welding, cutting, or drilling in any manner will be permitted in the field, unless approved by the Engineer.

Drill bolt holes and slots to finished size. Holes may also be punched to finished size, provided the diameter of the punched holes are at least twice the thickness of the metal being punched. Flame cutting of bolt holes and slots will not be permitted.

Use two coats of a zinc-rich paint to touch up minor scars on all galvanized materials.

2. Shop Drawing

Submit to the Engineer for approval a complete design for the DMS assembly, including footings, DMS assembly hardware, brackets for supporting the DMS and the maintenance walkway. Base the design on the line drawings and correct wind speed in accordance with the latest edition of AASHTO "Standard Specifications for Structural Supports for Highway Signs, Luminaries and Traffic Signals."

The manufacturer of the DMS assembly must ensure that design of the assembly is compatible with the DMSs for mounting and attachment.

Submit six copies of complete detailed shop drawings and one copy of the design computations for the DMS assembly to the Engineer for approval prior to fabrication. Show in the shop drawings complete design and fabrication details including foundations, provisions for attaching the DMS and maintenance walkway to supporting structures, applicable material specifications, and any other information necessary for procuring and replacing any part of the complete DMS assembly.

Allow a minimum of 15 working days for shop drawing approval after the Engineer receives them. If revised drawings are necessary, allow appropriate additional time for review and approval of final shop drawings.

Approval of shop drawings by the Engineer will not relieve the Contractor of his responsibility for the correctness of drawings, or for the fit of all shop and field connections and anchors.

DESIGN AND FABRICATION

A) Dynamic Message Sign Assembly

Fabricate the DMS assembly in accordance with the details shown in the approved shop drawings and with the requirements of these Project Special Provisions.

Determine the actual dimensions of the DMS assembly from field measurements and DMS enclosure dimensions. Furnish plans to reflect those dimensions. Attach the DMS assembly to the concrete foundations with galvanized anchor bolts. Furnish anchor bolts with galvanized nuts, flat washers and lock washers. Provide anchor bolts that have an anchor plate with a nut at the end embedded in concrete.

Fabricate the attachment hardware for mounting the DMS to the assembly in a manner that will ensure easy removal the DMS.

B) Access Platform

Provide an access platform, a minimum of three feet wide with open skid-resistant surface and safety railing, on the DMS assembly for access to the DMS inspection door. Provide platforms with fixed safety railings along both sides from the beginning of the platform to the inspection door.

Connect the platform sections rigidly where sections join to avoid an uneven walking surface.

Install a 4"x 4" safety angle parallel to and along both sides of the platform and extend it the entire length of the platform. Design the safety angle to withstand loading equivalent to the platform.

C) DMS Access Ladder

Provide a fixed ladder, of the same material as the assembly, leading to the access platform. Equip the ladder with a security cover (ladder guard) and lock to prohibit access by unauthorized persons. Start the first ladder rung no more than 18 inches above finished ground and end it at the access platform. Design the rungs on 12-inch center to center typical spacing. Attach the security cover approximately 6 feet above the finished ground. Design the ladder and security cover as a permanent part of the DMS assembly and include complete design details in the DMS assembly shop drawings. Fabricate the ladder and cover to meet all OSHA requirements and applicable state and local codes, including but not limited to providing a ladder cage. Attached the bottom of the ladder to a concrete pad a minimum of 4 inches deep, 24 inches wide, and 36 inches long.

D) Anchor Rod Nut Tightening Requirements for Metal Poles

Reference the Overhead Sign Support Project Special Provision for anchor rod nut tightening requirements for metal poles.

DMS FOUNDATION

Reference the Overhead Sign Foundation Project Special Provision found in this RFP.

DMS DIRECT TENSION INDICATORS**A) GENERAL**

Use direct tension indicators on all ASTM A325 high strength bolt connections in DMS structures.

Provide direct tension indicators that conform to these Project Special Provisions, the requirements of ASTM F959 and the manufacturer's recommendations.

B) MATERIAL REQUIREMENTS

Use direct tension indicators whose material, manufacturing process, performance requirements, workmanship and certification requirements conform to the requirements of ASTM F959.

For Type 3 high strength bolts, use direct tension indicators mechanically galvanized to ASTM B695 Class 50, then with 1 mil of baked epoxy applied.

For plain Type 1 high-strength bolts, use direct tension indicators that are plain or mechanically galvanized to ASTM B695 Class 50.

For galvanized Type 1 high strength bolts, use direct tension indicators that are mechanically galvanized to ASTM B695 Class 50 only.

C) TEST DOCUMENTS

Furnish the Engineer with a copy of the manufacturer's test report for each lot of direct tension indicators used in the project. The manufacturer must perform these tests according to the requirements of ASTM F959. Include in each test report the lot number of the indicators, manufacturer's name, tension load when indicators were tested, gap clearance, nominal size, coating thickness, date tested, and name and location of the company that performed the tests.

Furnish the Engineer with a copy of the manufacturer's instructions for installing the direct tension indicators before installation begins along with at least 1 metal feeler gauge for each 50 direct tension indicators shipped.

Use only direct tension indicators whose container lot numbers match the lot numbers on the test documents.

D) REQUIRED TEST SAMPLES

Furnish the Engineer with three samples of load indicating washers from each lot number, size and type for departmental tests along with two of the metal feeler gages required for performing the tests.

E) CONSTRUCTION METHODS**1. Installation**

Install the direct tension indicators in strict compliance with the manufacturer's written instructions.

Install the direct tension indicator under the bolt head normally. If it is necessary to install the direct tension indicator under the nut, or if the bolt head must be turned, install additional hardened washers in accordance with the manufacturer's instructions.

Have a tension-indicating device on the project for determining the tension imposed on a fastener when the protrusions on direct tension indicator have been properly compressed.

Test three samples from each lot of direct tension indicators in the presence of the Engineer. Achieve a minimum bolt tension 5 percent greater than that required by Table 440-1 in Article 440-10 of the Standard Specifications. Do not substitute direct tension indicators for the hardened steel washers required with short slotted or oversized holes, but you may use them in conjunction with them.

Initially install the direct tension indicators to a snug tight condition as specified in Section 440-10 Paragraph (C) (3) of the Standard Specifications. After the initial tightening, fully tighten the fasteners, as recommended by the manufacturer of the direct tension indicators, beginning at the most rigid part of the joint and continuing toward its free edges.

Use a wrench to tighten fasteners containing direct tension indicators of the type and capacity recommended by the manufacturer and which is clean and lubricated. Use an air supply and hoses that are in good condition and provide air pressure of at least 100 psi at the wrench.

Perform any heating of structural steel required for corrections in the vicinity of fasteners before direct tension indicators are installed.

2. Inspection

The Engineer will inspect for correct tightening of bolts by inserting a 0.005 inch thickness feeler gauge into the openings between adjacent flattened protrusions of the direct tension indicator. The tension is correct when the number of spaces the gage can not enter is equal to or greater than the value shown in the table below.

<u>Number of Spaces in Washer</u>	<u>Number of Spaces Gage is Refused</u>
4	2
5	3
6	3
7	4

The gage must not be able to enter any spaces when the direct tension indicator is used under the turned element.

Do not tighten bolts to a no visible gap condition. Replace bolts that have a direct tension indicator with no visible gap and tighten the bolts with a direct tension indicator.

The Engineer will inspect at least 10 percent, but no less than 2, of the bolts in each connection, using the metal feeler gages provided by the Contractor.

Ensure that the part of the fastener being restrained from turning does not rotate during the tightening process, thereby abrading away a portion of the direct tension indicator protrusions.

Ensure that none of the direct tension indicator protrusions are accidentally partially flattened before installing in the structural steel joints.

Do not reuse direct tension indicators. If it becomes necessary to loosen a bolt previously tensioned, discard and replace the direct tension indicator.

DOCUMENTS AND SUBMITTALS

A) GENERAL

The submittals listed below complement requirements stated throughout these Project Special Provisions and do not replace them.

Provide all drawings on 22" X 34" sheet of paper unless approved by the Engineer otherwise. The drawing must fill the entire sheet of paper excluding a 2" border all around.

Allow 30 days for all documentation and submittal reviews unless otherwise stated in these Project Special Provisions. Supplement each drawing by catalog cut sheets and parts list. Provide parts list in the following format:

•

Part ID	Source	Part number	Alternate source	Alternate Part number	Description

B) DRAWINGS AND DOCUMENTS' CERTIFICATION

Provide the following drawings, documents, plans, and calculations approved by a Professional Engineer registered in the state of North Carolina that bears his/her signature, seal, and date of acceptance:

- Plans for the DMS enclosure, mounting description, and shop drawings.
- Plans for pedestal mounted assemblies, footings, design computations and shop drawings.
- Electrical power distribution drawings and power consumption calculations.

C) MECHANICAL

This set of submittals includes, but is not limited to, material specifications, catalog cut sheets, parts list, and fabrication drawings for DMS controller cabinet(s), DMS enclosure, character assemblies, DMS overhead assemblies, DMS to DMS overhead assemblies mounting, and etc. Engineering calculations must accompany drawings as needed and applicable.

D) ELECTRICAL

This set of submittals includes, but is not limited to, material specifications, catalog cut sheets, parts list, and wiring diagrams within the DMS controller cabinet, DMS enclosure, DMS controller cabinet/enclosure, service entrance cabinet/panels, and etc. This set of submittals also includes power consumption calculations, wire and conduit size calculations,

voltage drop calculation, and etc. The DMS electrical system: wires, conduits, breakers, panel-boards, and etc. must meet the latest edition of NEC requirements.

E) Electronics

This set of submittals includes, but is not limited to, material specifications, catalog cut sheets, parts list, and schematic diagrams for all electronics assemblies and sub-assemblies used in the system.

F) BLOCK DIAGRAMS

Provide block diagrams for the following:

- DMS System
- DMS Controller Cabinet
- DMS Enclosure
- DMS Controller
- DMS Display Boards
- DMS Driver Board(s)
- DMS Lighting Control Board(s)
- Interface Board(s)
- And other system's boards/assemblies that help in understanding, troubleshooting, and repairing the system and/or system's components.

G) LEDs

This set of submittals includes LED data/specification sheets and the LED selection procedure as required elsewhere in these Project Special Provisions.

H) BENCH REPAIR DOCUMENTATION:

After approval of any equipment or equipment component parts and prior to installation of the equipment, supply all schematics drawings, board layout information, equipment manuals, software, and firmware required to perform bench repair to the component level and testing of electronic equipment and equipment circuit boards. Failure to supply the documentation required by this Section will be grounds for rejection of the submitted item. Provide schematic drawings as well as the board layout drawings that identify all components in the equipment or circuit board including but not limited to all digital and analog integrated circuits devices (ICs), all discrete electronic components, transformers, relays, and other electronic devices and components used in the circuits. Provide schematic drawings that show pin to pin interconnection between components. Provide a complete parts list for each circuit board's components. Provide a copy of all software required to operate any equipment or circuit boards for the purposes of test or system software to test operation of equipment used as a system component.

I) PROPRIETARY PARTS

Provide a list of all proprietary, non-warranty electronic component parts, along with its associated cost, at which the vendor will supply for a two year period after final project acceptance. Failure to supply this required proprietary part and price information may be

grounds for rejection of the submitted item due to incomplete information. A part is considered to be a proprietary part if it is designed and manufactured exclusively for a specific application and is not commercially available for sale to the general public. In addition, any item that is sole source (e.g. available only from the vendor or from a single known manufacturer) is considered to be proprietary and should be identified along with the sole source. Identify and quote a price for parts that are no longer being manufactured and identify the item as one that is no longer manufactured.

J) USE BY NCDOT AND PROTECTION OF MANUFACTURER'S PROPRIETARY INFORMATION

NCDOT Traffic Electronics Center electronics technicians will use the above documentation (schematics, drawings, software, firmware, manuals, etc.) exclusively for the following purposes: diagnosing and performing repairs on malfunctioning equipment, equipment circuit boards, and malfunctioning systems; operational test of repaired equipment, circuit boards, systems; and performing authorized upgrades to equipment, circuit boards, and software supplied under this contract. NCDOT Traffic Electronics Center electronics technicians will not use or copy devices or software for any purpose other than diagnosis, repair, and testing or to perform authorized firmware or software upgrades.

Upon notification by the manufacturer, the Department agrees not to divulge any proprietary or otherwise confidential information contained in the above required documentation. The Transportation Mobility and Safety Division of NCDOT agrees to protect and secure any proprietary documentation identified by the manufacturer as proprietary or confidential. Upon request by the manufacturer, Transportation Mobility and Safety Division of NCDOT agrees to sign a binding non-disclosure agreement with the manufacturer or other business that is providing documentation it considers proprietary or otherwise confidential.

GENERAL

The State will not be bound by oral explanations or instructions given at any time during the bidding process or after award. Only information that is received in response to this RFP will be evaluated; reference to information previously submitted will not suffice as a response to this solicitation.

NO CONTACT CLAUSE

To ensure that information is distributed equitably to all short-listed Design-Build Teams, all questions and requests for information shall be directed to the State Contract Officer through the Design-Build e-mail address. This precludes any Design-Build Team Member, or representative, from contacting representatives of the Department, other State Agencies or Federal Agencies either by phone, e-mail or in person concerning the Design-Build Project.

USE OF TERMS

Throughout this RFP and all manuals, documents and standards referred to in the RFP the terms Contractor, Bidder, Design-Builder, Design-Build Team, Team, Firm, Company, and Proposer are synonymous.

Throughout this RFP and all manuals, documents and standards referred to in the RFP, the terms NCDOT, Department, Engineer, and State are synonymous.

Throughout this RFP and all documents referred to in the RFP, references to the Technical Proposal include all Technical Proposal supplemental information that may be submitted in response to a Best and Final Offer RFP.

DESIGN REFERENCES

Design references developed and published by NCDOT and those developed and published by other agencies and adopted for use by NCDOT which are to be used in the design of this project may be obtained by contacting Contract Standards and Development within the Technical Services Division. Standard prices for materials, which the Department normally sells for a fee, will be in effect. The Design-Build Team shall be responsible for designing in accordance with the applicable documents and current revisions and supplements thereto.

REVIEW OF SUBMITTALS

Major design milestones and required design submittals shall be identified as activities on a CPM, bar chart, or other scheduling tool. This schedule shall be submitted to the Transportation Program Management Director and Resident Engineer concurrently with the first design submittal, or within 30 days of the contract award, whichever is earlier. The schedule shall be revised and resubmitted as design milestones change or as directed by the Transportation Program Management Director. Submittals will be reviewed within 10 working days (15 days for temporary structures, overhead sign assemblies, MSE walls, FEMA compliance documents, and temporary shoring) from the date of receipt by NCDOT unless otherwise stipulated in the scope of work. All submittals shall be prepared and submitted in accordance with the "*Design-Build*

Submittal Guidelines”, which by reference are incorporated and made a part of this contract. All submittals shall be made simultaneously to the Transportation Program Management Director and the Resident Engineer. The Department will not accept subsequent submittals until prior submittal reviews have been completed for that item. The Design-Build Team shall inform the Transportation Program Management Director in writing of any proposed changes to the NCDOT preliminary designs, Technical Proposal and / or previously reviewed submittals and obtain approval prior to incorporation. The Design-Build Team shall prioritize submittals in the event that multiple submittals are made based on the current schedule. All submittals shall include pertinent Special Provisions. No work shall be performed prior to Department review of the design submittals.

OVERVIEW

The Design-Build Project I-2304AD is the widening of I-85 from North of NC 150 to just North of I-85 Business in Davidson County. The proposed improvements consist of approximately 3.6 miles of an eight-lane divided facility with full control of access.

Project services shall include, but are not limited to:

- **Design Services** – completion of construction plans, including Record Drawings
- **Construction Services** – necessary to build and ensure workmanship of the designed facility
- **Permit Modification** - development of documents for required permit modifications, if any
- **Right of Way** – acquisition of additional right of way necessary to construct project, if any
 - ✓ The EA was approved on November 6, 2000
 - ✓ The FONSI was approved on December 15, 2003
 - ✓ The Project Environmental Consultation (Right of Way and Construction Phase) was approved on May 15, 2009
 - ✓ A second Project Environmental Consultation (Right of Way and Construction Phase) was approved in March 2010

Construction Engineering Inspection will be provided by the NCDOT Division personnel.

GENERAL SCOPE

The scope of work for this project includes design, construction and management of the project. The design work includes all aspects to construct an eight-lane freeway. The designs shall meet all appropriate latest versions of *AASHTO Policy on Geometric Design of Highways and Streets*, *AASHTO LRFD Bridge Design Specifications*, *Manual of Uniform Traffic Control Devices*, and all NCDOT design policies that are current as of the Technical and Price Proposal submission date or the Best and Final Offer submission date.

Construction shall include, but not be limited to, all necessary clearing, grading, roadway, drainage, structures, utility coordination and relocation, and erosion and sediment control work items for the proposed eight-lane facility and installation of the control of access fence. Construction engineering and management shall be the responsibility of the Design-Build Team.

Construction shall comply with 2006 *NCDOT Standard Specifications for Roads and Structures* and any special provisions.

Areas of work required for this project shall include, but are not limited to the following items:

- Roadway Design
- Structure Design
- Hydraulic Design
- Permit Modification, as necessary
- Subgrade Stabilization
- Foundation Design for Structures and Roadway
- Erosion and Sediment Control Design and Implementation
- R/W Utilities, Conflicts and / or Construction, as necessary
- Traffic Control and Pavement Marking Design
- Sign Design (including one DMS)
- Traffic Management
- Construction
- Project Management
- Design and Construction Management
- Construction Surveying
- Location and Surveys
- Lighting (Construction Only)
- Right of Way Acquisition, as necessary
- Public Involvement

All designs shall be in Microstation format using Geopak software (current version used by the Department).

DESIGN AND CONSTRUCTION PERFORMED BY DESIGN-BUILD TEAM

The design work consists of the preparation of all construction documents for constructing approximately 3.6 miles of an eight-lane divided facility as outlined in the Scope of Work section of this RFP. The Design-Build Team shall prepare final designs, construction drawings and special provisions.

The Design-Build Team shall acknowledge that project documents furnished by the Department are preliminary and provided solely to assist the Design-Build Team in the development of the project design. The Design-Build Team shall be fully and totally responsible for the accuracy and completeness of all work performed under this contract and shall save the State harmless and shall be fully liable for any additional costs and all claims against the State which may arise due to errors, omissions and negligence of the Design-Build Team in performing the work required by this contract.

There shall be no assignment, subletting or transfer of the interest of the Design-Build Team in any of the work covered by the Contract without the written consent of the State, except that the Design-Build Team may, with prior written notification of such action to the State, sublet property searches and related services without further approval of the State.

The Design-Build Team shall certify all plans, specifications, estimates and engineering data furnished by the Team.

All work by the Design-Build Team shall be performed in a manner satisfactory to the State and in accordance with the established customs, practices, and procedures of the North Carolina Department of Transportation, and in conformity with the standards adopted by the American Association of State Highway Transportation Officials, and approved by the U.S. Secretary of Transportation as provided in Title 23, U.S. Code, Section 109 (b). The decision of the Engineer / State / Department shall control in all questions regarding location, type of design, dimension of design, and similar questions.

Alternate designs, details, or construction practices (such as those employed by other states, but not standard practice in NC) are subject to Department review and will be evaluated on a case by case basis.

The Design-Build Team shall not change team members, subconsultants or subcontractors identified in the Statement of Qualifications (SOQ) or Technical Proposal without written consent of the Engineer or the State Contract Officer. In addition, subconsultants and subcontractors not identified in the SOQ or Technical Proposal shall not perform any work without written consent by the Engineer. Individual offices of the Design-Build Team not identified in the Statement of Qualifications or the Technical Proposal submitted shall not perform any work without written consent by the Engineer. Failure to comply with this requirement may be justification for removing the Team from further consideration for this project and disqualification from submitting on future Design-Build Projects.

All firms shall be prequalified by the Department for the work they are to perform. Joint Ventures, LLCs or any legal structure that are different than the existing prequalification status must be prequalified prior to the Technical and Price Proposal submittal deadline. Subcontractors need only be prequalified prior to performing the work. Design firms should be prequalified prior to the Technical and Price Proposal submittal deadline. If not prequalified at the time of the Technical and Price Proposal submittal deadline, the prime contractor shall be solely responsible for either (1) ensuring that the design firm is prequalified prior to its first design submittal or (2) replacing that firm with a prequalified firm. Design firms and Natural Systems firms are prequalified by the particular office performing the work. If the work is to be performed by an office other than the one that is prequalified, that office shall be prequalified prior to any design submittals.

ETHICS POLICY

Employees employed by the Design-Build Team or employees employed by any subconsultant for the Design-Build Team to provide services for this project shall comply with the Department's ethics policy. Failure to comply with the ethics policy will result in the employee's removal from the project and may result in removal of the Company from the Department's appropriate prequalified list.

APPROVAL OF PERSONNEL

The Department will have the right to approve or reject any personnel, assigned to a project by the Design-Build Team.

The Design-Build Team or any subcontractor for the Design-Build Team which are employed to provide services for this project shall not discuss employment opportunities or engage the services of any person or persons, now in the employment of the State during the time of this contract, without written consent of the State.

In the event of engagement, the Design-Build Team or their subcontractors shall restrict such person or persons from working on any of the Design-Build Team's contracted projects in which the person or persons were "formerly involved" while employed by the State. The restriction period shall be for the duration of the contracted project with which the person was involved. *Former Involvement* shall be defined as active participation in any of the following activities:

- Drafting the contract
- Defining the contract scope of the contract
- Design-Build Team selection
- Negotiation of the contract cost (including calculating manhours or fees); and
- Contract administration

An exception to these terms may be granted when recommended by the Secretary and approved by the Board of Transportation.

Failure to comply with the terms stated above in this section shall be grounds for termination of this contract and / or not being considered for selection of work on future contracts for a period of one year.

SUBMITTAL OF TECHNICAL AND PRICE PROPOSALS

Technical and / or Price Proposals that do not adhere to all the requirements noted below may be considered non-responsive and may result in the Department not considering the Design-Build Team for award of the contract or reading their Price Proposal publicly.

GENERAL

Technical and Price Proposals will be accepted until **4:00 p.m. Local Time on Wednesday, December 22, 2010**, at the office of the State Contract Officer:

Mr. Randy A. Garris, PE
Contract Standards and Development
1020 Birch Ridge Drive
Century Center Complex - Building B
Raleigh, NC 27610

No Proposals will be accepted after the time specified.

Proposals shall be submitted in 2 separate, sealed parcels containing the Technical Proposal in one and the Price Proposal in the other parcel.

TECHNICAL PROPOSAL

Technical Proposals shall be submitted in a sealed package. The outer wrapping shall clearly indicate the following information:

Technical Proposal
Submitted By: (Design-Build Team's Name)
Contract Number C 202382
TIP Number I-2304AD
Davidson County
I-85 from north of NC 150 to just north of I-85 Business

Technical Proposal Requirements

12 Copies
8 ½ inch by 11 inch pages
Printed on one side only
Double-spaced
Font size 12

A minimum font size 10 is permissible within embedded tables, charts and graphics.
No more than 50 pages, excluding the introductory letter to Mr. Randy Garris, P.E. (two-page maximum length) and the 11 inch by 17 inch appropriate plan sheets
24 x 36 inch fold out sheets will only be allowed to present interchange plans

Key Project Team members, identified in the Statement of Qualifications, shall not be modified in the Technical Proposal without written approval of the Department. Any such request should be sent to the attention of Mr. Randy Garris, PE, at the address below:

NCDOT- Contract Standards and Development
Century Center Complex - Building B
1020 Birch Ridge Drive
Raleigh, NC 27610

PRICE PROPOSAL

Price Proposals shall be submitted in a sealed package. The outer wrapping will clearly indicate the following information:

Price Proposal
Submitted By: (Design-Build Team's Name)
Contract Number C 202382
TIP Number I-2304AD
Davidson County
I-85 from north of NC 150 to just north of I-85 Business

The Price Proposal shall be submitted by returning the Request for Proposals with the item sheets completed, and all required signatures and bonds. Failure to execute the required documents may render the proposal non-responsive.

EVALUATIONS

Decisions based on cost alone will not establish the design standards for the project. Technical Proposals shall address the technical elements of the design and construction of the project. The Technical Review Committee will consider the understanding of the project, the anticipated problems and the solutions to those problems, in addition to other evaluation criteria identified herein.

The Design-Build Team's Technical Proposal shall be developed using narratives, tables, charts, plots, drawings and sketches as appropriate. The purpose of the Technical Proposal is to document the firm's understanding of the project, demonstrate the Team's capabilities to complete the project, document their selection of appropriate design criteria, and state their approach and schedule for completing all design and construction activities.

The review of design plans by the Department is not intended to reflect a reviewer's personal preferences, but rather to ensure that all contract requirements are met, sound engineering judgment is exercised by the Design-Build Team, and that the Design-Build Team adheres to all referenced documents, including but not limited to, design standards, codes, memos and manuals. As such, the award of the Design-Build contract does not in any way imply that the NCDOT accepts the details of the Technical Proposal submitted by the Design-Build Team.

The Technical Proposal will be evaluated in each of the following major categories:

EVALUATION FACTORS	POINTS
1. Management	13
2. Responsiveness to Request for Proposal	20
3. Long Term Maintenance	5
4. Schedule and Milestones	30
5. Innovation	4
6. Maintenance of Traffic and Safety Plan	25
7. Oral Interview	3

TECHNICAL PROPOSAL EVALUATION CRITERIA

1. Management – 13 points

Design-Build Team Management

- Describe the Design-Build Team's concept of design management. The proposal shall identify key positions and subordinate organizational units.
- Describe the plan for the coordination of civil / structural, utilities, traffic maintenance, constructability and environmental responsibility.

- Provide a narrative description of the proposed location of the design office(s) and their respective responsibilities.
- Describe how the designs developed by different firms and offices will be integrated.
- Describe how design personnel will interface with the construction personnel.
- Describe the overall strengths of the Design Team and their ability to fulfill the design requirements of this project.
- List projects, including description and similarity to the subject project, that the Team's designer(s) have developed Traffic Control Plans.
- Identify a Traffic Control Supervisor and briefly describe their qualifications for this role.

Quality Management

- Describe how the Design-Build Team will comply with the quality control requirements for both design and construction. Specifically, include a narrative describing the Design-Build Team's understanding of the Department's construction quality control philosophy for this project and how the Design-Build Team will implement it.
- The Design-Build Team should detail the number of inspectors they expect the Department to furnish, during various phases, to allow satisfactory progress of project construction.
- Describe any significant quality control issues experienced on NCDOT projects in the last ten years and how those issues will be addressed for this project.
- The narrative shall include both design and construction activities.

Construction Management

- Describe the Design-Build Team's concept of the project construction management organization and how it interrelates with the other elements of the Design-Build Team's organization for the project.
- Provide a brief narrative description of the Design-Build Team's proposed plan for performing construction on the project. This description shall include at least the following:
 - A construction organization chart for the project, showing the relationships between functions shown on the chart and the functional relationships with subcontractors.
 - The chart shall indicate how the Design-Build Team intends to divide the project into work segments to enable optimum construction performance.
 - Descriptions of those categories of work that the Design-Build Team anticipates will be performed by the Design-Build Team's own direct labor force and those categories that will be performed by subcontractors.
 - The Design-Build Team's plans and procedures to insure timely deliveries of materials to achieve the project schedule.

- Describe the overall strengths of the construction team and their ability to fulfill the construction and construction management requirements of this project.
- Describe the Design-Build Team's approach to site access and material staging.

2. Responsiveness to RFP – 20 points

Natural Environmental Responsibility

- Describe the Design-Build Team's approach to addressing environmental concerns within the project boundaries.
- Identify efforts to minimize impacts on wetlands, streams, riparian buffers, and other environmentally sensitive areas.
- Describe any Notice of Violations (NOV's) or Immediate Corrective Actions (ICA's) the Design-Build Team members have received and the disposition of any NOV's or ICA's.
- Describe the Design-Build Teams approach to Sedimentation and Erosion Control for the project.
- Describe efforts to minimize or avoid any contaminated sites.

Design Features

- Show plan view of design concepts with key elements noted.
- Identify preliminary horizontal and vertical alignments of all roadway elements.
- Show typical sections for the mainline of the project.
- Identify drainage modifications and designs to be implemented.
- Identify the appropriate design criteria for each feature if not provided.
- Identify all bridge types to be constructed, including any special design features or construction techniques needed.
- Identify any deviations, including proposed design exceptions, from the established design criteria that will be utilized. Explain why the deviation is necessary.
- Describe any geotechnical investigations to be performed by the Design-Build Team.
- Identify any special aesthetics considerations that will be part of the design.
- Describe how any utility conflicts will be addressed and any special utility design considerations. Describe how the Design-Build Team's design and construction methods minimize the Department's utility relocation costs.
- Describe if the design will require any additional right-of-way or easements beyond that already acquired by the Department, and if so, to what extent.
- Identify types of any retaining walls and / or sound barrier walls if applicable.
- Identify the pavement base option chosen, ABC or asphalt, for all -Y- Lines.

3. Long Term Maintenance – 5 points

- Describe any special materials, not referenced elsewhere in the contract, incorporated into the project that would result in long term reduction in maintenance.

- Describe any special designs or construction methods that would reduce future maintenance costs to the Department.
- Estimate a minimum ten-year cost saving resulting from incorporation of these special materials, design, or construction methods into the project.

4. Schedule and Milestones – 30 points

- Provide a detailed schedule for the project including both design and construction activities. The schedule shall show the sequence and continuity of operations, as well as the month of delivery of usable segments of the project.
- The schedule shall also include the Design-Build Team's final completion date and, if proposed, their substantial completion date. **These dates shall be clearly indicated on the Project Schedule and labeled "Final Completion Date" and "Substantial Completion Date"**.

5. Innovation – 4 points

- Identify any aspects of the design or construction elements that the Design-Build Team considers innovative. Include a description of alternatives that were considered whether implemented or not.

6. Maintenance of Traffic and Safety Plan – 25 points

Maintenance of Traffic

- Describe any traffic control requirements that will be used for each construction phase.
- Describe how the planned staging of the work and the traffic control requirements will accommodate the anticipated schedule for the I-2304AC project to the south. Describe how flexible the traffic control plan is in regards to this coordination.
- Describe how traffic will be maintained as appropriate and describe the Design-Build Team's understanding of any time restrictions noted in the RFP.
- Specifically describe how business, school, and residential access will be maintained, if applicable.
- Address how hauling will be conducted.
- If a temporary portable barrier system will be utilized, provide the type and why it is needed.
- If temporary shoring will be required, provide the type and why it is required.
- Include all proposed offsite detours; reason for need and duration.
- Indicate the intent to shift the I-85 Business southbound on-ramp lane drop northward outside the limits of ramp reconstruction, providing specific design details and duration.
- Address where and how law enforcement officers will be used.

Safety Plan

- Describe the safety considerations specific to the project.
- Discuss the Design-Build Team's overall approach to safety.
- Describe any proposed improvements that will be made prior to or during construction that will enhance the safety of the work force and/or travelling public both during and after the construction of the project.

7. Oral Interview – 3 points

- The Design-Build Team's Project Management Team shall present a brief introduction of the project team and design / construction approach.
- Introductory comments shall be held to no more than 25 minutes.
- The Department will use this interview to ask specific questions about the Team's Technical Proposal, background, philosophies, and approach to the project.
- Presentation, questions, and answers shall not exceed 75 minutes. No more than 10 people from the Design-Build Team may attend.

The Department will use the information presented in the oral interview to assist in the evaluation of the Technical Proposal.

Additional Warranty and / or Guarantee

- **The Extra Credit for this project shall be a Maximum of 5 Points.**

A twelve-month guarantee as outlined in the *Twelve-Month Guarantee* Project Special Provision is required for this project. However, the Design-Build Team may provide additional warranties and / or guarantees at their discretion. The Design-Build Team may be awarded additional points as "extra credit" to be added to the Technical Score.

The Design-Build Team may provide warranties and / or guarantees for major components of the project. Examples of major components are pavements, bridge components, and sign structures. If additional warranties and / or guarantees are offered, the Design-Build Team shall indicate in the Technical Proposal the general terms of the warranties and / or guarantees, a list of the items covered, performance parameters, notification and response parameters for corrective action, and evaluation periods. The Department will be responsible for annual inspections of the components covered by all warranties and / or guarantees offered by the Design-Build Team that extend beyond the required Twelve-Month Guarantee. The warranties and / or guarantees shall also define how disputes will be handled. Prior to the first partial payment, the Design-Build Team shall submit a document that provides additional warranty / guarantee specifics in sufficient detail that allows the document to be made a part of the contract through supplemental agreement.

No direct payment will be made for warranties and / or guarantees. Payment will be considered incidental to the lump sum price for the contract.

SELECTION PROCEDURE

There will be a Technical Review Committee (TRC) composed of five or more senior personnel from involved engineering groups that will evaluate the Technical Proposal on the basis of the criteria provided in the Request for Proposals.

The selection of a Design-Build Team will involve both technical quality and price. The Technical Proposals will be presented to the TRC for evaluation. The TRC shall first determine whether the proposals are responsive to the requirements of the Request for Proposals. The Department reserves the right to ask for clarification on any item in the Technical Proposal. A written response to this request for clarification shall be provided to the Department prior to the opening of the Price Proposals. The contents of the written response may affect the Technical Review Committee's determination of the Technical Proposal's responsiveness and/or the overall evaluation of the Technical Proposal. If any commitments or clarifications provided in the written response conflict with the contents of the Technical Proposal, the contents of the written response will govern and be incorporated into the contract.

Each responsive Technical Proposal shall be evaluated based on the rating criteria provided in the Request for Proposals. The TRC will submit an overall consensus Technical Proposal score for each Design-Build Team to the State Contract Officer.

Quality Credit Evaluation Factors for Technical Proposals

Management	13
Responsiveness to Request for Proposal	20
Long Term Maintenance	5
Schedule and Milestones	30
Innovation	4
Maintenance of Traffic and Safety Plan	25
Oral Interview	3
Maximum Score	100

The State Contract Officer will use a table based on the maximum quality credit percentage to assign a Quality Credit Percentage to each proposal based on the proposal's overall Technical Score. The maximum quality credit percentage for this project will be **15%**.

Quality Credit Percentage for Technical Proposals

Technical Score	Quality Credit (%)	Technical Score	Quality Credit (%)
100	15.00	84	7.00
99	14.50	83	6.50
98	14.00	82	6.00
97	13.50	81	5.50
96	13.00	80	5.00
95	12.50	79	4.50
94	12.00	78	4.00
93	11.50	77	3.50
92	11.00	76	3.00
91	10.50	75	2.50
90	10.00	74	2.00
89	9.50	73	1.50
88	9.00	72	1.00
87	8.50	71	0.50
86	8.00	70	0.00
85	7.50		

The maximum Technical Score, including any extra credit given for warranties or guarantees, shall not exceed 100 points in determining the Quality Credit percentage.

If any of the Technical Proposals are considered non-responsive, the State Contract Officer will notify those Design-Build Teams of that fact. The State Contract Officer shall publicly open the sealed Price Proposals and multiply each Design-Build Team's Price Proposal by the Quality Credit Percentage earned by the Design-Build Team's Technical Proposal to obtain the Quality Value of each Design-Build Team's Technical Proposal. The Quality Value will then be subtracted from each Design-Build Team's Price Proposal to obtain an Adjusted Price based upon Price and Quality combined. Unless all Proposals are rejected or the Department elects to proceed with the Best and Final Offer process, the Department will recommend to the State Transportation Board that the Design-Build Team having the lowest adjusted price be awarded the contract. The cost of the Design-Build contract will be the amount received as the Price Proposal.

The following table shows an example of the calculations involved in this process.

An Example of Calculating Quality Adjusted Price Ranking

Proposal	Technical Score	Quality Credit (%)	Price Proposal (\$)	Quality Value (\$)	Adjusted Price (\$)
A	95	12.50	3,000,000	375,000	2,625,000
B	90	10.00	2,900,000	290,000	2,610,000
C *	90	10.00	2,800,000	280,000	2,520,000
D	80	5.00	2,700,000	135,000	2,565,000
E	70	0.00	2,600,000	0	2,600,000
* Successful Design-Build Team – Contract Cost \$2,800,000					

Opening of Price Proposals

Prior to opening the Price Proposals, the State Contract Officer will provide to each Design-Build Team their Technical Score in a sealed envelope. The sealed envelope will contain that Team's score only.

At the time and date specified, the State Contract Officer will open the Price Proposals and calculate the percentage difference between the Price Proposals submitted and the Engineer's Estimate.

Should all of the Price Proposals be within an acceptable range or below the Engineer's Estimate the State Contract Officer will proceed to calculate the quality credit and publicly read the Price Proposal, Technical Score, and Adjusted Price as outlined in the selection procedure above.

Should any one or more of the Price Proposals be within an acceptable range or below the Engineer's Estimate and the remaining Price Proposals exceed an acceptable range of the Engineer's Estimate the State Contract Officer will go to a separate location to calculate the quality credit and determine if the Design-Build Team with the lowest Adjusted Price is within an acceptable range of the Engineer's Estimate. Should the Price Proposal of the Design-Build Team with the lowest Adjusted Price be within an acceptable range of the Engineer's Estimate or below the Engineer's Estimate the State Contract Officer will proceed to publicly read the Price Proposals, Technical Scores, and Adjusted Prices. Should the Price Proposal of the Design-Build Team with the lowest Adjusted Price exceed an acceptable range of the Engineer's Estimate the State Contract Officer will publicly read the Price Proposals only and the Department will then determine whether to proceed to request a Best and Final Offer (BAFO) as outlined below.

Should all Price Proposals submitted exceed an acceptable range of the Engineer's Estimate the State Contract Officer will publicly read the Price Proposals only. The Department will then determine whether to proceed to request a Best and Final Offer (BAFO) as outlined below.

In the event that the Department elects to not proceed with a Best and Final Offer (BAFO), then the State Contract Officer will schedule a date and time to publicly reiterate all Price Proposals, and read all Technical Scores and Adjusted Prices.

Provided the Department elects to proceed to request a Best and Final Offer (BAFO), at the date and time specified, the State Contract Officer will open the Best and Final Offer Price Proposals and proceed to publicly read all Price Proposals, Technical Scores and Adjusted Prices.

Best and Final Offer

In the event initial Price Proposals exceed an acceptable range of the Engineer's Estimate or if the Department feels it is necessary for any reason the Department may choose to make amendments to the details of the RFP and request a Best and Final Offer from all of the previously short-listed teams. Alternately, the Department may choose to redistribute to the short-listed Design-Build Teams another RFP for the project with no amendments to the RFP scope.

After receipt of the redistributed RFP, the Design-Build Team has the option of changing their Technical Proposal details. If the Design-Build Team changes any component of the Technical Proposal, the TRC will review those amended components of the Technical Proposal and reevaluate the scores accordingly. The Design-Build Team shall highlight the changes to bring them to the Department's attention. A revised total score will be calculated, if appropriate, based on these amendments to the Technical Proposal.

Additional oral interviews will not be held. The Design-Build Teams shall submit both a revised Price Proposal and a revised Technical Proposal (if applicable) at the time, place, and date specified in the redistributed RFP. A revised Quality Credit Percentage (if required) and Adjusted Price will be determined. This will constitute the Design-Build Team's Best and Final Offer. Award of the project may be made to the Design-Build Team with the lowest Adjusted Price on this Best and Final Offer for the project.

Stipend

A stipulated fee of **\$75,000** will be awarded to each short-listed Design-Build Team that provides a responsive, but unsuccessful, Design-Build Proposal. If a contract award is not made, all short-listed Design-Build Teams that provide a responsive Design-Build Proposal shall receive the stipulated fee. Once award is made, or a decision is made not to award, unsuccessful Design-Build Teams will be notified of the opportunity to apply for the stipulated fee. If the Design-Build Team accepts the stipulated fee, the Department reserves the right to use any ideas or information contained in the Design-Build Proposals in connection with any contract awarded for the project, or in connection with any subsequent procurement, with no obligation to pay additional compensation to the unsuccessful Design-Build Team. The stipulated fee shall be paid to eligible Design-Build Teams within ninety days after the award of the contract or the decision not to award. Unsuccessful Design-Build Teams may elect to refuse payment of the stipulated fee and retain any rights to its Design-Build Proposal and the ideas and information contained therein.

In the event that the Department suspends or discontinues the procurement process prior to the Design-Build Proposal submittal date current at the time of the suspension, no stipulated fee will be paid.

ROADWAY SCOPE OF WORK (10-12-10)

It should be noted that TIP Project I-2304AD, as referenced herein, represents a project formerly designated as I-2304AB. All references to project I-2304AB in material provided by the Department shall apply to this project.

The plans referred to herein as the I-2304AB Right of Way Plans provided [or developed] by the Department are the hard copy of the Right of Way Plans distributed on October 21, 2010.

Project Details

- The Design-Build Team shall design and construct an eight-lane divided freeway with a minimum 46-foot median from north of NC 150 to south of I-85 Business in Davidson County. Unless noted otherwise elsewhere in this RFP, the Design-Build Team shall design and construct the -L- Line providing the same or better access, widening and improvements included in the I-2304AB Right of Way Plans provided by the Department. The northern limits of -L- Line construction shall be of sufficient length to tie to existing based upon the current NCDOT guidelines and standards. The mainline shall be designed and constructed to meet a 70-mph design speed for a rolling rural freeway designed to Interstate standards. The Design-Build Team shall provide all other design criteria in the Technical Proposal.
- At the project's southern terminus, the reconstructed and new I-85 southbound and northbound lanes shall begin at Station 980+00 -L- and extend to at least Station 1169+68.50 -L- of the I-2304AB Right of Way Plans provided by the Department.
 - From the aforementioned southern terminus northward, the Design-Build Team shall design and construct northbound I-85 such that the ultimate improvements, including but not limited to four through lanes and auxiliary lanes, are provided to at least Station 1161+28.5 -L- of the I-2304AB Right of Way Plans provided by the Department.
 - From the aforementioned southern terminus northward, the Design-Build Team shall design and construct southbound I-85 such that the ultimate improvements, including but not limited to four through lanes and auxiliary lanes, are provided to the I-85 Business southbound on-ramp. From the I-85 Business southbound on-ramp northward, the Design-Build Team shall design and reconstruct three I-85 southbound through lanes to at least the northern terminus noted above.
- The Design-Build Team shall coordinate with Project I-2304AC design and construction to ensure accurate hydrology, capacity, and horizontal and vertical ties that adhere to the design criteria. The Design-Build Team shall not make any design or construction changes that affect the design or construction of Project I-2304AC without prior written approval from the Transportation Program Management Director. (Reference the Cooperation Between Contractors Project Special Provision found elsewhere in this RFP)

- Along the -L- Line, the Design-Build Team shall provide minimum 14-foot outside and median shoulders, 12-foot of which shall be full depth concrete paved shoulders. The median shoulders shall be designed and constructed to accommodate a future travel lane with appropriate cross slope.
- Along the I-85 travel lanes, the Design-Build Team shall provide milled rumble strips along the outside paved shoulders, including acceleration, deceleration, and auxiliary lanes / ramps to the back of the gore (12-foot width). Along the -L- Line, the Design-Build Team shall provide thermoplastic rumble strips along the median paved shoulders in accordance with the detail provided by the Department.
- The Design-Build Team shall design and construct one-lane ramps that provide a minimum 16-foot lane width. The Design-Build Team shall design and construct two lane ramps that provide minimum 12-foot lanes. The Design-Build Team shall provide the following ramp shoulders:
 - Belmont Road - All ramps shall have 12-foot inside shoulders, four-foot of which shall be full depth paved shoulders. All ramps shall have 14-foot outside shoulders, four-foot of which shall be full depth paved shoulders and eight-foot of which shall be partial depth paved shoulders.
 - I-85 Business - All ramps shall have 14-foot inside and outside shoulders, 12-foot of which shall be full depth paved shoulders.
- The Design-Build Team shall design and construct one-lane loops that adhere to Exhibit 3-51, *Design Widths of Pavements for Turning Roadways*, shown in AASHTO's *A Policy on Geometric Design of Highways and Streets* (2004) - Case II / Condition C. All loops shall have a 12-foot outside shoulders, four-foot of which shall be full depth paved shoulders and 2'-6" curb and gutter along the inside edge of pavement, with a 14-foot berm. The minimum loop design speed shall be 30-mph with a minimum 260-foot radius.
- The Design-Build Team shall design and construct the Hargrave Road southbound on-ramp in accordance with the 2004 AASHTO *A Policy on Geometric Design of Highways and Streets* and the NCDOT Standard Roadway Drawings, including but not limited to providing required acceleration length and shoulder width.
- At Old Salisbury Road (Old US 29 – US 70), the east leg of Belmont Road and the west leg of Belmont Road (extending into a new subdivision) shall not be offset.
- Continuously between the Belmont Road Loops -B- and -C-, the Design-Build Team shall design and construct a five-lane section. The Belmont Road structure width over I-85 shall be in accordance with the Revised Structure Recommendations approved on July 13, 2004. Within these limits, the outside lanes shall serve as right turn lanes for Loop -C- and Service Road –SRA-.

- In accordance with Congestion Management’s guidelines, the Design-Build Team shall be responsible for capacity analysis for turn lanes lengths and lane configurations at intersections and ramp / loop terminals using 2035 traffic volumes provided by the Department. All intersection turn lane lengths shall meet the current NCDOT standards where vehicle storage does not govern or the aforementioned capacity analysis, whichever is greater. This determination shall be made by calculating the recommended treatment for turn lanes, incorporating the minimum deceleration lengths as defined in the NCDOT Roadway Design Manual (Reference Section 9-1, Figure F-4A), and comparing the calculated values with the NCDOT minimum turn lane lengths.
- Roundabouts will not be allowed. At all ramp and loop intersections with -Y- Lines, the design vehicle for all turning movements shall be a WB-65. Unless noted otherwise elsewhere in this RFP, the design vehicle for all other turning movements shall be a WB-50.
- The Design-Build Team shall provide turn arounds on all roads that are dead-ended. Along Wayne Gobble Road (SR 1288), the Design-Build Team shall provide a T-type turnaround north of the most northern property line of Parcel No. 40. From this turnaround southward, the Design-Build Team shall provide a minimum ten-foot paved facility that ties to the existing ten-foot gravel facility located at approximately Station 1125+00 -L-, LT.
- With the exception of the I-85 northbound lane drop required to tie to existing, the Design-Build Team shall design and construct all lane drops from the outside roadway.
- Unless noted otherwise elsewhere in this scope of work, the Design-Build Team shall design and construct -Y- Lines, ramps and service roads providing the same or better access, widening and improvements included in the I-2304AB Right of Way Plans provided by the Department. The limits of -Y- Line and service road construction shall be of sufficient length to tie to existing based upon the current NCDOT guidelines and standards.
- Functional classifications that have a defined usable shoulder width shall have the appropriately wider overall shoulder width.
- I-85 is a full control of access facility. The Department has acquired all right of way, easements, and control of access required for the Department’s preliminary design. The Design-Build Team shall bring to the Transportation Program Management Director’s attention any deviations from the proposed control of access shown on the I-2304AB Right of Way Plans. The Design-Build Team shall provide all services and costs required for acquiring all additional right of way, easements, and / or control of access, including but not limited to direct payments to property owners for negotiated settlements, recording fees, relocation benefits, and deposits and fees involved with filing of condemnation, resulting from design revisions and / or construction methods. If required, parcel names and deed research descriptions shall be the responsibility of the

Design-Build Team to acquire and process. Prior to negotiating additional right of way, easements, and / or control of access with property owners, the Design-Build Team shall delineate the additional takes on the Right of Way Plans developed by the Design-Build Team for the Department's review and acceptance. The Design-Build Team shall be responsible for coordinating with, and obtaining approval from, the NCDOT for the woven wire fence placement. Throughout the project limits, the Design-Build Team shall be responsible for installation of the woven wire fence along the Control of Access, including the replacement of all existing woven wire fence.

- The Design-Build Team shall be responsible for the location and installation of all right of way concrete monuments, including but not limited to right of way already secured by the Department. As shown on the Right of Way Plans developed by the Department, the NCDOT has staked the proposed right of way and easements with wooden stakes. The Design-Build Team shall be responsible for confirming the accuracy of the wooden stake locations. The Design-Build Team shall re-place all existing right of way monuments damaged and / or relocated during construction.
- Unless noted otherwise elsewhere in this RFP, all guardrail placement shall be in accordance with the July 2006 NCDOT *Standard Drawings* and / or approved details in lieu of standards. Along the I-85 median, double faced steel beam guardrail shall be used. Along all 3:1 fill slopes, constructed at fill heights that are greater than 12 feet, the Design-Build Team shall install guardrail. Along all fill slopes steeper than 3:1, constructed at fill heights that are equal to or greater and six feet, the Design-Build Team shall install guardrail. The guardrail design shall be submitted for review with the Preliminary Plans submittal.
- The Design-Build Team shall design and construct bridge rail offsets as indicated in the NCDOT *Roadway Design Manual* or that are equal to the approach roadway paved shoulders, whichever is greater
- The Design-Build Team shall not further impact any cultural, historical, or otherwise protected landmark or topographic feature beyond that shown on the I-2304AB Right of Way Plans developed by the Department. The Design-Build Team shall not utilize the Yadkin River Crossings Historic District as a waste site, borrow pit, staging area or any other activity.
- Excluding haul roads, the Design-Build Team shall design and construct resurfacing grades for all roadways impacted by construction. All resurfacing grades shall adhere to the design criteria and standards, provide all required pavement wedging (Reference the Pavement Management Scope of Work found elsewhere in this RFP) and adhere to the minimum requirements noted below:
 - The Design-Build Team shall resurface all lanes and shoulders of an undivided facility throughout the limits of proposed widening and construction.

- The Design-Build Team shall resurface each one-way roadway of a divided facility throughout the limits of the one-way roadway widening and construction, allowing varying resurfacing limits for the opposing directions of travel.
- For both divided and undivided facilities, the Design-Build Team shall resurface all lanes and shoulders within the outermost construction limits of all proposed widening and construction, including any gaps along the facility where construction activities are not required.
- The Design-Build Team shall resurface all existing facilities to the limits of pavement marking obliterations / revisions.
- Unless noted otherwise elsewhere in this RFP, the maximum allowable cut and fill slope shall be 2:1(Reference the Geotechnical Engineering Scope of Work found elsewhere in this RFP). The slopes in the interchange areas shall follow the requirements set forth in the *Roadway Design Guidelines for Design-Build Projects* located on the Design-Build web site. Inside the interchange quadrants the maximum slope allowed shall be 4:1.
- The Design-Build Team shall inform the Transportation Program Management Director, in writing, of any proposed changes to the NCDOT preliminary design, previously reviewed submittals or the Design-Build Team's Technical Proposal and obtain approval prior to incorporation. The Design-Build Team shall note in the Technical Proposal any proposed deviations to the preliminary design shown on the I-2304AB Right of Way Plans provided by the Department. The Design-Build Team shall be responsible for any activities, as deemed necessary by the Department or the FHWA, resulting from changes to the NCDOT preliminary design, including but not limited to, public involvement and NEPA re-evaluation. The Department shall not honor any requests for additional contract time or compensation for completion of the required activities resulting from changes to the NCDOT preliminary design.
- Design exceptions shall not be allowed for the proposed mainline, including all ramps and loops. NCDOT prefers not to have design exceptions for the -Y- Lines and service roads. If the Design-Build Team anticipates any design exceptions, they shall be clearly noted in the Technical Proposal. Prior to requesting / incorporating a design exception into the Final Plans, the Design-Build Team shall obtain prior conceptual approval from the Transportation Program Management Director and the FHWA. If approval is obtained, the Design-Build Team shall be responsible for the development and approval of all design exceptions.
- The Design-Build Team shall submit Structure Recommendations and Design Criteria for NCDOT and FHWA review and acceptance prior to submittal of the Preliminary Plans. The Design-Build Team shall develop Structure Recommendations that adhere to the format noted in the March 25, 2003 and September 1, 2004 memos from Mr. Jay Bennett, PE, State Roadway Design Engineer. The design speed for all roadways shall be the greater of the minimum design speed for the facility type or the anticipated / actual posted speed plus five-mph.

- As currently designed, there are no sound barrier walls required on this project. If the Design-Build Team revises the horizontal and / or vertical alignments such that greater noise impacts are possible on surrounding receptors, the Design-Build Team shall re-analyze and complete a revised noise report, if necessary, for NCDOT and FHWA review and acceptance. The original Final Design Noise Report will be provided to the Design-Build Team to assist in their determination of anticipated additional noise impact on current receptors due to a design change. If sound barrier walls are required as a result of design deviations, the Design-Build Team shall be responsible for all costs associated with the walls, including but not limited to public involvement, wall envelope details, geotechnical investigation, shaft and wall designs, and construction.
- The Design-Build Team shall be responsible for the evaluation of the algebraic difference in rates of cross slope (roll-over) between existing shoulders and roadways and the associated suitability for carrying traffic during construction, if necessary. In the event that the roll-over is found to be unacceptable for the proposed temporary traffic patterns, the Design-Build Team shall be responsible for providing cross slopes that meet design standards and eliminate roll-over concerns.
- Within the vehicle recovery area, the Design-Build Team shall design and construct single face concrete barrier in front of all sound barrier walls located on the outside shoulder in fill sections, retaining walls and all elements acting as a retaining wall.

General

- The design shall be in accordance with the 2004 AASHTO *A Policy on Geometric Design of Highways and Streets*, 2002 NCDOT *Roadway Design Manual*, July 2006 NCDOT *Roadway Standard Drawings* (or as superseded by detail sheets at http://www.ncdot.gov/doh/preconstruct/std_draw/06details/default.html), *Roadway Design Policy and Procedure Manual*, *Roadway Design Guidelines for Design-Build Projects*, 2006 *North Carolina Standard Specifications for Roads and Structures* and the 2002 AASHTO *Roadside Design Guide*, 3rd Edition and 2006 *Chapter 6 Update*.
- If the NCDOT *Roadway Design Manual*, the 2004 AASHTO *A Policy on Geometric Design of Highways and Streets*, the 2006 *Roadway Standard Drawings* and / or any other guidelines, standards or policies have desirable and / or minimum values, the Design-Build Team shall use the desirable values unless otherwise noted elsewhere in this RFP. Similarly, in case of conflicting design parameters, and / or ranges, in the various resources, the proposed design shall adhere to the most conservative values, unless noted otherwise elsewhere in this RFP.
- A sag vertical curve low point shall not be located on any bridge or approach slab.
- The Design-Build Team shall contact Mr. Gary W. Thompson, North Carolina Geodetic Survey Director, prior to disturbing any geodetic monuments.

- The project shall follow the NCDOT-FHWA Stewardship and Oversight Agreement. This agreement shall be provided. Any changes that affect previous approvals shall be re-submitted by the Design-Build Team for FHWA acceptance.
- The Design-Build Team shall identify the need for any special roadway design details (i.e. any special drainage structures, rock embankment, rock plating, special guardrail, retaining walls, concrete barrier designs, etc.) and shall provide special design drawings. The Contracts Standards and Development Unit may have special details available that can be provided to the Design-Build Team upon request.

NCDOT Information Supplied

- The NCDOT will provide copies of the Environmental Assessment (EA), Finding of No Significant Impact (FONSI), Consultation and the latest list of environmental commitments, municipal agreements and all pertinent approvals and correspondence. Unless noted otherwise elsewhere in this RFP, the Design-Build Team shall adhere to all commitments stated in the environmental documents.
- NCDOT will provide electronic surveys for I-2304AD. Any supplemental surveys, including but not limited to additional topography, existing and proposed roadway, structure sites, underground and overhead utilities, existing and proposed drainage, wetland delineation, right of way, parcel names, and deed research and descriptions shall be the responsibility of the Design-Build Team to acquire and process. Known existing utilities have been located and will be included with the survey data. The Design-Build Team shall be responsible for confirming the location of the utilities and the type / size of facilities. All supplemental SUE work shall be the responsibility of the Design-Build Team.
- The NCDOT will provide the I-2304AB Right of Way Plans developed by the Department. The Design-Build Team is cautioned that the preliminary design shown on these plans is provided solely to assist the Design-Build Team in the development of the project design. The Design-Build Team shall be fully and totally responsible for the accuracy and completeness of the project design, including, but not limited to, the use of the NCDOT's design, the use of portions of the NCDOT's design or modifications to the NCDOT's design.
- The NCDOT will provide a Geotechnical Subsurface Investigation for I-2304AD. The Design-Build Team shall be responsible for any additional geotechnical information, all geotechnical recommendations, as well as supplemental structural and roadway investigations (Reference the Geotechnical Engineering Scope of Work).
- The NCDOT will provide final pavement designs. The Design-Build Team shall be responsible for all temporary pavement designs (Reference the Pavement Management Scope of Work).
- The NCDOT will provide I-2304AC Preliminary Plans.

PAVEMENT MANAGEMENT SCOPE OF WORK (10-21-10)

The plans referred to herein as the I-2304AB Right of Way Plans provided [or developed] by the Department are the hard copy of the Right of Way Plans distributed on October 21, 2010.

The pavement design for the mainline and mainline shoulders shall consist of the following:

- 14.0" doweled jointed concrete with 15' uniform joint spacing
- 3.0" B25.0B
- 1.25" SF9.5A
- Subgrade Stabilization

Subgrade stabilization shall be to a minimum depth of 8 inches for lime and 7 inches for cement. The type of subgrade stabilization and amount of stabilizing agent shall be determined in accordance with the Cement and Lime Stabilization of Subgrade Soils Project Special Provision found elsewhere in this RFP.

Other pavement designs for this project are listed in the table below:

LINE	Surface	Intermediate	Base	ABC
-Y3REV-	3.0" S9.5B	3.0" I19.0B	-----	10.0"
-RPB33- and -RPC33- @ -Y3REV-	3.0" S9.5B	3.0" I19.0B	-----	10.0"
-LPB33- and -LPC33- @ -Y3REV-	3.0" S9.5B	4.0" I19.0B	-----	6.0"
-RP85B- and -RP85C-	3.0" S9.5B	3.0" I19.0B	3.5" B25.0B	8.0"
-SRD1-, -SRA-, -SR3- and -SRD-	3.0" S9.5B	2.5" I19.0B	-----	6.0"
-Y7- (SR 1293)	3.0" S9.5B	-----	-----	*10.0"
-DETSRD2- and -SR4-	3.0" S9.5B	-----	-----	*8.0"
-D1-, -D2- and -D3-	1.5" S9.5B	-----	-----	*6.0"

* Prime coat required over ABC

Warm mix asphalt shall not be allowed.

For use as ABC on -Y- Lines and service roads, the Design-Build Team may use crushed concrete aggregate if the required specifications can be met. The crushed material shall meet all source approval requirements such as LA Abrasion and Deleterious Substances with the exception of the Sodium Sulfate test requirement, which is waived. For approval as a source, the Producer must have a stockpile containing at least 300 tons of material meeting a NCDOT standard gradation before samples will be obtained by the Materials Inspector for evaluation. For use as ABC, the material must meet the ABC gradation. The Liquid Limit of the material is raised 5 points to a maximum of 35. Material that is transported to a project from an offsite crushing facility shall be subject to the requirements of the Aggregate Quality Control / Quality Assurance Program.

The minimum depth for overlaying the existing pavement on -Y- Lines shall be the full thickness of surface course as provided in the table above. For the -Y- Lines noted in the table above, the Design-Build Team may substitute an asphalt base course layer for an ABC layer. If such an alternative is proposed, the Design-Build Team shall use an asphalt base course mix specified for the roadway. If an asphalt base course mix is not specified, the Design-Build Team shall use B25.0B base course. The additional thickness of the asphalt base course, used as a substitute for the ABC layer, shall be equal to half of the proposed ABC thickness specified for the roadway. The Design-Build Team shall maintain the same pavement design throughout the -Y- Line construction limits. In the Technical Proposal, the Design-build Team shall specify the base option chosen (ABC or asphalt) for all -Y- Lines. (Reference the Roadway Scope of Work found elsewhere in this RFP)

On all ramps and loops, the adjacent through lane pavement design shall extend to the back of the gore (12-foot width).

The Design-Build Team shall be responsible for the design of all temporary pavements and for the evaluation of existing shoulders and roadways regarding their suitability for carrying traffic during construction, if necessary. In the event that the existing shoulders and roadways are found to be inadequate for the proposed temporary traffic volumes and durations, based on the Department's review of the aforementioned evaluation, the Design-Build Team shall be responsible for upgrading the pavement to an acceptable level. Temporary pavements shall be designed in accordance with the most recent version of the North Carolina DOT *Pavement Design Procedure*. Temporary pavement designs and associated calculations shall be submitted for review and comment using the contract submittal process. The expected duration for traffic on temporary pavement must be included as part of the submittal. (Reference the Roadway Scope of Work)

All driveways, up to the radius point, shall be constructed with the full-depth pavement design of the intersecting roadway. The entire impacted length of all non-concrete driveways with a 10% or steeper grade shall be constructed with 1.5" S9.5B and 8" ABC. Unless otherwise noted above, the Design-Build Team shall adhere to the following for all driveway construction:

For existing gravel and soil driveways, use 8" ABC.

For existing asphalt driveways, use 1.5" S9.5B and 8" ABC.

For existing concrete driveways, use 6" jointed concrete reinforced with woven wire mesh.

In areas where the Design-Build Team's design requires an existing paved facility to accommodate projected traffic volumes other than the Department's projected traffic volumes, the Design-Build Team shall evaluate the existing paved facility regarding its suitability for carrying the Design-Build Team's projected traffic volumes. In the event that the existing paved facility is found to be inadequate, the Design-Build Team shall be responsible for upgrading the existing paved facility to an acceptable level or replacing the existing paved facility. Prior to incorporation, the Design-Build Team shall submit their evaluation and proposed use of the existing paved facility to the Transportation Program Management Director for review and acceptance or rejection.

Excluding the I-85 median guardrail, the Design-Build Team shall pave from the edge of the proposed paved shoulder to the face of all guardrails and to the face of all sound barrier walls located on the outside shoulder in fill sections with 6" of ABC (or 4" B25.0B or B25.0C), a split seal and at least one lift of surface course. If a split seal is not used, the ABC pavement design shall require prime coat at the normal application rate. In these areas, the Design-Build Team's installation of ABC or black base shall be consistent with the pavement type for the specific roadway. As an alternative to the above pavement design for paving shoulders to the face of the guardrail, the Design-Build Team may use the adjacent travel lane pavement design.

The rate of application and the maximum and minimum thickness per application and layer shall be in accordance with the NCDOT Roadway Design Manual.

Shoulder drains are required for this project. The required shoulder drain detail is shown below:

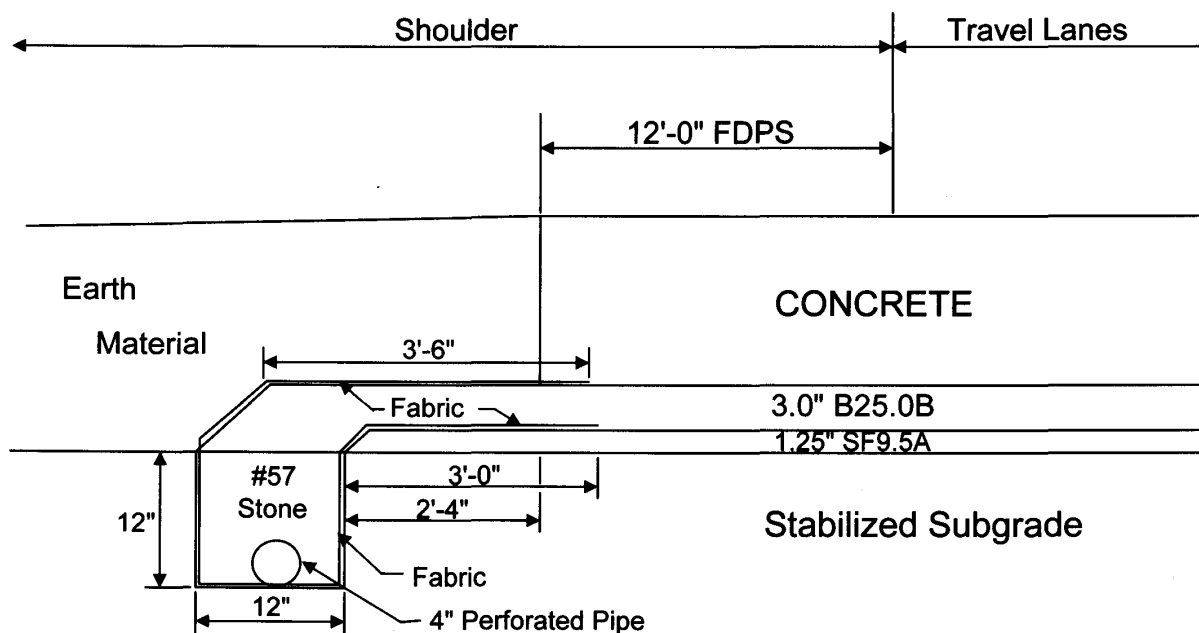

The Design-Build Team shall design and construct shoulder drains and outlets for the mainline. Shoulder drains shall be provided on the low side of cross slopes and / or superelevation throughout all vertical curves, and / or where the grade is less than 1%. Where installed on the median shoulder, outlets shall be provided at every drainage structure. Where installed on the outside shoulder, outlets shall be provided approximately every 300 feet. Shoulder drains shall be placed to drain the entire pavement structure. The preliminary locations of shoulder drain installations for this project, as required by the I-2304AB Right of Way Plans provided by the Department, are listed in the table below. At a minimum, the Design-Build Team shall verify that the shoulder drain locations and outlets below provide adequate drainage; and install those shoulder drains and outlets as required by design.

LINE	SIDE	Begin Station	End Station	OUTLET LOCATIONS
-L-	NBL, Outside	980+00	986+77	980+00, 983+50
-L-	NBL, Outside	986+77	1009+60	991+00(2GI), 993+60(2GI), 996+50, 999+50, 1002+50, 1006+00(2GI), 1007+50(2GI), 1009+60(JB)
-L-	NBL, Outside	1029+00	1041+00	1033+00(2GI), 1035+50(2GI), 1037+65± (2GI), 1039+50(2GI)
-L-	NBL, Outside	1045+50	1051+00	1045+50, 1047+00
-L-	NBL, Outside	1058+50	1063+50	1058+50, 1061+00
-L-	NBL, Outside	1064+50	1107+10	1068+60(2GI), 1070+50, 1073+62 (2GI), 1075+50(2GI), 1077+00(2GI), 1078+71± (2GI), 1079+00(2GI), 1081+50(2GI), 1086+00(2GI), 1087+64(2GI), 1091+00, 1094+00, 1097+00(2GI), 1098+09(2GI), 1099+26(2GI), 1100+41(2GI), 1102+00(2GI), 1104+10(2GI)
-L-	NBL, Outside	1107+10	1110+50	1110+50
-L-	NBL, Outside	1116+00	1131+00	1119+10(2GI), 1122+50(2GI), 1126+50(2GI), 1127+50(2GI), 1131+00
-L-	NBL, Outside	1136+00	1168+00	1138+50, 1141+50, 1144+50, 1147+50, 1149+15± , 1152+00(2GI), 1156+20(JB), 1160+70(JB), 1164+40(JB)
-L-	SBL, Outside	987+00	1015+00	990+50(2GI), 993+50, 997+00, 1000+00, 1003+00, 1006+50, 1010+00, 1015+00(2GI)
-L-	SBL, Outside	1030+00	1040+10	1034+00(3GI), 1037+55± (2GI), 1038+50(2GI)
-L-	SBL, Outside	1044+50	1052+00	1044+50, 1048+50
-L-	SBL, Outside	1058+00	1062+00	1058+00(3GI)
-L-	SBL, Outside	1064+00	1095+35	1067+00(2GI), 1070+00(2GI), 1072+50(2GI), 1075+00(2GI), 1077+00(2GI), 1078+35(2GI), 1078+71± (2GI), 1079+50(2GI), 1081+50(2GI), 1084+00(2GI), 1086+50(2GI), 1089+45(2GI), 1090+00(2GI), 1092+50(2GI)
-L-	SBL, Outside	1104+86	1107+10	1104+86(2GI)

-L-	SBL, Outside	1120+50	1139+00	1124+50(2GI), 1129+00(2GI), 1129+96(2GI), 1131+80(2GI), 1134+72(2GI), 1139+00(2GI)
-L-	SBL, Outside	1157+43	1161+00	1157+43(2GI)
-L-	NBL & SBL, Median	988+00	1009+60	992+00(2GI), 993+60(2GI), 997+30 (2GI), 999+66(2GI), 1003+10(2GI), 1007+50(2GI), 1009+60(2GI)
-L-	NBL, Median	1013+00	1027+65	1016+60(2GI), 1019+25(2GI), 1021+65(2GI), 1027+65(2GI)
-L-	NBL & SBL, Median	1029+00	1050+00	1032+65(2GI), 1036+60(2GI), 1037+65± (3GI), 1039+00(2GI), 1042+65(2GI), 1046+62(2GI)
-L-	NBL & SBL, Median	1070+00	1084+00	1073+62(2GI), 1078+71± (3GI), 1080+65(2GI)
-L-	NBL, Median	1103+92	1107+00	1103+92(2GI)
-L-	NBL, Median	1130+00	1136+35	1133+10(2GI), 1136+35(2GI)
-L-	NBL, Median	1157+03	1161+00	1157+03(2GI)
-L-	SBL, Median	1095+00	1107+00	1095+00 (2GI), 1097+00 (2GI), 1099+00 (2GI), 1101+50 (2GI), 1103+92 (2GI)
-L-	SBL, Median	1130+00	1148+50	1133+10(2GI), 1136+35(2GI), 1137+60(2GI), 1141+85(2GI), 1146+00(2GI), 1148+50(2GI)
-L-	SBL, Median	1149+54	1157+65	1149+54(2GI), 1150+90(2GI), 1153+00(2GI)

Note: **Station±** : indicates vertical sag which has two outlets. (Ex. 953+99±)

STRUCTURES SCOPE OF WORK (10-20-10)**Project Details**

The Design-Build Team shall be responsible for the design and construction of all structures necessary to complete the project.

Anticipated Structures:

- Bridge on -Y3REV- at I-85 (-Y3REV- is labeled as SR 3159 south of I-85 and SR 1133 north of I-85)
- Reinforced Concrete Box Culvert, Station 29+00 -Y3REV-
- Reinforced Concrete Box Culvert, Station 12+50 -SRD-
- Reinforced Concrete Box Culvert Station 1036+25 -L- (I-85)
- Retaining Wall(s), Station 1015+60 to 1016+30 -L- (I-85)

All bridges shall meet approved Roadway typical sections and grades. Bridge geometry (width, length, skew, span arrangement, etc.) shall be in accordance with the approved Structure Recommendation. Box Culverts shall be in accordance with approved Culvert Survey Reports.

A live load rating chart for girders will be required on the bridge plans. The load rating shall be in accordance with the August 21, 2009, LRFR Load Factors memo (Rev. December 2009) and AASHTO's Manual for Bridge Evaluation.

The minimum vertical clearance required for bridges over I-85 is 17'-0".

Cored slab, AASHTO box girders, steel tub girders, deck girders, fracture critical bridges, and cast-in-place deck slab bridges will not be allowed.

The empirical method of deck design will not be allowed.

For the required width of the Belmont Road bridge, reference the Roadway Scope of Work. This bridge shall have standard New Jersey barrier rails.

Shoulder piers for grade separations crossing I-85 are not allowed. MSE walls are allowed in front of end bents for grade separations provided the horizontal clearance allows for the full typical roadway section, shoulder and barrier rail.

Any required bridge attachments (e.g. ITS conduit, water lines) will not be allowed in the overhang of grade separations. Casting of conduit in the bridge deck or railing will not be allowed.

Bridge Removal:

The Design Build Team is responsible for the removal and disposal of the following structures:

- Davidson County Bridge #001 (SR 1133 [Belmont Boulevard] over I-85)
- Davidson County Bridge #111 (SR1295 [Clark Rd] over I-85)

General

The Design-Build Team's primary design firm shall be on the Highway Design Branch list of firms qualified for Structure Design and maintain an office in North Carolina.

Design shall be in accordance with *AASHTO LRFD Bridge Design Specifications, 4th Edition* with 2008 Interim Revisions or more recent edition, NCDOT LRFD Driven Pile Foundation Design Policy, NCDOT Structure Design Manual (including policy memos), and NCDOT Bridge Policy Manual. Culverts and culvert extensions shall be designed in accordance with *AASHTO Standard Specifications for Highway Bridges, 16th Edition* with 1998 Interim revisions, NCDOT Structure Design Manual (including policy memos), and NCDOT Bridge Policy Manual.

Construction and materials shall be in accordance with the 2006 *NCDOT Standard Specifications for Roads and Structures*, NCDOT Structure Design Unit Project Special Provisions, and NCDOT Structure Design Unit Standard Drawings.

Attachment of sign structures to bridges shall not be allowed. Monotube sign supports shall not be allowed. Monotube or cantilever DMS support structures shall not be allowed.

Stay-in-Place Forms for interior and end bent diaphragm construction shall not be allowed.

Alternate designs, details, or construction practices (such as those employed by other states, but not standard practice in NC) are subject to Department review and shall be evaluated on a case by case basis. The Design-Build Team may use non-standard pre-stressed concrete girder shapes provided they have been previously used in North Carolina or other states; and they are detailed with a concrete cover consistent with that used on the North Carolina standard shapes.

GEOTECHNICAL ENGINEERING SCOPE OF WORK (10-20-10)**I. GENERAL:**

Obtain the services of a firm prequalified for geotechnical work by the Highway Design Branch List. The prequalified geotechnical firm shall prepare foundation design recommendation reports for use in designing structure foundations, roadway foundations, retaining walls, overhead sign structure foundations, overhead sign structures, and temporary structures.

The Engineer of Record who prepares the foundation design recommendation reports shall be a Professional Engineer registered in the State of North Carolina who has completed a minimum of three geotechnical design projects of scope and complexity similar to that anticipated for this project using the load and resistance factor design (LRFD) method and in accordance with the latest edition of the AASHTO *LRFD Bridge Design Specification*. If the Engineer of Record cannot demonstrate the aforementioned LRFD experience, then the design must undergo a peer review by an individual with such experience. In such case, the reviewer must be a registered Professional Engineer, but not necessarily in the State of North Carolina. Prior to the first geotechnical design submittal, the Design-Build Team shall provide a letter to the NCDOT Design-Build Office that documents the reviewer's LRFD experience for review and acceptance. Furthermore, with each geotechnical design submittal, the reviewer shall provide a sealed letter stating that he / she has carefully reviewed and approved the specific submittal details.

The prequalified geotechnical firm shall also determine if additional subsurface information, other than that required and noted elsewhere in this RFP, is required based upon the subsurface information provided by the NCDOT and the final roadway and structure designs. If a determination is made that additional subsurface information is required; the Design-Build Team shall use a prequalified geotechnical firm to perform all additional subsurface investigation and laboratory testing in accordance with the current NCDOT Geotechnical Engineering Unit *Guidelines and Procedures Manual for Subsurface Investigations*. Submit additional information collected by the Design-Build Team to the Geotechnical Engineering Unit for review. The Design-Build Team shall provide the final Subsurface Investigation report in electronic and hardcopy format to the NCDOT for its records.

A minimum of 2 standard penetration test (SPT) / rock core borings shall be required per bent for all bridges. All borings shall be located within 100 feet of the centerline of each bent location to be counted for these minimum requirements. Extend all borings to a depth below the foundation element required to show a complete subsurface profile. The Design-Build Team shall be responsible for obtaining the borings noted above for all bents where subsurface information is not sufficient or is warranted by variability in the geology unless the prequalified geotechnical firm submits documented justification that the subsurface investigation provided by the NCDOT is adequate for design purposes and the justification is acceptable to the Department. Any deviations to the requirements

noted above shall require acceptance from the NCDOT Geotechnical Engineering Unit prior to construction.

The maximum spacing between borings for retaining walls shall be 200 feet, with a minimum of two borings; one at each end of the wall. Drill borings for retaining walls a minimum depth below the bottom of the wall equal to twice the maximum height of the wall.

The Design-Build Team is permitted to design bridges on this project using software that accounts for the structural effects of soil / pier interaction.

II. DESCRIPTION OF WORK:

The Design-Build Team shall design foundations (except sign foundations), embankments, slopes, retaining walls, and sound barriers in accordance with the current edition of the AASHTO *LRFD Bridge Design Specifications*, NCDOT *LRFD Driven Pile Foundation Design Policy*, all applicable NCDOT Geotechnical Engineering Unit Standard Provisions, NCDOT *Structure Design Manual*, and NCDOT *Roadway Design Manual*. The NCDOT *LRFD Driven Pile Foundation Design Policy* is located on the NCDOT Geotechnical Engineering Unit's website at:

www.ncdot.org/doh/preconstruct/highway/geotech/LRFD_Driven_Pile_Foundation_Design_Policy.pdf

For *Geotechnical Guidelines for Design-Build Projects*, the Design-Build Team shall adhere to the guidelines located at the following website:

http://www.ncdot.org/doh/preconstruct/altern/design_build/default.html

A. Structure Foundations

End bent fill slopes up to 35 feet in height (defined as the difference between grade point elevation and finished grade at toe of slope) shall be 1.5:1 (H:V) or flatter. End bent fill slopes with heights greater than 35 feet shall be 2:1 or flatter. All end bent cut slopes shall be 2:1 or flatter. For 1.5:1 fill slopes, extend end bent slope protection from the toe of slope to berm and to 1.75:1 (H:V) slope or to the limits of the superstructure. For cut slopes and for 2:1 or flatter end bent fill slopes, extend end bent slope protection from the toe of slope to berm and to the limits of the superstructure.

Analyze drilled pier and pile bent foundations using either L-Pile or FB-Pier. Design drilled piers and vertical piles with a sufficient embedment in soil and/or rock to achieve "fixity".

B. Roadway Foundations

Unless otherwise noted herein, all unreinforced proposed fill slopes for a slope of 2:1 (H:V) or flatter except bridge end bent slopes (see Section A – Structure Foundations). All proposed soil cut slopes shall be 2:1 (H:V) or flatter, unless the slopes are designed with adequate reinforcement to provide the required stability. Submit detailed design calculations and slope stability analysis for any reinforced cut slopes steeper than 2:1 (H:V) and fill slopes steeper than 2:1 (H:V) to the NCDOT Geotechnical Engineering Unit, via the Transportation Program Management Director, for review and acceptance prior to construction.

Design and construct bridge approach embankments such that no more than two inches of settlement shall occur after the waiting periods end. Soil improvement techniques to mitigate long term settlement problems or to transfer the embankment load to a deeper bearing stratum are allowed. Soil improvement techniques shall follow the current industry standard practices and the guidelines of *Ground Improvement Methods FHWA publication NHI-04-001* or *Geosynthetic Design and Construction Guidelines FHWA-HI-95-038*.

Embankment settlement monitoring shall be required when a waiting period of more than one month is recommended in the foundation design recommendation reports. Use an appropriate method to monitor settlement across the length of the embankment (from toe to toe) such as settlement gauges, surveyed stakes on finished subgrade or other methods but submit documentation describing the method and procedures to the NCDOT Geotechnical Engineering Unit, via the Transportation Program Management Director, for review and acceptance prior to construction of the embankment.

Reinforced bridge approach fills in accordance with the NCDOT standard shall be required for end bents on all bridges.

Mitigate all unsuitable soils to the extent that is required to improve the stability of the proposed embankment or subgrade. Use any suitable material to backfill undercut areas except when employing shallow undercut in accordance with the Aggregate Subgrade Special Provision which requires the use of Select Material, Class IV. For undercut backfilling in water, use Select Material, Class III.

C. Permanent Retaining Wall Structures

For design and construction of mechanically stabilized earth (MSE) retaining walls, refer to the NCDOT Policy for Mechanically Stabilized Earth Retaining Walls which can be found at the NCDOT Geotechnical Engineering Unit's website at:

http://www.ncdot.org/doh/preconstruct/highway/geotech/msewalls/07-12-18_MSE_Retaining_Walls_Policy.pdf

Design and construct permanent retaining walls, with the exception of gravity walls, in accordance with the applicable NCDOT Geotechnical Engineering Unit *Project Special Provisions*, which can be provided upon request by the Design-Build Team. Geotechnical Provisions and Notes can be found at the NCDOT Geotechnical Engineering Unit's website at:

<http://www.ncdot.org/doh/preconstruct/highway/geotech/provnote/>

For each retaining wall, with the exception of gravity walls, submit a wall layout and design. The wall layout submittal shall include the following:

- Wall envelope with top of wall, bottom of wall, existing ground and finished grade elevations at incremental stations.
- Wall alignment with stations and offsets.
- Typical sections showing top and bottom of wall, drainage, embedment, slopes, barriers, fences, etc.
- Calculations for bearing capacity, global stability and settlement.
- Details of conflicts with utilities and drainage structures.
- Roadway plan sheets showing the wall (half size).
- Roadway cross sections showing the wall (half size).
- Traffic control plans showing the wall (half size).

Gravity walls shall be designed and constructed in accordance with the NCDOT Structure Standard Drawings and the NCDOT 2006 *Standard Specifications*. Gravity walls shall be identified in the roadway foundation design recommendation report. Cast-in-place cantilever walls shall be designed and constructed in accordance with the NCDOT 2006 Standard Specifications. Conceptual wall layouts and wall designs shall be submitted for NCDOT for review and acceptance.

Locate retaining walls at toe of slopes unless restricted by right of way limits. The Design-Build Team shall submit global stability calculations for slopes at retaining walls and obtain acceptance from the NCDOT prior to construction. Any slopes behind walls shall be 2:1 (H:V) or flatter.

Drainage over the top of retaining walls shall not be allowed. Sags in the top of walls are not permissible. Direct runoff above and below walls away from walls, if possible, or collect runoff at the walls and transmit it away. Curb and gutter or cast-in-place single faced barrier with paving up to the wall shall be required when runoff can not be directed away from the back or front of the wall. A paved concrete ditch with a minimum depth of six inches shall be required at the top of walls when slopes steeper than 6:1 (H:V) intersect the back of walls.

Precast or cast-in-place coping shall be required for walls without a cast-in-place face with the exception of when a barrier is integrated into the top of the wall. Extend coping or cast-in-place face a minimum of six inches above where the finished or existing grade intersects the back of the wall. A fence shall be

required on top of the facing, coping or barrier or immediately behind the wall, if there is no slope behind the wall.

Deep foundations shall be used for end bents when abutment retaining walls are employed. When using abutment retaining walls, design and construct the end bent and the wall independent of each other. When using abutment retaining walls, the end bent foundation shall be designed and constructed with one of the following deep foundations: (1) a single row of plumb piles with brace piles battered toward the wall, (2) a single row of plumb piles with MSE reinforcement connected to the back of the cap, (3) a double row of plumb piles or (4) drilled piers. If fill is required around piles or drilled piers, install foundations before placing any fill. Wing walls independent of abutment retaining walls shall be required unless accepted otherwise by the NCDOT. Do not consider lateral support from any fill placed around drilled piers behind abutment retaining walls when analyzing end bent stability. All pile foundations for end bents with abutment retaining walls shall penetrate minimum 10 feet into natural ground. For bearing piles behind such retaining walls, the penetration can be reduced to 5 feet below the bottom of the wall provided the Design-Build Team analyzes and determines that the vertical piles are “fixed” in natural ground such that the decrease in pile embedment shall not significantly increase the top deflection under lateral loading. The calculations and supporting documentation for this analysis shall be submitted to the NCDOT for review and acceptance prior to construction.

D. Temporary Structures

Design temporary retaining structures, which include earth retaining structures and cofferdams, in accordance with current allowable stress design AASHTO *Guide Design Specifications for Bridge Temporary Works* and the *Temporary Shoring Special Provision*. The only submittal required to use the standard sheeting design is the “Standard Shoring Selection Form”.

Design and construct temporary retaining walls in accordance with the applicable NCDOT *Project Special Provision* available upon request by the Design-Build Team. Traffic Control barrier on top of walls shall be in accordance with the NCDOT Work Zone Traffic Control Unit details available upon request by the Design-Build Team. If anchored barrier is required, then anchor the barrier in accordance with NCDOT *2006 Roadway Standard Drawing* Detail No. 1170.01.

III. CONSTRUCTION REQUIREMENTS:

All construction and materials shall be in accordance with the NCDOT *2006 Standard Specifications* and current NCDOT *Project Special Provisions* unless otherwise stated in this scope of work. The Design-Build Team shall be responsible for investigating, proposing and incorporating remedial measures for any construction problems related to foundations, retaining walls, subgrades, settlement, slopes, and construction vibrations. The NCDOT Geotechnical Engineering Unit shall review and accept these proposals.

The Design-Build Team shall be responsible for any damage or claim caused by construction, including damage caused by vibration (see Article 107-15 NCDOT *2006 Standard Specifications for Roads and Structures*). The Design-Build Team shall be responsible for deciding what, if any, pre and post-construction monitoring and inventories need to be conducted to satisfy their liability concerns. Any monitoring and inventory work shall be performed by a qualified private engineering firm experienced in the effects of construction on existing structures.

The prequalified geotechnical firm that prepared the foundation designs shall review the embankment settlement monitoring data a minimum of once a month and issue a letter prior to releasing the embankment from the waiting period. Waiting periods may not be ended until less than 0.10 inches of settlement is measured over a period of four weeks. Submit the settlement monitoring data to the Transportation Program Management Director prior to issuing the release letter.

The prequalified geotechnical firm that prepared the foundation designs shall review and approve all pile driving hammers and drilled pier construction sequences. After the prequalified geotechnical firm has approved these submittals, the Design-Build Team shall submit to the NCDOT for review prior to beginning construction.

Perform hammer approvals with GRLWEAP Version 2002 or later and in accordance with the NCDOT *LRFD Driven Pile Foundation Design Policy*. Provide pile driving inspection charts or tables for all approved pile hammers.

Limit driving stresses in accordance with the AASHTO LRFD *Bridge Design Specifications*. If a tip elevation is noted on the plans, drive piles to the minimum required driving resistance and tip elevation. Otherwise, drive piles to the minimum required driving resistance and a penetration into natural ground of at least 10 ft. Unless otherwise approved, stop driving piles when refusal is reached. Refusal is defined as 240 blows per foot or any equivalent set.

Perform Pile Driving Analyzer (PDA) testing using a NCDOT prequalified company to develop pile driving inspection charts or tables. For each permanent bridge that includes driven pile bents or driven pile footings, perform a minimum of one (1) PDA test (dual bridges are counted as one structure) for each pile size, pile type (material or shape) and pile driving hammer combination. Additional PDA tests may be required based upon the AASHTO LRFD Bridge Design Specifications. Provide additional PDA testing for any revisions to pile type, size or hammer previously approved. The locations of specific piles to be tested must be accepted by the NCDOT prior to any PDA test. Perform PDA tests in accordance with ASTM D 4945-89, Standard Test Method for High Strain Dynamic Testing of Piles and this scope of work.

Analyze data with the Case Pile Wave Analysis Program (CAPWAP), version 2006 or later. At a minimum, analysis is required for a hammer blow near the end of initial drive and for each restrike and re-drive. Additional CAPWAP analysis may be required as determined by the Engineer.

Meet the guidelines for NCDOT PDA reports from the Geotechnical Engineering Testing Contract for PDA test reports. To obtain a list of pre-approved Geotechnical Engineering Testing Contract companies to perform PDA testing and guidelines for PDA test report, contact the Geotechnical Engineering Unit at 919-250-4088. PDA testing may be performed by a technician, but PDA testing must be overseen and the reports sealed by a Professional Engineer registered in the State of North Carolina. Submit a complete PDA report sealed by the professional engineer who performed the test to the foundation design firm. The foundation design firm shall develop pile driving inspection charts or tables for acceptance by the NCDOT prior to pile installation.

For drilled-in piles, the following additional requirements apply:

1. Prequalification of contractors is not required for pile excavation or drilled-in pile holes that are 30 inches in diameter or less.
2. Use Class A Concrete in accordance with Article 1000-4 of the NCDOT *2006 Standard Specifications for Roads and Structures* except as modified herein. Provide concrete with a slump of 6 to 8 inches. Use an approved high-range water reducer to achieve this slump. Perform pile excavation to specified elevations shown on the plans. Excavate holes with diameters that will result in at least 3 inches of clearance all around piles. Before filling holes, support and center piles in excavations and when noted on the plans, drive piles to the required driving resistance. Remove any fluid from excavations and fill holes with concrete.
3. Blasting for core removal is only permitted when approved by the Engineer. Dispose of drilling spoils in accordance with Section 802 of the NCDOT *2006 Standard Specifications for Roads and Structures* and as directed by the Engineer. Drilling spoils consist of all excavated materials including fluids removed from excavations by pumps or drilling tools. If unstable, caving or sloughing soils are anticipated or encountered, stabilize excavations with either slurry or steel casing. When using slurry, submit slurry details including product information, manufacturer's recommendations for use, slurry equipment details and written approval from the slurry supplier that the mixing water is acceptable before beginning drilling. When using steel casing, use either the sectional type or one continuous corrugated or non-corrugated piece. Steel casings should consist of clean watertight steel of ample strength to withstand handling and driving stresses and the pressures imposed by concrete, earth and backfill. Use steel casings with an outside diameter equal to the hole size and a minimum wall thickness of ¼ inch.
4. Check the water inflow rate at the bottom of holes after all pumps have been removed. If the inflow rate is less than 6 inches per half hour, remove any fluid and free fall concrete into excavations. Ensure that concrete flows completely around piles. If the water inflow rate is greater than 6 inches per half hour, propose and obtain acceptance of a procedure for placing concrete before filling holes. Place concrete in a continuous manner and remove all casings.

Use current NCDOT inspection forms for drilled piers available on the NCDOT Geotechnical Engineering Unit's webpage. Construct and inspect drilled piers in accordance with the NCDOT *Drilled Piers Special Provision*. The Design-Build Team shall inspect drilled piers using their Shaft Inspection Device (SID) for any pours using the wet method of concrete placement and for any drilled pier excavations that have remained open greater than 24 hours. Install Crosshole Sonic Logging (CSL) tubes in all drilled piers. CSL test a minimum of 25% of drilled piers at each bridge. If a CSL test identifies any defect in the drilled pier, the Department has the right to request additional CSL testing as needed. The Department will determine which piers will be CSL tested. Submit CSL test information and results to the Geotechnical Engineering Unit, via the Transportation Program Management Director, for review and acceptance.

The prequalified geotechnical firm that prepared the original design shall perform any changes to the foundation designs. All changes shall be based upon additional information, subsurface investigation and / or testing. Drilled pier tip elevations shall not be changed during construction unless the prequalified geotechnical firm that prepared the bridge foundation design redesigns the drilled pier from either an SPT / rock core boring, performed in accordance with ASTM standards at the subject pier location, or observations of the drilled pier excavation. If a drilled pier is designed based on a boring, do not drill a boring inside an open drilled pier excavation. Locate the boring within three pier diameters of the center of the subject pier and drill to a depth of two pier diameters below the revised tip elevation. If a drilled pier is redesigned based upon observations of the drilled pier excavation, the geotechnical engineer of record shall be present during the excavation to determine the actual subsurface conditions. Send copies of revised designs including additional subsurface information, calculations and any other supporting documentation sealed by a professional engineer registered in the State of North Carolina to the NCDOT for review.

Conduct proofrolling in accordance with Section 260 of the 2006 *Standard Specifications for Roads and Structures*.

Send copies of any inspection forms related to foundations, settlement or retaining walls to the NCDOT for review.

HYDRAULICS DESIGN SCOPE OF WORK (10-20-10)

The Design-Build Team shall be required to do the following:

- Employ a private engineering firm to perform hydraulic design for all work required under this contract. The private engineering firm shall be prequalified for Hydraulic Design work under the Department's normal prequalification procedures prior to bid submission.
- Hold a pre-design meeting with the Transportation Program Management Director and Hydraulic Review Engineer upon acceptance of the Preliminary Roadway Plans.
- Design the Storm Drainage using Geopak Drainage.
- Provide new Culvert Survey Reports as required by Hydraulic Guidelines stated below. Adjust fill slopes to retain existing culvert at North Potts Creek.
- Replace, in its entirety, the existing RCBC at South Potts Creek with a RCBC that has adequate hydraulic conveyance without the need for supplemental pipes. The culvert invert elevation may be adjusted as needed.
- Develop a Stormwater Management Plan using Best Management Practices as required in the most current NCDOT BMP Toolbox.
- Provide revised permit impact sheets, forms and all other documents necessary for any modifications to the USACE 404 and 401 permits.
- The Design-Build Team shall design the structures on this project to meet the requirements of the new Culvert Survey reports developed by the Design-Build Team and the Memorandum of Agreement (MOA) between NCDOT and NC Floodplain Mapping Program (NCFMP) approved March 2009 for the Department's submittal to FEMA. The Department shall review with NCFMP the eligibility for the MOA. No construction activity shall occur in FEMA regulated floodplains until the MOA package has been reviewed. If the Design-Build Team's design can not meet the requirements of the MOA package, then the Design-Build Team shall prepare a CLOMR package. No construction activity shall occur in FEMA regulated floodplain(s) prior to obtaining an approved CLOMR. The Department will be responsible for all associated fees.
- Construct all culverts to ensure that the as-built plans for the culverts in FEMA regulated floodplains adhere to the approved FEMA submittal. The Department will be responsible submitting a LOMR package if necessary and for all associated fees.
- Prepare Pre and Post Analyses for increases in discharge and take appropriate action in accordance with the guidelines stated below to make sure that additional drainage is adequately handled.
- Use a minimum ditch grade of 0.3% and avoid using ditches in wetlands.

General

- Design in accordance with criteria provided in the North Carolina Division of Highways *Guidelines for Drainage Studies and Hydraulics Design-1999* and the addendum *Handbook of Design for Highway Drainage Studies-1973*, North Carolina Department of Transportation “Stormwater Best Management Practices Toolbox – 2008” and the North Carolina Division of Highways Hydraulics Unit website:

<http://www.ncdot.org/doh/preconstruct/highway/hydro/>

Information supplied

- Original Culvert Survey Reports
- Hydraulic Design Calculations
- Draft 4B Meeting minutes

TRAFFIC MANAGEMENT SCOPE OF WORK (10/20/10)**I. Traffic Management Plans****A. Design Parameters**

The Design-Build Team shall prepare the Traffic Management Plans which includes the Temporary Traffic Control Plan, the Traffic Operations Plan, the Public Information Plan as it relates to the Traffic Control Devices and temporary pavement markings for this project following the parameters listed below:

1. For additional information regarding the components of the Traffic Management Plan, review the Work Zone Safety and Mobility Policy found on the Work Zone Traffic Control Website at:

<http://www.ncdot.gov/doh/preconstruct/wztc/>

2. Except as permitted outside time restrictions noted elsewhere in this RFP the Design-Build Team shall adhere to the following requirements:
 - From the Belmont Road northbound on-loop to the I-85 Business northbound off-ramp, maintain a minimum of three northbound lanes and two southbound lanes on I-85.
 - Except at the location noted above, maintain a minimum of two lanes in each direction of I-85.

Maintain a minimum 11-foot width for all I-85 lanes.

Maintain a minimum of 4' wide paved inside and outside shoulders on I-85 and I-85 Business unless temporary barrier is placed on the paved shoulder.

Maintain existing lane and shoulder widths on all other roadways.

The Design-Build Team may shift the I-85 Business southbound on-ramp lane drop northward outside the limits of ramp reconstruction. Prior to incorporation of this shift, the Design-Build Team shall submit the design to the Department for review and acceptance. The Design-Build Team shall indicate their intent to shift the I-85 Business southbound on-ramp lane drop in their Technical Proposal, providing specific design details and duration.

3. All traffic control devices shall be placed / located a minimum 2-foot offset (shy distance) from the edge of travel lane.
4. Show temporary barrier system on the Traffic Management Staging Concept. Temporary barrier systems shall be designed in accordance with the following requirements:

- Perform an Engineering Study to determine the need for temporary barrier that considers clear zone distances, roadway geometry, anticipated construction year traffic volumes, traffic speeds, roadside geometry, workers safety, pedestrian safety, etc. in accordance with FHWA Final Rule on Temporary Traffic Control Devices (23 CFR 630 Subpart K).
- Reference the NCDOT Work Zone Traffic Control website noted below for examples and Guidelines on the Use of Positive Protection in Work Zones.

<http://ncdot.org/doh/preconstruct/wztc/DesRes/English/DesResEng.html>

- Provide a motorist breakdown area on the right side of the travel way along -L- (I-85) when temporary barrier is used on both sides of a direction of travel for a distance longer than 2000 feet unless the outside useable shoulder width is eight feet or greater. Additional breakdown areas shall be provided every one (1) mile thereafter. All breakdown areas shall be a minimum of 1000-foot long, 14-foot wide and shall be paved.
 - The Design-Build Team shall adhere to the Roadside Design Guide in determining the length of need, flare rate and clear zone. In addition, the Design-Build Team shall adhere to the possible deflection of the proposed temporary barrier system in accordance with NCHRP-350 deflections from crash testing.
 - The Design-Build Team shall not place temporary barrier systems utilized for traffic control on unpaved surfaces.
5. The design speed for temporary alignments of NC, US and Interstate routes shall not be lower than the current posted speed limit.
 6. The lowest allowable design speed for temporary alignments on secondary roads shall be the higher of 10 mph below the posted speed limit or 35 mph.
 7. Roadway Standard Drawing 1101.11 shall be used for calculating the length of temporary merges for lane closures and temporary traffic shifts. All temporary alignments shall adhere to the *NCDOT Roadway Design Manual*, 2004 AASHTO *A Policy on Geometric Design of Highways and Streets* and the most current *Highway Capacity Manual*.
 8. Changes in pavement cross slopes shall only occur on a lane line or lane midpoint and shall not exceed 0.04.
 9. Maintain access to all residences, schools, emergency services and businesses at all times.

10. Traffic traveling in the same direction shall not be split (i.e. separation by any type of barrier, bridge piers, existing median, etc.).
11. Prior to incorporation, obtain written approval from the Engineer for all road closures.
12. The Design-Build Team shall not place I-85 or I-85 Business traffic on an offsite detour.
13. Prior to incorporation, all offsite detour routes shall be approved in writing by the Engineer and adhere to the following requirements:
- The Design-Build Team shall minimize the requests for offsite detours. All proposed offsite detours shall be included in the Technical Proposal providing justification for using such detours along with duration. Possible detour warrants could include, but are not limited to, road closures due to substandard horizontal or vertical clearance limits, grade changes at tie-in locations and oversize and / or overweight limits.
 - All detour routes shall be investigated, including but not limited to, analyzing traffic capacity, investigating impacts to emergency services and schools, analyzing design characteristics to ensure the design supports the traffic volumes, and investigating pavement structural adequacy.
 - The Design-Build Team shall determine and provide improvements required to accommodate detoured traffic prior to utilizing detour routes.
 - Offsite detours that have non-signalized at-grade railroad crossings shall not be allowed.
 - Submit the detour route and all associated sign designs for review and acceptance prior to incorporation.
14. On all roadways within the project limits, the Design-Build Team shall provide safe access for wide-loads and oversized permitted vehicles through the work zone. Safe access shall entail, but is not limited to, a sufficient pavement structure (Reference the Pavement Management Scope of Work found elsewhere in this RFP), required vertical clearance and minimum clear widths as follows:

Roadway	Minimum Clear Width
I-85	20 feet
All other roadways, including all ramps and loops	18 feet

15. The Design-Build Team shall utilize Changeable Message Signs (CMS) as follows :
- Provide a minimum of two (2) CMS's and operate when needed to display messages pertinent to work zone conditions information, including but not limited to, construction activities within the project limits and general traffic information.
 - In addition to the above requirements, the Design-Build Team shall provide and operate a minimum of two additional (2) CMSs per direction to display alternate route information (i.e. road closures, traffic detours, public information). The location of these CMS's will be determined by the operations requiring the advance warning and approved by the Engineer. These CMS's shall be in addition to any other devices provided by the Department and operated by the Metrolina and/or Triad Traffic Management Centers (TMC). The Design-Build Team shall coordinate with the TMC Operations Engineer or other designee if and when alternate route or detour information needs to be displayed.
 - All CMSs on the project shall have the functionality to be controlled remotely by the TMCs and operated in the field by the Design-Build Team.
 - Alternate and/or detour routes, CMS locations and CMS messages shall be reviewed and approved by the Engineer prior to incorporation.
 - These CMSs shall be in addition to any other CMSs required by the Roadway Standard Drawings.
 - Coordinate with the I-2304AC Design-Build Team when determining use, placement, messaging and number of CMSs to be used during a time period.
 - The Design-Build Team shall show approximate CMS locations, along with the respective messages that have been coordinated with the TMCs, in the Traffic Management Plans.
16. The Design-Build Team shall provide a smooth pavement surface for traffic at all times. For example, but not limited to, the Design-Build Team shall not place traffic on lanes containing rumble strips.
17. The Design-Build Team shall make all modifications to existing pavement markings, markers and signing located outside the project limits on all roads that are necessitated by the Traffic Management Plans.
18. The Design-Build Team shall take steps to minimize disruptions to existing roadway facilities during construction and shall demonstrate how the traffic control phasing minimizes inconvenience to the motorist on all roads.
19. For all areas affected by construction, the Design-Build Team shall develop and submit to the Engineer for approval a Congestion and Incident Management Plan. The plan shall include coordination with emergency response providers such as law enforcement, fire, and EMS services. This plan shall also include project contact

- information, potential detour routes, towing services, and other associated information.
20. The Design-Build Team shall investigate pedestrian facilities and maintain facilities during construction.
 21. The I-2304AD Design-Build Team shall coordinate with the I-2304AC Design-Build Team to maintain safe traffic operation at all times on I-85 during construction of these two projects.

B. Traffic Management Plan requirements:

The Design-Build Team shall select a Private Engineering Firm (PEF) that has experience designing and sealing Traffic Management Plans for the North Carolina Department of Transportation (NCDOT) on comparable projects. The Design-Build Team shall list projects in the Technical Proposal that the Traffic Management Designer has developed. This list shall include a description and similarity to the subject project.

The Design-Build Team shall develop Traffic Management Plans that maintains all types of traffic (motorists, bicyclists, and pedestrians within the highway, including persons with disabilities in accordance with the Americans with Disabilities Act of 1990 (ADA), Title II, Paragraph 35.130) as defined by the *Manual for Uniform Traffic Control Devices (MUTCD)*.

The Traffic Management Plans shall adhere to the “Design-Build Submittal Guidelines” and the “Guidelines for Preparation of Traffic Control and Pavement Marking Plans for Design-Build Projects”, which by reference are incorporated herein and are a part of the contract. These documents are available on the Design-Build website.

The Work Zone Traffic Control web site contains useful information that may be needed for the design of the Traffic Management Plans:

<http://www.ncdot.org/doh/preconstruct/wztc/>

The Staging Concept shall meet the Contract requirements before the first phase submittal can be submitted. Construction shall not begin until the first phase submittal meets the requirements of the contract and is accepted. Construction shall not begin on subsequent phase submittals until they meet the requirements of the Contract. Any changes to the staging concept after acceptance will require a submittal for review prior to any future phasing submittals can be submitted. All submittals shall follow the 2006 NCDOT Roadway Standard Drawings, 2006 Standard Specifications for Roads and Structures, the “Guidelines for Preparation of Traffic Control and Pavement Marking Plans for Design-Build Projects”, *Manual for Uniform Traffic Control Devices*, and the “Design-Build Submittal Guidelines”.

II. Project Operations Requirements

The following are Time Restrictions and notes that shall be included with the Traffic Management Plans General Notes, unless noted otherwise elsewhere in this RFP:

Time Restrictions

1. Intermediate Contract Time #1 and #2 for Lane Narrowing, Closure, Holiday and Special Event Restrictions.

Except as permitted outside the time restrictions noted below, the Design-Build Team shall maintain the minimum number of lanes and lane widths noted in the Design Parameters above. When traffic is placed into the final pattern for any roadway, that will become the minimal existing traffic pattern and the following time restrictions shall still apply.

Road Name	Time Restrictions
I-85, I-85 Business, and all Ramps and Loops	Monday through Friday 6:00 a.m. to 8:00pm Saturday and Sunday 11:00am to 8:00pm
All other -Y- Lines, including all Service Roads	Monday through Friday 6:00 a.m. to 9:00 a.m. and 4:00 p.m. to 6:00 p.m.

The Design-Build Team shall not install, reset, and / or remove any traffic control device during the times listed above.

In addition to the lane narrowing and closure restrictions stated above for all roads, during holidays, holiday weekends, special events, or any other time when traffic is unusually heavy on the roadways listed herein as directed by the Engineer, the Design-Build Team shall not close or narrow a lane of traffic, detain the traffic flow or alter the traffic flow on the aforementioned facilities. These restrictions include narrowing and closing shoulders unless an approved temporary traffic barrier is present on the shoulder. As a minimum, these requirements / restrictions apply to the following schedules:

- (a) For New Year's between the hours of 6:00 a.m. December 31st to 8:00 p.m. January 3rd. If New Year's Day is on a Friday, Saturday, Sunday or Monday then from 6:00 a.m. December 31st until 8:00 p.m. the following Tuesday.

- (b) For Easter, between the hours of 6:00 a.m. the Friday before Easter and 8:00 p.m. the Tuesday after Easter.
- (c) For Memorial Day, between the hours of 6:00 a.m. the Friday before Memorial Day to 8:00 p.m. the Tuesday after Memorial Day.
- (d) For Independence Day, between the hours of 6:00 a.m. July 3rd and 8:00 p.m. July 6th. If Independence Day is on a Friday, Saturday or Sunday, between the hours of 6:00 a.m. the Thursday before Independence Day and 8:00 p.m. the Tuesday after Independence Day.
- (e) For Labor Day, between the hours of 6:00 a.m. the Friday before Labor Day to 8:00 p.m. the Tuesday after Labor Day.
- (f) For Thanksgiving, between the hours of 6:00 a.m. the Tuesday before Thanksgiving to 8:00 p.m. the Tuesday of the following week.
- (g) For Christmas, between the hours of 6:00 a.m. the Friday before the week of Christmas Day and 8:00 p.m. the following Tuesday after the week of Christmas Day.
- (h) For any NASCAR event at the Charlotte Motor Speedway, between the hours of 6:00 a.m. the Wednesday before the 1st track event, until 8:00 p.m. the day after the last track event.
- (i) For any Carolina Panthers game in Charlotte, six (6) hours before the game and six (6) hours after the game.
- (j) For ACC Tournament between the hours of 6:00 a.m. the Tuesday of the week of the Tournament until 8:00 p.m. the following Monday after the Tournament.

Liquidated Damages for Intermediate Contract Time #1 for the above lane narrowing, lane closure, holiday and special event time restrictions for I-85 and I-85 Business including ramps / loops are \$5,000.00 per 30-minute period or any portion thereof.

Liquidated Damages for Intermediate Contract Time #2 for the above lane narrowing, lane closure, holiday and special event time restrictions for all other -Y- Lines and all Service Roads are \$500.00 per 30-minute period or any portion thereof.

2. Intermediate Contract Time #3 and #4 for Road Closure Restrictions for Construction Operations.

As a minimum, the Design-Build Team shall maintain the existing traffic pattern for all roadways and follow the road closure restrictions listed below. When a road

closure is used, the Design-Build Team shall reopen the travel lanes by the end of the road closure duration to allow the traffic queue to deplete before re-closing the roadway.

The Design-Build Team shall not close any direction of travel for the following roads during the times noted below. Closure of these roads or any ramps shall only be allowed for the operations listed in this intermediate contract time restriction:

Road Name	Time Restrictions
I-85, I-85 Business, and all ramps and loops	Sunday to Saturday - 6:00 a.m. to 12:00 a.m. (midnight)
All other -Y- Lines, including all Service Roads	Sunday to Saturday - 6:00 a.m. to 8:00 p.m.

Maximum road closure duration of **30 minutes** shall be allowed for the roadways listed in this ICT for the following operations:

- Traffic shifts to complete tie-in work and placement of pavement markings and markers
- Girder installation or removal of existing girders
- Installation of overhead sign assemblies and / or work on existing overhead sign assemblies over travel lanes
- Drainage construction that cannot be accomplished utilizing a lane closure and/or flagging operation

During an approved offsite detour for roads, the day and time restrictions do not apply. The duration of the road closure, listed in the Technical Proposal, will be used to determine the date and time the road will be reopened. This date and time will be used to access liquidated damages according to ICT #4.

Proposed road closures for any road within the project limits shall be approved by the Engineer prior to incorporation in the Traffic Management Plans.

Liquidated Damages for Intermediate Contract Time #3 for the above road closure time restrictions for I-85 and I-85 Business including ramps / loops is \$2500.00 per 15-minute period or any portion thereof.

Liquidated Damages for Intermediate Contract Time #4 for the above road closure time restrictions for all other -Y- Lines and all Service Roads is \$500.00 per 15-minute period or any portion thereof.

Hauling Restrictions

The Design-Build Team shall adhere to the hauling restrictions noted in the NCDOT 2006 *Standard Specifications for Roads and Structures*.

The Design-Build Team shall conduct all hauling operations as follows:

- The Design-Build Team shall not haul against the flow of traffic of an open travelway unless an approved temporary traffic barrier or guardrail separates the traffic from the hauling operation.
- The Design-Build Team shall not haul during the holiday and special events time restrictions listed in Intermediate Contract Time #1, unless the hauling operation occurs completely behind temporary traffic barrier or guardrail and does not impact I-85 or I-85 Business traffic operations.
- Haul vehicles shall not enter and / or exit an open travel lane at speeds more than 10 mph below the posted speed limit.
- Hauling access to the I-85 median will be allowed at the beginning and end of the project and from the existing Clark Road bridge. Using this bridge for hauling to the median is subject to lane closure time restrictions of ICT #2 if open to traffic. Once this interchange is closed permanently to traffic by the I-2304AC Design-Build Team, this hauling restriction will no longer apply.
- All entrances and exits for hauling to and from the work zone shall follow the Roadway Standard Drawings.
- Roads used as hauling access points to the I-85 median shall be limited to one per direction. Locations chosen by the Design-Build Team and approved by the Department. Hauling entrances, exits and crossing shall be shown on the Transportation Management Plan.
- The following hauling time restrictions apply only where egress and / or ingress occur between the work areas and any travel lane of the roads noted below, this includes hauling across roadways. Hauling operations that are conducted entirely behind a temporary traffic barrier or guardrail are allowed at all times and are excluded from the following time restrictions:

For Single Vehicle Hauling

Road Name	Day and Time Restrictions	
-L- (I-85), I-85 Business and all ramps and loops	6:00 a.m. to 9:00 a.m. and 3:00 p.m. to 8:00 p.m	Monday - Friday

For Multi-Vehicle Hauling

Road Name	Day and Time Restrictions	
-L- (I-85), I-85 Business and all ramps and loops	6:00 a.m. to 8:00 a.m. 11:00 a.m. to 8:00 p.m.	Monday - Friday Saturday and Sunday

Hauling across a roadway will require Traffic Control and is subject to the time restrictions listed in ICT #1 and ICT #2.

The Design-Build Team shall address how hauling will be conducted in the Technical Proposal, including but not limited to, hauling of materials to and from the site and hauling of materials within NCDOT right of way.

The Design Build Team shall monitor peak periods during construction and minimize hauling during these times beyond the times listed above.

B. Lane and Shoulder Closure Requirements

The Design-Build Team shall not install more than three (3) miles of lane closures in each direction of a multilane divided roadway within the project limits or in conjunction with this project, measured from the beginning of the merge taper to the end of the lane closure.

On multilane facilities, the Design-Build Team shall not install more than one simultaneous lane closure, in any one direction.

The Design-Build Team shall remove lane closure devices from the lane when work is not being performed behind the lane closure or when a lane closure is no longer needed.

When personnel and / or equipment are working within 15 feet of an open travel lane, the Design-Build Team shall close the nearest open shoulder using NCDOT *2006 Roadway Standard Drawing* No. 1101.04, unless the work area is protected by an approved temporary traffic barrier or guardrail.

When personnel and / or equipment are working on the shoulder adjacent to an undivided facility and within 5 feet of an open travel lane, the Design-Build Team shall close the nearest open travel lane using NCDOT *2006 Roadway Standard Drawing* No. 1101.02, unless the work area is protected by an approved temporary traffic barrier or guardrail.

When personnel and / or equipment are working on the shoulder adjacent to a divided facility and within 10 feet of an open travel lane, the Design-Build Team shall close the nearest open travel lane using NCDOT *2006 Roadway Standard Drawing* No. 1101.02, unless the work area is protected by an approved temporary traffic barrier or guardrail.

When personnel and / or equipment are working within a lane of travel of an undivided or divided facility, the Design-Build Team shall close the lane using the appropriate roadway standard drawing from the NCDOT *2006 Roadway Standard Drawings*. The Design-Build Team shall conduct the work so that all personnel and / or equipment remain within the closed travel lane.

The Design-Build Team shall not perform work involving heavy equipment within 15 feet of the edge of travelway when work is being performed behind a lane closure on the opposite side of the travelway.

C. Pavement Edge Drop off Requirements

The Design-Build Team shall backfill at a 6:1 slope up to the edge and elevation of the existing pavement and / or use proper traffic control setup to protect traffic from the drop off as follows:

- Elevation differences that exceed 2 inches on roadways with posted speed limits of 45 mph or greater and a paved shoulder that is four-foot wide or less.
- Elevation differences greater than 3 inches on roadways with posted speed limits less than 45 mph and with a paved shoulder that is four-foot wide or less.
- Refer to the *2002 AASHTO Roadside Design Guide* for proper treatment of all other conditions.

Do not exceed a difference of 2 inches in elevation between open lanes of traffic for nominal lifts of 1.5 inches. Install advance warning “UNEVEN LANES” signs (W8-11) 1000 feet in advance and a minimum of every half mile throughout the uneven area.

D. Traffic Pattern Alterations

The Design-Build Team shall notify the Engineer in writing at least twenty-one (21) calendar days prior to any traffic pattern alteration. (Reference the Public Information Scope of Work for public information requirements.)

E. Signing

The Design-Build Team shall install advance work zone warning signs when work is within 100 feet from the edge of travel lane and no more than three days prior to the beginning of construction.

When no work is being conducted for a period longer than one week, the Design-Build Team shall remove or cover all advance work zone warning signs, as directed by the Engineer. Stationary work zone warning signs shall be covered with an opaque material that prevents reading of the sign at night by a driver traveling in either direction.

When portable signs not in use for periods longer than 30 minutes, the Design-Build Team shall lay the portable work zone sign flat on the ground and collapse the sign stand and lay it flat on the ground.

The Design-Build Team shall be responsible for the installation and maintenance of all detour signing. The Design-Build Team shall cover or remove all detour signs within and off the project limits when a detour is not in operation.

The Design-Build Team shall ensure proper signing (including but not limited to guide signs) are in place at all times during construction, as required by the *MUTCD*.

F. Traffic Barrier

The Design-Build Team shall use only an NCDOT approved temporary traffic barrier system and adhere to the following requirements.

Install temporary traffic barrier system a maximum of two (2) weeks prior to beginning work in any location. Once the temporary traffic barrier system is installed at any location, proceed in a continuous manner to complete the proposed work in that location.

Once the temporary traffic barrier system is installed and no work has been or will be performed behind the temporary traffic barrier system for a period longer than two (2) months, remove / reset the temporary traffic barrier system unless the barrier is protecting traffic from a hazard.

Protect the approach end of temporary traffic barrier system at all times during the installation and removal of the barrier by either a truck mounted impact attenuator (maximum 72 hours) or a temporary crash cushion.

Protect the approach end of temporary traffic barrier system from oncoming traffic at all times by a temporary crash cushion unless the approach end of temporary traffic barrier system is offset from oncoming traffic as follows:

Posted speed limit (MPH)	Minimum offset (feet)
40 or less	15
45 - 50	20
55	25
60 mph or higher	30

Install temporary traffic barrier system with the traffic flow, beginning with the upstream side of traffic. Remove the temporary traffic barrier system against the traffic flow, beginning with the downstream side of traffic.

Install drums to close or keep closed tangent sections of the roadway until the temporary traffic barrier system can be placed or after the temporary barrier system has been removed. The distance, in feet, between drums shall be no greater than twice the posted speed limit (MPH).

At acceleration ramps / loops, install temporary traffic barrier system in a manner that provides a minimum of 200 feet from the end of the pavement marking taper to the beginning of the barrier taper.

The Design-Build Team shall be responsible for providing proper connection between the existing bridge rails and temporary barrier systems and include this information in the appropriate plans.

G. Traffic Control Devices

The Design-Build Team shall use traffic control devices that conform to all NCDOT requirements and are listed on the Approved Products List. The Approved Products List is shown on NCDOT's Work Zone Traffic Control website at <http://www.ncdot.org/doh/preconstruct/wztc/>. The use of any devices that are not shown on the Approved Product List shall require written approval from the Transportation Management Director.

In tangent sections, channelizing device spacing shall not exceed a distance in feet equal to twice the posted speed limit. At intersections and driveway radii, channelization devices shall be spaced 10 feet on-center and 3 feet off the edge of an open travelway, when lane closures are not in effect. Skinny drums shall only be allowed as defined in Section 1180 of the 2006 NCDOT *Standard Specifications for Roads and Structures*.

Place Type III barricades, with "ROAD CLOSED" signs (R11-2) attached, of sufficient length to close entire roadway. Stagger or overlap barricades to allow for ingress or egress.

When a CMS is placed within the clear zone, provide proper delineation and protection for the traveling public.

Place sets of three drums perpendicular to the edge of the travelway on 500-foot centers when unopened lanes are closed to traffic. These drums shall be in addition to channelizing devices.

H. Temporary Pavement Markings, Markers and Delineation

The Design-Build Team shall provide Temporary Pavement Marking Plans that meet the requirements of the RFP and the *Guidelines for Preparation of Traffic Control and Pavement Marking Plans for Design-Build Projects*.

The Design-Build Team shall use pavement marking and marker products that conform to all NCDOT requirements and are listed on the NCDOT Qualified Products List. The list is available at <http://www.ncdot.org/doh/preconstruct/traffic/congestion/sign/>. The use of any devices that are not shown on the Qualified Products List shall require approval from the Director of the Transportation Program Management Unit.

The Design-Build Team shall install pavement markings and markers in accordance with the NCDOT 2006 *Standard Specifications for Roads and Structures*, and in accordance with the manufacturer's procedures and specifications.

The Design-Build Team shall install temporary pavement markings that are the same width as existing pavement marking on all roadways. For roadways that do not have existing pavement marking, install temporary pavement markings that are the same width as required in the Pavement Marking Scope of Work for the final pavement marking.

The Design-Build Team shall install temporary pavement markings and temporary pavement markers on the interim surface or temporary pattern as follows:

Road	Marking	Marker
All Roads and Existing Structures	Minimum of Paint	Raised Temporary
Proposed Structures	Cold Applied Plastic (Type IV)	Raised Temporary

The Design-Build Team may use any type of pavement markings on the NCDOT Qualified Products List for temporary pattern. However, the Design-Build Team shall maintain a minimum retroreflectivity for pavement markings on all roads (existing and temporary marking) at all times during construction, as follows:

White:	125 mcd / lux / m ²
Yellow:	100 mcd / lux / m ²

When using Cold Applied Plastic (Type IV) pavement markings, place temporary raised markers half on and half off edgelines and centerlines to help secure the tape to the roadway. Markers shall be spaced the appropriate distance apart as described by the 2006 *Roadway Standard Drawing* 1250.01, Sheet 1 of 3.

Prior to opening a roadway to traffic on facilities that the installation of a proposed monolithic island has not occurred, outline the location of the proposed monolithic island with the proper color pavement marking.

Place at least 2 applications of paint for a temporary traffic pattern that will remain in place over three (3) months.

Tie proposed pavement marking lines to existing pavement marking lines.

Replace any pavement markings that have been damaged by the end of each day's operation.

The Design-Build Team shall not place temporary markings on any final asphalt pavement surface unless the temporary markings are placed in the exact location of the final pavement marking.

The Design-Build Team shall remove all conflicting markings or markers prior to shifting traffic to a new pattern.

Unless noted otherwise in this RFP, removal of the temporary pavement markings on asphalt surfaces shall be accomplished by an NCDOT approved system to minimize damage to the road surface. All temporary pavement markings on concrete pavement shall be removed by water blasting. Temporary pavement markings shall not be obliterated with any type of Black Pavement Markings (paint or other material). The Design-Build Team shall remove all temporary pavement markings without removing more than 1/32 -inch of the pavement surface.

I. Temporary Traffic Signals

Use the following notes if the Design-Build team recommends using temporary signals for maintenance of traffic.

- Notify the Engineer two months before a traffic signal installation by others is required.
- Shift and revise all signal heads as shown on the approved Design- Build signal plans.

J. Miscellaneous

Provide portable temporary lighting to conduct night work in accordance with the NCDOT 2006 *Standard Specifications for Roads and Structures*.

Provide proper drainage for all temporary alignments and / or traffic shifts.

Law enforcement officers shall be used to help protect workers and road users, and to maintain safe and efficient travel through the work zones. The Design-Build Team shall:

- Be responsible for coordinating with the law enforcement agency for the use of law enforcement officers.
- Use law enforcement officers during installation, operation and removal of lane closures on I-85.
- Use a minimum of one law enforcement officer per each lane closed.
- Only utilize officers who are outfitted with law enforcement uniforms and marked vehicles, which are equipped with proper lights mounted on top of the vehicle and agency emblems.

In the Technical Proposal, the Design-Build Team shall address where and how law enforcement officers will be used.

No Parking / Tow Away Zone signs shall be installed 1000 feet in advance of the *Begin Road Work* sign on all on-ramps within the project limits, and a minimum of every 3000 feet in each direction of I-85 within the I-85 widening project limits.

Coordinate with the NCDOT Resident Engineers in charge of any project in the vicinity of this project for any work that may affect the construction and the temporary traffic control of this project.

Coordinate with NCDOT Resident Engineers in charge of any project in the vicinity of this project to determine the placement of advance warning signs on all roads within the project limits.

A \$250 speeding penalty ordinance on I-85 during construction has been approved. Coordinate with the Engineer to ensure the placement of all speeding penalty signs are in their proper location.

A Work Zone Speed Limit Reduction Ordinance has been approved for I-85 and I-85 Business during lane closures. The Design Build Team is encouraged to use innovative methods to enhance compliance by motorists of the speed limit

The Design-Build Team shall be responsible for all required temporary shoring, including but not limited to providing, installing, maintaining and removing. Temporary shoring for the maintenance of traffic is defined as shoring necessary to provide lateral support to the side of an excavation or embankment parallel to an open travelway when a theoretical 2:1 (H:V) slope from the bottom of the excavation or embankment intersects the existing ground line closer than 5 feet from the edge of pavement of the open travelway. The Design-Build Team shall identify locations where “temporary shoring for maintenance of traffic” will be required on the Traffic Control Staging Concept. The Design-Build Team shall install temporary traffic barrier as shown on a detail available from the Work Zone Traffic Control Section. This detail provides design information on the temporary traffic barrier location in relation to the temporary shoring and traffic location. The NCDOT Geotechnical Engineering Unit and Work Zone Traffic Control Section websites have more information on temporary shoring. (Notes related to Temporary Shoring are not required in the General Notes sheet for the Traffic Management Plan)

<http://www.ncdot.org/doh/preconstruct/highway/geotech/formdet/standards.html>

<http://www.ncdot.org/doh/preconstruct/wztc/DesRes/English/TemporaryShoring/TempShoring.pdf>

The Design-Build Team shall adhere to the additional shoring requirements located on the Work Zone Traffic Control Section and Geotechnical Engineering Unit websites.

The Design-Build Team shall identify on the appropriate traffic control detail where temporary shoring will be used by providing station limits, offsets, the type of shoring and where temporary traffic barrier will be located if needed.

K. Traffic Control Supervisor

The Design-Build Team shall furnish a Traffic Control Supervisor for the project who is knowledgeable of **Transportation Management Plan** design, devices and application, and has full authority to ensure traffic is maintained in accordance with the plans and specifications.

The Design-Build Team shall identify a Traffic Control Supervisor in their Technical Proposal that has the following qualifications:

- (A) A minimum 24 months of On-the-Job Training in supervision and work zone set up and implementation on similar projects.
- (B) Be certified by responsible party (contractor or NCDOT) to have the required experience and training and is qualified to perform the duties of this position. If certified by the Contractor, a notarized certification letter shall be furnished to the Engineer at the preconstruction meeting. The letter shall state the Traffic Control Supervisor is qualified, and state that the Traffic Control Supervisor has the authority to ensure traffic is maintained in accordance with the contract documents.

The Traffic Control Supervisor for the project shall be **required to** perform the following:

- (1) Be available and on call at all times to direct / make any necessary changes in the traffic control operations in a timely and safe manner.
- (2) The Design Build Team shall provide the Engineer with back up contacts **that are given the same authority** for times when the Traffic Control Supervisor is not available at the project.
- (3) Coordinate and cooperate with traffic control supervisors of adjacent, and overlapping construction projects, as well as construction projects in proximity to the subject project, to ensure safe and adequate traffic control setup is maintained throughout the project at all times, including periods of construction inactivity.
- (4) Coordinate and cooperate with Rowan and Davidson County Maintenance Engineer, **the I-2304AC Design-Build Team, law enforcement and other necessary personnel** in the event of a serious backup or incident on I-85.
- (5) Coordinate and cooperate with personnel at the Metrolina and Triad Traffic Management Centers to ensure proper messages are displayed on the CMSs and DMSs.
- (6) Provide traffic control setup that ensures safe traffic operations and workers' safety throughout the construction area.
- (7) Attend all scheduled incident management, traffic control coordination, and team meetings, as required by the Engineer.
- (8) **Ensure regularly scheduled Traffic Operation and Safety Meetings are conducted in coordination with the Design-Build Team and the NCDOT Resident Engineer.**

- (9) Monitor traffic delays and backups within the work zone. Coordinate with the TMC as required by this Scope of Work. (Reference Design Parameter #15)

SIGNING SCOPE OF WORK (10-20-10)**General**

The Design-Build Team shall prepare the Signing Plans in accordance with the latest edition of the *2009 Manual on Uniform Traffic Control Devices (MUTCD)*, the *2004 NC Supplement to the MUTCD*, *NCDOT Standard Specifications for Roads and Structures* (July 2006), the NCDOT Roadway Standard Drawings (July 2006) for the design and development of Signing Plans, the latest Standard Specifications for *Structural Supports for Highway Signs, Luminaires, and Traffic Signals* published by AASHTO, “*Guidelines for Preparation of Signing Plans for Design-Build Projects*”, the “*Design-Build Submittal Guidelines*” and the contract requirements contained herein.

Signing Plan Requirement

The Design-Build Team shall select a Private Engineering Firm (PEF) that has experience in designing and sealing Signing Plans for NCDOT on projects comparable to this project. The Technical Proposal shall list projects including description and similarity to the subject project, that the PEF developed Signing Plans.

Signs Furnished by Design-Build Team

The Design-Build Team shall furnish signs in accordance with the specifications provided by the NCDOT.

Signing Project Limits

Unless noted otherwise elsewhere in this RFP, the Design-Build Team shall design Signing Plans for this project as if the I-2304AC Project was open to traffic. The Design-Build Team shall be responsible for the design, fabrication and installation of all signs required through the construction limits of the mainline, all -Y- Lines and all service roads. The Design-Build Team shall also be responsible for the design, fabrication and installation of all signs required beyond the construction limits of the mainline, all -Y- Lines and service roads to ensure adequate advance signage and spacing is provided.

The posted speed limits for this facility shall be 65 MPH.

Sign Design

The Design-Build Team shall be responsible for all Type A, B, and D sign designs, fabrication and installation for ground mounted signs. The Design-Build Team shall be responsible for sizing, fabricating, locating and installing all Type E (warning and regulatory signs), Type F signs (route marker assemblies) and milemarkers. The milemarker designs shall be in accordance with the Intermediate Enhanced Reference Location Signs (D10-4) referenced in the *Standard Highway Signs* (2004 Edition).

The Design-Build Team shall design, fabricate and install Thru Bolts for Type “A” Signs in accordance with the revised NCDOT Roadway Standard Drawing No. 901.10 dated January 2008. The revised Roadway Standard Drawing is located at the following website:

<http://www.ncdot.org/doh/preconstruct/traffic/congestion/SIGN/signstd/>

All sign designs shall be included in the Signing Plans. All sign designs shall be prepared using the latest version of GudeSign software. The latest GuideSign updates are located at the following website:

<http://www.ncdot.org/doh/preconstruct/traffic/congestion/SIGN/default.html>

Logo Signs

The Design-Build Team is not responsible for designing, locating, or installing any new Logo signs (blue service signs with specific business panels included on signs); however, the Design-Build Team shall be responsible for relocating existing Logo signs upon completion of the widening, realignment, or other construction procedures.

Sign Maintenance

The Design-Build Team shall maintain all existing signs during construction, including temporary installations of Guide and Logo Signs on supports to ensure signs are properly maintained and visible during project construction. If damage occurs to the Logo Signs or the business panels during construction or installation, the Design-Build Team shall notify the Division Logo Coordinator as soon as possible. The Design-Build Team shall be responsible for replacement of Logo Signs or Logo business panels should damage occurs. If the Logo Signs are removed and disposed of per the RFC Signing Plans, the business panels on the signs shall be removed and returned to the Division Logo Coordinator. The order of preference for Logo Signs shall be maintained during project construction (Reference MUTCD - Section 2F.02).

Temporary Signs

The Design-Build Team shall be responsible for designing, fabricating, and installing temporary signs and supports. (Reference the Signing Section of the Traffic Management Scope of Work found elsewhere in this RFP for additional temporary signing requirements.)

Sign Locations

The Design-Build Team shall be responsible for determining the station locations for all signs. To avoid sign placement in locations where their usefulness will be short-lived, the Design-Build Team shall coordinate the proposed sign designs and locations with existing and future projects through the Department.

Ground Mounted Support Designs

NCDOT will provide the software for ground mounted sign support designs. The Design-Build Team shall be responsible for all design, fabrication and installation of ground mounted supports and signs. Instructions for loading support design software will be made available upon request.

Exit Gore signs shall be erected on omni-directional breakaway supports.

Overhead Sign Assemblies

The Design-Build Team shall design, fabricate and install overhead sign assemblies that meet all Department requirements. The windspeed for the overhead sign assembly designs shall be 90 mph. The Design-Build Team shall be responsible for calculating the windload area for the overhead sign assembly. The windload area shall be flush with the sign height and width. When calculating the windload area, the Design-Build Team shall include exit panels as part of the sign height. The coordination with future projects and sign messages shall be considered when designing and fabricating overhead sign assemblies.

The minimum vertical clearance beneath all overhead sign assemblies shall be 17 feet. The Design-Build Team shall submit written verification of the actual vertical clearance of overhead sign structures.

The Design-Build Team shall design, fabricate, and install overhead and pedestal sign supports and foundations in accordance with the Overhead Sign Supports and Overhead Sign Foundations Project Special Provisions found elsewhere in this RFP.

When applicable, the Design-Build Team has the option to mount signs vertically centered on the horizontal member of the overhead structure or to locate the bottom edge of all signs on each assembly in a horizontal plane.

Lighting will not be required on overhead sign assemblies.

At a minimum, the Design-Build Team shall provide the following I-85 northbound Overhead Sign Assemblies:

- Belmont Road – One mile Advance Guide Sign
- Belmont Road – Exit Directional
- I-85 Business – A series of three Lane Control Signs

At a minimum, the Design-Build Team shall provide the following I-85 southbound Overhead Sign Assemblies:

- NC 150 – Two Advance Guide Signs
- Belmont Road – Two Advance Guide Signs
- Belmont Road – Exit Directional

Pedestal Overhead Sign Assemblies Option

For multi-lane facilities, the Design-Build Team has the option to design pedestal overhead sign assemblies or cantilever overhead sign assemblies for advance guide signs only. Pedestal overhead sign assemblies shall not be allowed for signs with “EXIT ONLY” designations. Exit directional signing shall be mounted on cantilever overhead sign assemblies over the appropriate lane(s). The Design-Build Team shall clearly indicate in their Technical Proposal their intention to provide pedestal overhead sign assemblies for advance guide signs.

All pedestal overhead sign assemblies shall have a 20-foot maximum offset from the edge of pavement to the centerline of the support. The Design-Build Team shall install guardrail or other approved positive protection barrier.

Overhead Sign Supports for Freeways

Overhead sign supports shall be located a minimum of 40 feet from the edge of the outside travel lane to the center of the sign support. If the minimum 40-foot distances cannot be obtained, the overhead sign supports shall be located a minimum of 20 feet from the outside travel lane and protected by guardrail or other NCDOT approved positive protection barrier.

The Design-Build Team shall provide the appropriate positive protection and drainage for all overhead sign median supports.

Overhead Sign Sheeting

The Design-Build Team shall design and fabricate overhead signs using Type VIII, IX, or XI reflective sheeting for the legends, text and shields. The sheeting type selected by the Design-Build Team shall be consistent throughout the project.

DMS Installation

The Design-Build Team shall furnish and install one new pedestal mounted Dynamic Message Sign (DMS) assembly, including but not limited to, furnishing and installing a DMS enclosure, pole mounted equipment cabinet, pedestal mounted structure, electrical service equipment, conduit, wireless communication and feeder conductors on southbound I-85 near MM 86 in Davidson County.

The Design-Build Team shall remove and dispose of the existing overhead DMS structure, structure foundations, base mounted equipment cabinet and foundation located on southbound I-85 at MM 86. All work shall comply with the Dynamic Message Sign Project Special Provision.

The Design-Build Team shall remove and deliver the existing DMS enclosure to the Metrolina Regional Transportation Management Center in Charlotte, NC.

Guardrail or Other Protection for Signs and Overhead Assemblies

The Design-Build Team shall be responsible for determining, designing and installing any protection for proposed and existing sign supports. Guardrail protection for overhead assembly foundations in the median shall allow access through guardrail for mowing operations.

Signing Roadway Standards, Typical Sheets and Specifications

Signing roadway standards and typical sheets to be used in summarizing quantities, standard specifications, and compiling Type E and F signs can be located at the following website:

<http://www.ncdot.org/doh/preconstruct/traffic/congestion/SIGN/default.html>

The Design-Build Team shall incorporate the appropriate information onto these sheets and submit them to the Transportation Program Management Director for review and acceptance.

Removal and Disposal of Existing Signs

The Design-Build Team shall be responsible for determining those existing signs that will no longer be needed upon completion of the project, such as on -Y- Lines and project tie-ins. The Design-Build Team shall be responsible for the removal and disposal of these signs and supports. The Design-Build Team shall show and note these signs on the signing plan view sheets.

Construction Revisions

After submittal of RFC Signing Plans, all construction revision shall be submitted to the Department for review and acceptance prior to incorporation.

PAVEMENT MARKINGS SCOPE OF WORK (10/20/2010)**General**

The Design-Build Team shall prepare Final Pavement Marking Plans in accordance with the latest edition of the *Manual on Uniform Traffic Control Devices (MUTCD)*, the NCDOT Roadway Standard Drawings (July 2006), “*Guidelines for Preparation of Traffic Control and Pavement Marking Plans for Design-Build Projects*”, and the “*Design-Build Submittal Guidelines*” and the contract requirements contained herein.

Final Pavement Marking Plan Requirements

The Design-Build Team shall select a Private Engineering Firm (PEF) that has experience designing and sealing Pavement Marking Plans for NCDOT on comparable projects. The Design-Build Team shall list projects in the Technical Proposal, including description and similarity to the subject project that the PEF developed.

The Design-Build Team shall develop Pavement Marking Plans that maintain all types of traffic (motorists, bicyclists, and pedestrians within the highway, including persons with disabilities in accordance with the Americans with Disabilities Act of 1990 (ADA), Title II, Paragraph 35.130) as defined by the *Manual for Uniform Traffic Control Devices (MUTCD)*.

Final Pavement Marking Project Limits

The Design-Build Team shall modify existing pavement markings, markers and signing located outside the project limits to ensure that all four lanes in each direction are open to through traffic, including the area from the previous project, I-2304AC, to this project.

The Design-Build Team shall use permanent markings and markers to designate the tapering of the eight-lane section down to the existing six-lane section.

The Final Pavement Marking Plans shall address any required modifications to existing pavement markings located outside the project limits to ensure appropriate tie-ins. The Design-Build Team shall be responsible for installing all pavement markings and markers located within and outside the project limits, resulting from the project construction.

Pavement Markings, Markers and Delineation

The Design-Build Team shall not place any final pavement markings and markers until the Final Pavement Marking Plans are submitted for review and acceptance.

The Design-Build Team shall use pavement marking, marker and other delineation products that conform to all NCDOT requirements and are listed on the NCDOT’s Approved Products List. The use of any devices that are not shown on the Approved Product List shall require written approval from the Transportation Program Management Director.

The Design-Build Team shall install pavement markings and markers in accordance with the NCDOT 2006 *Standard Specifications for Roads and Structures*, and in accordance with the manufacturer's procedures and specifications.

The Design-Build Team shall install pavement markings and pavement markers on the final surface as follows:

Road	Marking	Marker
-L- Line and Ramps	6 in. Polyurea with Highly Reflective Elements	Snowplowable
-Y- Lines and Service Roads and Ramps	Thermoplastic	Permanent Raised
-Y- Lines Bridge Decks	Polyurea with standard beads or Cold Applied Plastic (Type II)	Permanent Raised

All Full Control of Access interstate facilities and US routes require 6-inch wide pavement markings, i.e., lane lines, edge lines and skips for the final pavement marking.

Using polyurea or epoxy pavement marking material, install black contrast markings on -L- Line skips in accordance with the Black-White Combination / 10' White Skip Lines / 10' Black Skip Lines Detail dated October 20, 2010. As applicable, provide epoxy pavement marking material in accordance with the Epoxy Pavement Material Project Special Provision.

Remove/Replace any conflicting/damaged pavement markings by the end of each day's operation.

Passing Zone(s) will be determined in the field and must be approved by the Engineer.

All stop bars at non-signalized intersections are to be located by the Design-Build Team.

Unless noted otherwise elsewhere in this RFP, removal of the temporary pavement markings shall be accomplished by using water blasting, grinding, shot blasting systems or other NCDOT approved systems to minimize damage to the road surface. Pavement markings on the final pavement surface shall not be removed with water blasting.

GEOENVIRONMENTAL SCOPE OF WORK (10-20-10)

The plans referred to herein as the I-2304AB Right of Way Plans provided by the Department are the hard copy of the Right of Way Plans distributed on October 21, 2010.

I. DEFINITION

For the purpose of this scope of work, contamination / contaminants are defined as any substance, which when discharged in any quantity may present an imminent and substantial danger to the public health or welfare. Petroleum is defined as any oil of any kind and in any form, including, but not limited to, crude oil, diesel fuel, fuel oil, gasoline, lubrication oil, oil refuse, oil mixed with other waste, oil sludge, petroleum related products or by-products, and all other liquid hydrocarbons, regardless of specific gravity, whether singly or in combination with other substances.

II. DESCRIPTION OF WORK

Two active gas stations with known soil contamination are within the project limits; Walser Enterprises property, NCDOT Parcel 21 and Ruby Hanes Property, NCDOT Parcel 35. The Design Build Team shall acquire no additional right of way on these two parcels beyond what is shown on the **I-2304AB Right of Way Plans provided by the Department** due to the contaminated soil and fuel supply tanks just outside the proposed right of way.

Two USTs were removed from an abandoned gas station on the former Larry C. Kines Property, NCDOT Parcel 32. Petroleum contamination remains at a depth of eight feet.

Contamination is not anticipated to be encountered during construction and any contamination will therefore be deemed as Unknown Contamination.

Right of Way Acquisition

If additional right of way is required on these two properties, the Department shall require 30 days to review the plans and provide right of way recommendations.

The Design-Build Team shall notify the Transportation Program Management Director in writing of any underground fuel, chemical, or heating oil tanks found during property appraisals. The Department shall require 30 days to investigate the property and provide right of way recommendations after receiving written notification from the Design-Build Team. The Department shall require 30 days to remove the fuel, chemical, and heating oil tanks from the property after receiving written notification from the Design-Build Team that the property has been acquired and the building has been razed.

III. INFORMATION PROVIDED BY NCDOT:

- Parcel 21, Walser Enterprises Parcel, Preliminary Site Assessment Report
- Parcel 32, former Larry C. Kines Parcel, Initial Abatement Action Report
- Parcel 35, Ruby Haynes Parcel, Preliminary Site Assessment Report

IV. UNKNOWN CONTAMINATED SITES:

The Design-Build Team shall immediately notify the Department when the Design-Build Team's operations encounter or expose any abnormal condition which may indicate the presence of a hazardous, contaminated, and / or toxic material not previously identified. If the Engineer elects to have the Design-Build Team remove and dispose of contaminated material within an unknown contaminated site, the removal and disposal of this material shall be performed in accordance with Article 107-26 of the 2006 NCDOT *Standard Provisions for Roads and Structures*.

In the unlikely event that contaminated soil must be disposed of, the Department will obtain the appropriate identification numbers and sign the shipping manifests as the generator.

UTILITIES COORDINATION SCOPE OF WORK (10-20-10)

The plans referred to herein as the I-2304AB Right of Way Plans provided by the Department are the hard copy of the Right of Way Plans distributed on October 21, 2010.

Background and Status

The Department has initiated the agreements and coordination of utility relocation plans and the physical relocation of utilities on the project. The Department will provide a Utility Coordination Transfer Report which identifies all known utilities in conflict with the project as well as the approximate location of each utility, prior rights information, current status of the agreement or relocation, and estimated date of clearing of the conflict.

The Department will continue this coordination effort until the contract for this project is executed, at which time the Design-Build Team shall take over the relocation responsibilities as outlined in this scope of work for all utilities, including utility installation for lighting and ITS.

The Design-Build Team shall obtain the services of a Private Engineering Firm (PEF) knowledgeable in the NCDOT Utility Coordination Process involved with utility relocation / installation and highway construction. The Design-Build Team shall be responsible for coordinating all utility relocations, removals, and / or adjustments where the Design-Build Team and Utility Company, with concurrence from the Department, determine that such work is essential for highway safety and performance of the required highway construction. Coordination shall be for all utilities whether or not they are specifically identified in this scope of work and shall include any necessary utility agreements when applicable. NCDOT will be the approving authority for all utility agreements and approval of plans.

Cost Responsibility

The Design-Build Team shall be responsible for all costs associated with relocating water and sewer facilities. The Design-Build Team shall also be responsible for all costs associated with relocating or adjusting any utilities that have already been relocated once, or have been authorized to be relocated, to accommodate the design shown on the **I-2304AB Right of Way Plans provided by the Department**.

Unless otherwise noted above, The NCDOT will be responsible for all other non-betterment utility relocation cost when the utility company has prior rights of way / compensable interest. The utility company shall be responsible for the relocation costs if they can not furnish evidence of prior rights of way or a compensable interest in their facilities. The Design-Build Team shall be responsible for determining the cost responsibility for the utility relocations. The Design-Build Team shall be responsible for all costs associated with utility relocations due to haul roads and / or any other temporary conditions resulting from the Design-Build Team's methods of operation or sequence of work. NCDOT will be the approving authority for all utility agreements and approval of plans.

Project Details

The Design-Build Team shall be responsible for verifying the utility locations, type of facilities, and identifying the utility owners in order to coordinate the relocation of any utilities, known and unknown, in conflict with the project. The following utilities are known to be located within the project construction limits:

Utility Owner	Utility Type	Cost Responsibility
Duke Energy (Trans.)	Power	NCDOT (Prior Rights)
Duke Energy (Dist.)	Power	NCDOT (Prior Rights)
Windstream Communications	Telephone (Buried)	Utility Owner
Windstream Communications	Telephone (Aerial)	NCDOT (Prior Rights)
Energy United	Power	NCDOT (Prior Rights)
Piedmont Cable	CATV	Utility Owner
Davidson County Water	Water and Sewer	NCDOT (G. S. 136-27)

Water and Sewer

If the Design-Build Team's design and / or construction requires the relocation of existing water or sewer facilities, designs shall be coordinated with the NCDOT Utility Coordination Unit. All costs associated with the design and construction for relocation of these existing water and / or sewer facilities shall be the responsibility of the Design-Build Team and shall be included in the lump sum bid for the project. The Design-Build Team shall develop designs; prepare all plans for needed agreements and permits; submit permits directly to the agencies and obtain approval from the agencies. The Design-Build Team shall be responsible for all permit fees.

Designs shall be coordinated with the NCDOT Utility Coordination Unit. The Design-Build Team shall be responsible for submitting five (5) sets of 11 x 17 utility construction drawings to the State Utility Agent, via the Transportation Program Management Director, for further handling. Each set shall include a title sheet, plan sheets, profiles and special provisions if required. Once approved by the State Utility Agent, the plans, with the appropriate agreement, will be sent out to Davidson County Water for their review and concurrence.

The relocation of all water and sewer facilities shall be done in accordance with the NCDOT policies and the latest Davidson County Water Inc. water and sewer design requirements / specifications. In the event of conflicting design parameters in the requirements noted above, the proposed design shall adhere to the most conservative values. The Design-Build Team may obtain the design requirements / specifications from the website noted below:

<http://www.davidsonwater.com/sitemap/sitemap.asp>

Utility Relocation Plans

In the event of a utility conflict, the Design-Build Team shall request that the utility company submit relocation plans (Highway Construction Plans to be provided by the Design-Build Team to Utility Owners) that show existing utilities and proposed utility relocations for approval by the NCDOT.

The Design-Build Team shall submit (3) three copies of the Utility Relocation Plans to the NCDOT State Utility Agent, via the Transportation Program Management Director, for review and approval prior to relocation work beginning. The Design-Build Team shall also be responsible for submitting the appropriate agreements to be used with the Utility Relocation Plans (See Agreements found elsewhere in this scope of work). After the review process is complete, the NCDOT Utility Coordination Unit will submit one (1) copy of the Utility Relocation Plans, executed agreements and any necessary comments back to the Design-Build Team. The NCDOT Utility Coordination Unit will also submit a copy of the approved Utility Relocation Plans to the Department's Resident Engineer. If the Utility Relocation Plans are approved subject to changes, it shall be the Design-Build Team's responsibility to coordinate these changes with the appropriate utility company.

Compensable Interest

Typically, affidavits, recorded easements or NCDOT agreements can serve as evidence of prior rights. A compensable interest is identified as follows:

- (A) Existing or prior easement rights within the limits of the project, either by recorded right of way or adverse possession (Utility occupying the same location for twenty (20) plus years outside the existing highway rights of way).
- (B) Entities covered under *General Statute 136-27.1* and *136-27.2*. Statute requires the NCDOT to pay the non-betterment cost for certain water, sewer and gas relocations.
- (C) Utilities that have a joint-use agreement that constitutes a compensable interest with entities that have existing or prior easements rights within the project limits.

Work Performed by Design-Build Team for Utility Owners

If the Design-Build Team elects to make arrangements with a Governmental Agency or any other utility owner for proposed utility construction, in which the Agency / Utility Owner shall be responsible for the costs of work to be performed by the Design-Build Team, the Design-Build Team shall be responsible for negotiating all costs associated with the proposed construction. Once the Design-Build Team and the Agency / Utility Owner agree on a plan and a lump sum estimated cost for the utility construction, the Design-Build Team shall be responsible for submitting five (5) sets of 11 x 17 utility construction drawings to the State Utility Agent, via the Transportation Program Management Director, for further handling. Each set shall include a title sheet, plan sheets, profiles and special provisions if required. Also, a letter from the Agency / Utility Owner agreeing to the plans and lump sum cost must accompany this package. The NCDOT will reimburse the Design-Build Team the estimated lump sum cost

under a Supplemental Agreement. The necessary Utility Agreement to the Agency / Utility Owner for reimbursement shall be a two party agreement between the NCDOT and the Agency / Utility Owner; and will be developed and executed by the Department.

If the Design-Build Team is requested, in writing, by a utility company to relocate facilities not impacted by the project's construction, and / or upgrade or incorporate new facilities as part of the highway construction, designs shall be coordinated with the Utility Owner and NCDOT Utility Coordination Unit. The associated design and construction costs shall be negotiated and agreed upon between the Design-Build Team and the utility company. The Design-Build Team shall develop designs; prepare all plans for needed agreements and permits; submit permits directly to the agencies and obtain approval from the agencies. The Design-Build Team shall be responsible for all permit fees.

Cable TV

The cost in relocating CATV due to the highway construction shall be the responsibility of the CATV Company; however, under the following conditions the Design-Build Team shall bear the relocation expense:

- (A) If the CATV Company can validate a recorded easement for facilities outside the maintained NCDOT rights of way.
- (B) The adjustment is needed on existing utility poles to accommodate a proposed NCDOT Traffic Management System Fiber Optic Communication Cable Project.

The NCDOT will not permit CATV to place poles within the highway rights of way but will allow down guys for their facilities within the highway rights of way. Under most circumstances, the CATV Company will continue a joint-use attachment with the local Power and Telephone Company. If the CATV proposed relocation places buried facilities within the highway rights of way then plans and encroachment agreements shall be required by the NCDOT.

Preparation for Communication Cables / Electrical Services for Lighting and ITS Devices:

Prior to establishing the location for new meter poles / boxes, the Design-Build Team shall coordinate with the local Power Distribution Company concerning accessibility of E/C Service and safety in maintenance of the meter.

Prior to installation, the Design-Build Team shall provide plans for review and approval for all service taps that require a parallel installation within the C/A.

Parallel service installation within a C/A shall be buried and located as close to the R/W line as practical. Only due to unusual circumstances will parallel aerial service installations within C/A be allowed. The Design-Build Team shall justify the allowance of parallel aerial service installation and obtain NCDOT approval prior to installation

The Design-Build Team shall be responsible for all coordination activities required for the utility company to provide service taps. Prior to the Design-Build Team developing the associated design and / or instructing the utility company to proceed with providing the service taps, the Design-Build Team shall obtain written approval of the service tap locations from the Resident Engineer. The Department will be responsible for construction costs associated with the utility company providing service taps.

General

The Design-Build Team shall not commence work at points where the highway construction operations are adjacent to utility facilities, until making arrangements with the utility company to protect against damage that might result in expense, loss, disruption of service or other undue inconvenience to the public or utility owner. The Design-Build Team shall be responsible for damage to the existing or relocated utilities resulting from the Team's operations. In the event of interruption of any utilities by the project construction, the Design-Build Team shall promptly notify the proper authority (Utility Company) and cooperate with the authority in the prompt restoration of service.

The Design-Build Team shall accommodate utility adjustments, reconstruction, new installation and routine maintenance work that may be underway or take place during the progress of the contract.

Utilities may not be attached to bridges on this project.

If total property acquisition is unavoidable due to encroachment into wells and / or septic systems, then the Design-Build Team shall investigate and determine if extending water and / or sewer lines to the affected property is cost effective. If the Department concurs with the determination that a utility extension is cost effective, the costs associated with the utility construction shall be addressed in accordance with Article 104-7 of the Standard Specifications.

The Design-Build Team shall be required to use the guidelines as set forth in the following:

- (A) *NCDOT Utility Manual - Policies & Procedures for Accommodating Utilities on Highway Rights of Way*
- (B) *Federal Aid Policy Guide - Subchapter G, Part 645, Subparts A & B*
- (C) *Federal Highway Administration's Program Guide, Utility Adjustments & Accommodations on Federal Aid Highway Projects*
- (D) *NCDOT Construction Manual Section 105-8*
- (E) *NCDOT Right of Way Manual - Chapter 16 Utility Relocations*
- (F) *NCDENR Public Water Supply - Rules governing public water supply*
- (G) *NCDENR Division of Water Quality - Title 15A - Environment and Natural Resources*

Agreements

If a utility company can provide evidence of prior rights of way or a compensable interest in their facilities, the Design-Build Team shall coordinate the non-betterment utility relocation cost with the utility company and develop the Utility Agreement. The Design-Build Team shall be required to utilize the NCDOT Three-Party Utility Relocation Agreement as required to relocate utilities.

The NCDOT State Utility Agent must execute approved agreements on Design-Build highway projects. The Utility Relocation Agreements (Cost Agreement) and encroachment agreements are available from the NCDOT Utility Coordination Unit. Reference Pages 59 and 60 of the *NCDOT Utility Manual on Policies & Procedures for Accommodating Utilities on Highway Rights of Way* for the different types of encroachment agreements available for use.

The Design-Build Team shall be required to utilize the NCDOT Standard Utility Encroachment Agreements as necessary in relocating utilities. The Encroachment Agreements shall be used under the following conditions:

- (A) If a utility company is not occupying a valid right of way / compensable interest and the proposed relocation will place the relocated utilities within the existing or proposed highway rights of way.
- (B) For **all** new utility installations within the existing or proposed highway rights of way. This includes all water, sewer and gas lines owned by entities covered under *General Statute 136-27.1* and *136-27.2*.
- (C) In either case above, the Design-Build Team shall submit 5 copies of the encroachment plans plus 2 originals and 3 copies of the encroachment agreement to the NCDOT State Utility Agent, via the Transportation Program Management Director, for approval.

RIGHT OF WAY SCOPE OF WORK (10-20-10)

The plans referred to herein as the I-2304AB Right of Way Plans provided by the Department are the hard copy of the Right of Way Plans distributed on October 21, 2010.

Unless noted otherwise elsewhere in this RFP, the Department has acquired all right of way, easements and control of access for the project as shown on the **I-2304AB Right of Way Plans provided by the Department**. In the event that additional right of way, easements and / or control of access are needed to construct the project beyond that which has already been acquired by the Department, the Design-Build Team shall acquire the additional right of way, easement and / or control of access in accordance with the provisions of this scope of work.

The cost of the right of way, easement and control of access, as shown on the I-2304AB Right of Way Plans provided by the Department, has been, borne by the Department. The cost of both the acquisition services and the actual cost of the right-of-way of any additional right of way, easements and / or control of access as required by the Design-Build Team's design or construction methods, beyond that shown on the I-2304AB Right of Way Plans provided by the Department, shall be the responsibility of the Design-Build Team. There are three exceptions to this paragraph:

1. If the Design-Build Team demonstrates to the Department's satisfaction that the project cannot be constructed, or utilities relocated / constructed, within the right of way, easements and / or control of access as shown on the **I-2304AB Right of Way Plans provided by the Department**, the Department will bear the cost for the portion of the additional right of way, easement and / or control of access that is satisfactorily demonstrated by the Design-Build Team as needed to construct the facility.
2. The Department is in the process of acquiring the required additional five-foot Permanent Utility Easement (PUE) width required on the parcels noted below. The Department will finalize the PUE acquisition process for these parcels by April 1, 2011. The Department shall not honor any requests for additional contract time or compensation, including idle equipment or mobilization or demobilization costs, associated with completion of the PUE acquisition process. The cost associated with finalizing these acquisitions, as well as the easement costs, will be borne by the Department.

Parcel Nos. – 14, 15, 17, 18, 19, 24, 26, 27, 31, 32, 34, 35, 36, 37, 38, 38A, 39, 40, 43, 46 and the Frank C. Stokes, Et al parcel (DB 1086 – Pg. 730)

3. In proximity to Old Salisbury Road (Old US 29 – US 70), the Department may not have acquired adequate right of way and / or easement for the required Belmont Road realignment. If the Design-Build Team's design and / or construction methods for this realignment require additional right of way and / or easement, the Design-Build Team should expect it to take three months for the Department to complete the acquisition process. This three-month timeframe shall begin with the Department's acceptance of the Right of Way Plans developed by the Design-Build Team. If the right of way acquisition process is completed within the timeframe noted above, or if the Design-Build Team

cannot adequately demonstrate that this additional right-of-way in on the project's critical path, the Department will not honor any requests for additional contract time or compensation, including idle equipment or mobilization or demobilization costs, associated with completion of this acquisition process. The cost associated with the acquisition process, as well as the right of way and easement costs, will be borne by the Department. (Reference the Roadway Scope of Work found elsewhere in this RFP)

As shown on the I-2304AB Right of Way Plans provided by the Department, the NCDOT will be responsible for the removal and disposal of all buildings and appurtenances for the project. The Design-Build Team shall be responsible for all costs associated with the removal and disposal of all additional buildings and appurtenances required by the Design-Build Teams design or construction methods, beyond that shown on the Right of Way Plans developed by the Department.

For all additional right of way, easements and / or control of access required by the Design-Build Team's design or construction methods, beyond that shown on the I-2304AB Right of Way Plans provided by the Department, the Design-Build Team shall carry out the following responsibilities:

- The Design-Build Team shall employ qualified, competent personnel who are currently **approved by the NCDOT Right of Way Branch** to provide all services necessary to perform all appraisal, appraisal review, negotiation and relocation services required for completion of the project in accordance with G.S. 136-28.1 of the General Statutes of North Carolina, as amended, and in accordance with the requirements set forth in the *Uniform Appraisal Standards and General Legal Principles for Highway Right of Way*, the *North Carolina Department of Transportation's Right of Way Manual*, the *North Carolina Department of Transportation's Rules and Regulations for the Use of Right of Way Consultants*, the *Code of Federal Regulations*, and *Chapter 133 of the General Statutes of North Carolina from Section 133-5 through 133-18*, hereby incorporated by reference, including the Uniform Relocation Assistance and Real Property Acquisition Policies Act of 1970, as amended. The Design-Build Team shall perform the services as set forth herein and furnish and deliver to the Department reports accompanied by all documents necessary for the settlement of claims and the recordation of deeds, or necessary for condemnation proceedings covering said properties.
- A Department representative will be available to provide technical guidance on right of way acquisition procedures and to make timely decisions on approving relocation benefits and approving administrative adjustment settlements on behalf of the Department over and above the authority granted to the Department Right of Way Consultant Project Managers.
- The Design-Build Team shall submit a right of way project tracking report and right of way quality control plan to the Department. The Department standard forms and documents will be used to the extent possible.

- The Design-Build Team shall provide a current title certificate for each parcel they acquire as of the date of closing or the date of filing of condemnation, unless required otherwise in the Department's Right of Way Manual.
- The Design-Build Team shall prepare all Final Condemnation Reports.
- The Design-Build Team shall prepare, obtain execution of and record documents conveying title to acquired properties to the Department with Register of Deeds and deliver all executed and recorded deeds and easements to the Department. For all property purchased in conjunction with the project, title will be acquired in fee simple or easement and shall be conveyed to "The North Carolina Department of Transportation", free and clear of all liens and encumbrances except permitted encumbrances.
- It is understood and agreed by and between the parties hereto that all reports, surveys, studies, specifications, memoranda, estimates, etc., secured by and for the Design-Build Team shall become and remain the sole property of the Department upon termination or completion of the work, and the Department shall have the right to use same for any public purpose without compensation to the Design-Build Team.
- The Design-Build Team shall prepare appraisals in accordance with The Department's *Uniform Appraisal Standards and General Legal Principles for Highway Right of Way Acquisitions*. The Design-Build Team's appraiser must be on The Department's approved state certified appraiser list. The Design-Build Team may request its state certified appraiser be added to the approved state certified appraiser list, subject to approval by the Department's State Appraiser.
- The Design-Build Team shall provide appraisal reviews complying with the Department's *Uniform Appraisal Standards and General Legal Principles for Highway Right of Way Acquisitions*. The reviewer must determine that the appraisal meets the Department's guidelines and requirements, conforms to acceptable appraisal standards and techniques, does not include any non-compensible items or exclude any compensible items and that the value conclusions are reasonable and based on facts presented in the appraisal. The reviewer has the authority to approve, adjust, request additional data or corrections, or not to recommend and request another appraisal. The reviewer has the authority to approve appraisals not in excess of \$750,000.00. All appraisals showing compensation in excess of \$750,000.00 are referred to the Department's State Appraiser for approval, with the written recommendation of the reviewer. The Design-Build Team's reviewer must be on the Department's approved state certified reviewer appraiser list. The Design-Build Team may request its state certified review appraiser to be added to the approved state certified reviewer appraiser list, subject to approval by the Department's State Appraiser. Any appraisal over \$1,000,000.00 must have a minimum of two appraisals.
- The Design-Build Team shall provide a right of way certification prior to entering any property.

EROSION AND SEDIMENTATION CONTROL SCOPE OF WORK (10-20-10)

The NCDOT REU shall review and accept all Erosion and Sedimentation Control Plans. Clearing & Grubbing and Final Grade Release for Construction (RFC) Erosion Control Plans shall be submitted to all NCDOT Personnel listed in the Design-Build Submittal Guidelines before **any** land disturbing activities, including clearing and grubbing, can commence. If the Design-Build Team chooses to perform the work in discrete sections, then a complete set of Clearing & Grubbing and Final Grade RFC Erosion Control Plans shall be submitted, accepted, and distributed as noted above prior to land disturbing activities, including clearing and grubbing, commencing in that section. No land disturbing activities, including clearing and grubbing, shall occur in any location that does not have accepted Clearing & Grubbing and Final Grade RFC Erosion Control Plans. Refer to the most recent version of the *NCDENR - Erosion and Sediment Control Planning and Design Manual* for erosion control design guidelines not addressed in this Scope of Work.

Erosion and Sedimentation Control Plans shall at a minimum address the following:

I. Complete Set of Plans**A. Clearing and Grubbing Phase**

1. Use correct NCDOT symbology.
2. Protect existing drainage structure inlets with Rock Inlet Sediment Trap Type 'A' (RIST-A), Rock Inlet Sediment Trap Type 'C' (RIST-C), Rock Pipe Inlet Sediment Trap Type 'A' (PIST-A), etc.
3. Utilize adequate perimeter controls (temporary silt ditches (TSD), temporary silt fence (TSF), etc.).
4. Utilize skimmer basins and rock measures with sediment control stone (Temporary Rock Sediment Dam Type 'B' (TRSD-B), Temporary Rock Silt Check Type 'A' (TRSC-A), etc.) at drainage outlets.
5. Take into account existing topography and show contour lines.
6. Utilize Temporary Rock Silt Checks Type 'B' (TRSC-B) to reduce velocity in existing ditches with spacing of 250 feet divided by percentage of ditch grade. Also utilize TRSC-Bs in proposed TSDs and temporary diversions (TD).
7. Protect existing streams; do not place erosion control devices in live streams.
8. Provide adequate silt storage for 3600 cubic feet per disturbed acre and sediment basins shall be sized with surface area equal to 435 square feet per cubic foot per second (cfs) of the peak inflow rate, Q10, using 10-year peak rainfall data (*NCDENR - Erosion and Sediment Control Planning and Design Manual* or NOAA's National Weather Service website http://hdsc.nws.noaa.gov/hdsc/pfds/orb/nc_pfds.html for partial duration (ARI) time series type). A Sediment Basin Designer Spreadsheet will be provided by the NCDOT Roadside Environmental Unit (REU) upon request.
9. Design Riser Basins to the following standards:
 - a. Surface Area shall be determined by Equation $A(\text{sq. feet}) = Q_{10}(\text{cfs}) * 435$.
 - b. Volume requirement shall be 1800 cubic feet per disturbed acre draining to the riser basin.

- c. Riser Pipe shall have a cross-sectional area 1.5 times that of the barrel pipe.
 - d. The riser pipe shall be non-perforated with a skimmer attached to the bottom of the pipe, one-foot from the bottom of the basin.
 - e. See *NCDENR- Erosion and Sediment Control Planning and Design Manual* for additional design criteria.
10. Skimmer Basins shall provide adequate silt storage for 1800 cubic feet per disturbed acre with surface area equal to 325 square feet per cubic foot per second (cfs) of the peak inflow rate, Q10, using the 10-year peak rainfall data (*NCDENR - Erosion and Sediment Control Planning and Design Manual* or NOAA's National Weather Service website http://hdsc.nws.noaa.gov/hdsc/pfds/orb/nc_pfds.html for partial duration (ARI) time series type). A Skimmer Basin Designer Spreadsheet will be provided by the NCDOT Roadside Environmental Unit (REU) upon request.
 11. The minimum and maximum length to width ratio of all Sediment Basins shall be 2:1 and 6:1, respectively.
 12. Coir Fiber Baffles shall be installed in all silt basins and sediment dams at drainage outlets. For silt basins with a 20-foot or longer length, three Coir Fiber Baffles shall be installed with a spacing of 1/4 the basin length. For silt basins with a length less than 20 feet, a minimum of two Coir Fiber Baffles shall be installed, with a spacing of 1/3 the basin length. The Design-Build Team will not be required to show the individual baffles on the Erosion Control Plans, but shall be required to incorporate the Coir Fiber Baffle Detail on the Erosion Control Plans.
 13. Include any culvert and / or pipe construction sequence plan sheets in the Clearing & Grubbing Erosion Control Plans; all pipes 48 inches or larger, or any combination of pipes that total 48 inches or more require a construction sequence. Prior to installation of pipes smaller than 48 inches in jurisdictional areas, the Design-Build Team shall submit a phasing plan for managing the watercourse to the Resident Engineer for review and acceptance. The phasing plan shall be in accordance with the Best Management Practices for Construction and Maintenance Activities.
 14. Incorporate temporary sediment basins into permanent stormwater devices.
 15. Utilize Wattles with Polyacrylamide (PAM) and / or TRSC-A's with Matting and PAM in temporary and permanent, existing and proposed ditches at a spacing of 50 feet in areas where sediment basins are not feasible at drainage outlets, and in areas where sediment basins at drainage outlets with sediment traps (i.e. PIST-A, RIST-A, etc.) cannot be properly sized to surface area and / or sediment storage requirements due to safety concerns, right of way restrictions, utility conflicts or other construction limitations approved by the Roadside Environmental Unit.

B. Final Grade Phase

1. Use correct NCDOT symbology.
2. Protect existing and proposed drainage structure inlets with RIST-A, RIST-C, PIST-A, etc.
3. Utilize adequate perimeter controls (TSD, TSF, etc.).
4. Utilize TRSC-B's to reduce velocity in existing and proposed ditches with spacing of 250 feet divided by percentage of ditch grade. Also, utilize TRSC-Bs in proposed TSDs and TDs.

5. Utilize temporary slope drains and earth berms at top of fill slopes 8 feet or higher and a fill slope grade of 3:1 or steeper, or where there are superelevations above 0.04 and fills are greater than 5 feet. Maximum slope drain spacing shall be 200 feet.
6. Utilize rock energy dissipater and / or silt basin at outlet of slope drain.
7. Devices at all drainage turnouts shall utilize skimmer or sediment control stone (TRSD-B, TRSC-A, etc.) and a spillway with an adequately designed base length to distribute outflow.
8. Provide adequate silt storage for 3600 cubic feet per disturbed acre and sediment basins shall be sized with surface area equal to 435 square feet per cubic foot per second (cfs) of the peak inflow rate, Q10, using 10-year peak rainfall data (*NCDENR - Erosion and Sediment Control Planning and Design Manual* or NOAA's National Weather Service website http://hdsc.nws.noaa.gov/hdsc/pfds/orb/nc_pfds.html for partial duration (ARI) time series type). A Sediment Basin Designer Spreadsheet will be provided by NCDOT REU upon request.
9. Provide matting for erosion control in all ditch lines including but not limited to temporary ditch lines (TDs) utilized to divert offsite runoff around construction areas, where the velocity is greater than 2.0 ft/s, and the shear stress is 1.55 psf or less. For ditch lines with a shear stress above 1.55 psf, Permanent Soil Reinforcement Mat or Rip Rap shall be utilized.
10. Provide matting for erosion control on all fill slopes 2:1 or steeper.
11. Design Riser Basins to the following standards:
 - a. Surface Area shall be determined by Equation $A(\text{sq. feet}) = Q10(\text{cfs}) * 435$.
 - b. Volume requirement shall be 1800 cubic feet per disturbed acre draining to the riser basin.
 - c. Riser Pipe shall have a cross-sectional area 1.5 times that of the barrel pipe.
 - d. The riser pipe shall be non-perforated with a skimmer attached to the bottom of the pipe, one-foot from the bottom of the basin.
 - e. See *NCDENR- Erosion and Sediment Control Planning and Design Manual* for additional design criteria.
12. Skimmer Basins shall provide adequate silt storage for 1800 cubic feet per disturbed acre with surface area equal to 325 square feet per cubic foot per second (cfs) of the peak inflow rate, Q10, using the 10-year peak rainfall data (*NCDENR - Erosion and Sediment Control Planning and Design Manual* or NOAA's National Weather Service website http://hdsc.nws.noaa.gov/hdsc/pfds/orb/nc_pfds.html for partial duration (ARI) time series type). A Sediment Basin Designer Spreadsheet will be provided by the NCDOT Roadside Environmental Unit (REU) upon request.
13. The minimum and maximum length to width ratio of all Sediment Basins shall be 2:1 and 6:1, respectively.
14. Coir Fiber Baffles shall be installed in all silt basins and sediment dams at drainage outlets. For silt basins with a 20-foot or longer length, three Coir Fiber Baffles shall be installed with a spacing of 1/4 the basin length. For silt basins with a length less than 20 feet, a minimum of two Coir Fiber Baffles shall be installed, with a spacing of 1/3 the basin length. The Design-Build Team will not be required to show the individual baffles on the Erosion Control Plans, but shall be required to incorporate the Coir Fiber Baffle Detail on the Erosion Control Plans.
15. Incorporate temporary sediment basins into permanent stormwater devices.

16. Utilize Wattles with Polyacrylamide (PAM) and / or TRSC-A's with Matting and PAM in temporary and permanent, existing and proposed ditches at a spacing of 50 feet in areas where sediment basins are not feasible at drainage outlets, and in areas where sediment basins at drainage outlets with sediment traps (i.e. PIST-A, RIST-A, etc.) cannot be properly sized to surface area and / or sediment storage requirements due to safety concerns, right of way restrictions, utility conflicts or other construction limitations approved by the Roadside Environmental Unit.

C. Intermediate Phase

Intermediate Erosion Control Plans shall only be required if design modifications and / or site conditions require additional erosion control design or design revisions to the RFC Clearing and Grubbing and / or RFC Final Grade Erosion Control Plans. Intermediate Plans shall be submitted for review and shall be accepted prior to construction of any aspect impacted by the revised erosion control design. For any intermediate phase, comply with Section B, "Final Grade Phase" above.

II. Detail Sheets and Notes

- A. Provide project specific special notes and details such as temporary rock silt check type B, coir fiber baffle, skimmer basin, wattle with Polyacrylamide (PAM), etc.
- B. Provide matting summary sheet(s): matting for erosion control and permanent soil reinforcement mat
- C. Provide reforestation sheet(s): regular, wetland, streambank and / or buffer showing appropriate species

III. Title Sheet

- A. Show correct notes: HQW, ESA, clearing and grubbing, etc.
- B. Show correct standards for project
- C. List of standard NCDOT symbology
- D. Show name and certification number of Level IIIA certified individual responsible for designing and/or reviewing Erosion and Sedimentation Control Plans

IV. Special Provisions

- A. Erosion Control Special Provisions are available at the following website:
http://www.ncdot.org/doh/operations/dp_chief_eng/roadside/soil_water/special_provisions/
- B. References in Erosion Control Special Provisions from the aforementioned website to Method of Measurement, Basis of Payment, or any other statement regarding direct payment for Erosion & Sediment Control measures shall be disregarded.
- C. Erosion Control / Stormwater Certification found elsewhere in this RFP.

V. Miscellaneous

- A. Plan submittals shall include all pertinent design information required for review, such as design calculations, drainage areas, etc.
- B. The NCDOT REU will provide a sample set of Erosion and Sedimentation Control Plans (including any special details or special provisions used by the NCDOT REU) and MicroStation Erosion Control Workspace to the Design-Build Team for reference upon request.
- C. Plans shall address any environmental issues raised during the permitting process.
- D. Sufficient time shall be allowed for the Design-Build Team to make any changes to the Erosion and Sedimentation Control Plans deemed necessary by the NCDOT REU.
- E. Temporary access and haul roads, other than public roads, constructed or used in connection with the project shall be considered a part of the project and addressed in the Erosion and Sedimentation Control Plans.
- F. Borrow or waste areas that are part of the project shall require a separate Reclamation Plan, unless the borrow or waste activity is regulated under the *Mining Act of 1971*, or is a landfill regulated by the Division of Solid Waste Management (NCDENR). The Design-Build Team shall submit the permit number for waste / borrow sites covered by the Mining Act or regulated by DSWM (DENR) concurrently to the Transportation Program Management Director and the Resident Engineer. For Reclamation Procedures, see:

http://www.ncdot.org/doh/operations/dp_chief_eng/roadside/fieldops/downloads/Files/ContractedReclamationProcedures.pdf

- G. Whenever the Engineer determines that significant erosion and sedimentation continues despite the installation of approved protective practices, the Design-Build Team shall be required to and shall take additional protective action.
- H. An accepted Erosion and Sedimentation Control Plan does not exempt the Design-Build Team from making every effort to contain sediment onsite.
- I. Any Erosion Control Design revisions made during the construction of the project shall be submitted to NCDOT REU by the 15th of the month via the Transportation Program Management Director. At anytime requested by the Engineer or the Roadside Environmental Unit, the Design-Build Team shall provide an updated version of the Erosion and Sedimentation Control Plans for distribution to all parties involved in the construction process.
- J. The Design-Build Team shall comply with the *North Carolina Administrative Code Title 15 A Department of Environment and Natural Resources Chapter 4, Sediment Control*.
- K. A pre-design meeting shall take place between the NCDOT REU Soil & Water Engineering Section, the Design Build Team, and any other pertinent NCDOT personnel before any Erosion and Sedimentation Control Designs are submitted to NCDOT REU. Erosion and Sedimentation Control Plan submittals shall only be reviewed and accepted by NCDOT REU after the Erosion Control Pre-Design Meeting. The Design Build Team shall be required to submit a tentative Erosion and Sedimentation Control Plan submittal schedule at the pre-design meeting.
- L. At minimum, the Design Build Team shall bring one erosion control plan sheet with a Clearing & Grubbing erosion control design to the Erosion and Sedimentation Control Plan pre-design meeting.

- M. All RFC Erosion and Sedimentation Control Plans, including any red line revisions, shall be kept on site at all times throughout the duration of the project.
- N. Erosion Control / Stormwater Certification shall be required according to the Project Special Provision found elsewhere in this RFP.
- O. Prior to installation of any erosion control devices, the Design-Build Team shall verify boundaries of jurisdictional areas in the field and delineated with Safety Fence or flagging. For guidance on Safety Fence and flagging in jurisdictional areas, reference:

http://www.ncdot.org/doh/operations/dp_chief_eng/roadside/fieldops/downloads/

- P. Once RFC Erosion and Sedimentation Control Plans are issued, any major design change or addition, any change that involves calculations, and / or any addition, deletion, or relocation of a sediment basin shall be submitted to the NCDOT REU for review and acceptance. Minor changes such as moving silt fence, adding or moving temporary ditches (unless adding new flow to a sediment basin), and adding or moving slope drains shall be reviewed by the Engineer in the field.

EROSION CONTROL LIQUIDATED DAMAGES:

The Design-Build Team shall observe and comply with Federal and State Laws, Local Laws, Ordinances, and Regulations; as well as Orders and Decrees of Bodies having any jurisdiction or authority in accordance with Section 107 of the 2006 *Standard Specifications for Roads and Structures*.

The Design-Build Team shall take all reasonable precautions to comply with all regulations of all authorities having jurisdiction over public and private land governing the protection of erosion and sedimentation. Any fines, remediation required or charges levied against the Department for failing to comply with all rules and regulations concerning erosion and sediment control, due to the Design-Build Team's negligence, carelessness, or failure to implement the Erosion and Sedimentation Control Plans and Specifications; or failure to maintain an approved Storm Water Pollution Prevention Plan (SWPPP), regardless of absence of neglect, shall be deducted from monies due the Design-Build Team. In addition to said fines, remediation required, or charges levied, any associated engineering costs or actions taken by the Department in order for the Department to comply with rules and regulations, as a result of the Design-Build Team's negligence, carelessness, or failure to implement the Erosion and Sedimentation Control Plans and Specifications; and / or the SWPPP, regardless of absence of neglect, shall be deducted from the monies due to the Design-Build Team.

LIGHTING SCOPE OF WORK (9-1-10)

Provide and install roadway lighting equipment and materials, in accordance with Division 1400 of the *2006 NCDOT Standard Specifications for Roads and Structures*, and the *Roadway Standard Drawings*, except as amended below. NCDOT will provide the lighting design.

Allow 10 days to update and finalize lighting design after Release for Construction (RFC) Roadway plans are complete and accepted by the Transportation Program Management Director. Provide electronic CADD files in MicroStation format, using Geopak Software (current version used by the Department) showing design changes.

Allow 10 days for Department review of each submittal for all materials including poles and foundation designs. An additional 10 days shall be required for pole submittals from vendors that do not commonly do business with the Department.

Maintain the lighting system until the project is accepted.

Reference the Traffic Management Scope of Work found elsewhere in this RFP for time restrictions and lane closure requirements.

MATERIALS**Light Control System**

Amend Section 1408-2 of the *2006 Standard Specifications for Roads and Structures* as follows:

The completed light control system shall be marked "Suitable for Use as Service Equipment", in a prominent location in the enclosure, in accordance with NEC article 409.110.

Provide a polymer concrete (PC) junction box measuring 36"L x 24"W x 18"H (PC36) and meeting the requirements of Section 1411 of the Standard Specifications.

CONSTRUCTION**Wiring Methods**

Amend Section 1400-4(F) of the *2006 Standard Specifications for Roads and Structures* to include the following:

Pull conductors by hand, or use motorized cable-pulling equipment designed for pulling multiple cables into conduit. Use sheaves or rollers, as required to prevent damage to conductor insulation. Do not use an automobile to generate cable pulling forces. Use equipment similar to the Greenlee model UT2 cable pulling system, or Engineer approved equal.

Inspections

Amend Section 1400-5 of the *2006 Standard Specifications for Roads and Structures* to include the following:

Provide the personnel and equipment necessary for removing and replacing fuseholders and/or operating circuit breakers, to facilitate the insulation resistance test described elsewhere in the Special Provisions.

To minimize the potential for delays preparing the final inspection punch list, the Design-Build Team shall coordinate inspection of the items defined in the NCDOT LIGHTING SYSTEM INSPECTION CHECKLIST with the project inspector as work progresses and at the end of the project. Upon request, a copy of the NCDOT LIGHTING SYSTEM INSPECTION CHECKLIST will be provided.

Performance Tests

Amend Section 1400-6 of the *2006 Standard Specifications for Roads and Structures* to include the following:

Provide a calibrated MegOhmMeter, with certification that calibration was done recently (within one year of use). Provide a meter manufactured by Fluke, Amprobe, Biddle, or Engineer approved equal. Present the meter for inspection at the pre-lighting-work meeting described elsewhere in this Scope of Work.

Removing water from the conduit of a faulty circuit is not considered a repair. Water in the conduit allows current to flow between skinned places in the conductors insulation. If a circuit fails the insulation resistance test, and removing water allows the circuit to pass, replace the conductors and re-test the new circuit.

Construction Phasing

Amend Section 1400-11 of the *2006 Standard Specifications for Roads and Structures* to include the following:

Schedule a pre-lighting-work meeting before beginning work on the lighting system. Include staff members from the prime contractor, electrical sub-contractor, Resident Engineer's office, and the Lighting/ Electrical squad in the Roadway Design Unit in Raleigh.

High Mount Standard

Same as Section 1401-3 of the *2006 Standard Specifications for Roads and Structures* except as amended below:

Tighten anchor rod nuts in accordance with the Anchor Rod Nut Tightening Requirements section of the Project Special Provision for Overhead Sign Supports.

Light Control System

Amend Section 1408-3 of the *2006 Standard Specifications for Roads and Structures* to add the following:

Install PC36 junction box within 2' of edge of pad in front of Control System. Stub all feeder circuit conduits and spare conduits from Control System in this junction box. See plans for conduit sizes. Place pull cord in any unused conduits and cap unused conduit in junction box.

FINAL INSPECTION

Contact Lighting / Electrical engineers from NCDOT to inspect the completed lighting system and perform insulation resistance testing for all conductors prior to contract acceptance.

ELECTRICAL SERVICE

Coordinate with the local utility company, make application and pay all deposit fees to provide necessary electrical service. Refer to Utilities Coordination Scope of Work for additional coordination / approval requirements, payments and other costs.

MAINTENANCE

Assume responsibility for routine maintenance of the lighting system(s) for the duration of the contract in accordance with Section 1400 of the *2006 NCDOT Standard Specifications for Roads and Structures*, except as amended below.

NCDOT will pay the monthly power bills. NCDOT will assume maintenance responsibility for the completed lighting systems after the project is accepted, and there is no chance of construction-related damage.

ENVIRONMENTAL SCOPE OF WORK (9-1-10)**USACE 404 Permit and DWQ 401 Certification**

NCDOT has been issued the Section 404 and 401 permits for this project. The permit expiration date has been extended to December 31, 2013. The Department has re-verified threatened and endangered species surveys on November 4, 2009.

Unless noted otherwise in this RFP, all work by the Design-Build Team must be accomplished in compliance with the permits and certifications issued by the agencies and as may be amended under permit modification(s). The Design-Build Team shall provide each of its contractors and / or agents associated with the construction or maintenance of this project with a copy of the permits. Unless otherwise noted in this RFP, the Design-Build Team shall also adhere to the commitments made as part of the Environmental Assessment, Finding of No Significant Impact, and all consultations.

The Design-Build Team shall identify in the Technical Proposal any changes to the design and / or construction methods that may require permit modifications. All required coordination with the environmental agencies, approvals from the environmental agencies, public involvement, utility relocation / coordination, and / or permit modifications resulting from a variation in the Department's proposed design and / or construction methods shall be the sole responsibility of the Design-Build Team.

The Department will not honor any requests for additional contract time or compensation for any efforts required in order to obtain any permit modification, including but not limited to public involvement, additional design effort, additional construction effort and / or additional environmental agency coordination and approvals.

Unanticipated Discovery

If the Design-Build Team discovers any previously unknown historic or archeological remains while accomplishing the authorized work, he shall immediately notify NCDOT Staff Archaeologist and/or NCDOT Project Development Engineer, as listed below, who will initiate the required State/Federal coordination. All questions regarding these sites should be addressed to Mr. Matthew Wilkerson, NCDOT Archaeology (919) 431-1609, or Mr. Linwood Stone, NCDOT Project Development (919) 733-7844, ext. 206.

PUBLIC INFORMATION SCOPE OF WORK (09-13-10)

The Design-Build Team will take the lead role on this project and be responsible for the public information efforts through the NCDOT's IMPACT Public Information Program. The Design-Build Team's responsibilities will include:

- Organizing public meetings, with assistance from the Department to secure a facility
- Providing media announcements
- Developing and producing informational print materials
- Providing details surrounding the project impacts to the public
- Providing advance notice to the Department of upcoming project impacts
- Attending and/or speaking at public meetings
- Facilitate Operations Meetings that will be held once a month during construction
- Attend Incident Management meetings that will be held once a quarter during construction

NCDOT, through the IMPACT Public Information Program, will be responsible for reviewing and approving all of the public information materials created by the Design-Build Team for distribution for this project. The NCDOT will be responsible for mailing public informational material to the identified target audiences, including all necessary postage.

The Design-Build Team shall coordinate with the Department to promote public awareness for this project. The Design Build Team, with assistance from the Department, shall develop a Public Information Plan that identifies the target audiences, details project impacts and outlines proposed efforts to notify the public about the impacts. The following groups are identified as typical target audiences to receive informational materials:

- Governmental agencies
- Municipalities directly affected by construction
- Transportation services
- Emergency services
- Neighborhood groups and private homes
- Industry and businesses
- Chamber of Commerce
- Individual schools effected by the project
- County/City school systems
- Any other organization as deemed necessary by the Department.

The Design-Build Team shall hold an initial project coordination meeting with NCDOT one month prior to start of construction to discuss project impacts to the public and the Public Information Plan.

The Design-Build Team shall inform the Department at least 3 weeks in advance of any construction activity that will have significant impact on the public, including but not limited to the start of construction, major traffic shifts, road closures, ramp closures, detours, night work and project completion. In the event that the Design-Build Team informs the Department of a

construction activity that significantly impacts the public less than three weeks in advance, the Design-Build Team shall hand deliver informational material to the target audiences.

The amount of public information required for this project is directly based on the Design-Build Team's Traffic Control Plans and construction details. The minimum public information requirements solely associated with the Traffic Control Plans shall include, but not be limited to, the following:

- Public Meetings – If Beginning of Construction meeting for area businesses and residents is held, attending and/or speaking at this event. Conduct meetings when necessary to inform businesses, residents and motorists of major traffic shifts or construction events.
- Distribution of Informational Materials - For beginning of construction and for all road/ramp closures with detour routes, the Design-Build Team shall be responsible for developing and producing informational material for the impacted target audiences. If the Design-Build Team informs the Department of the aforementioned activities less than three weeks in advance, the Design-Build Team shall hand deliver the informational material to the impacted target audiences.

The Design-Build Team shall include in their Lump Sum Bid price for the project, all costs associated with their involvement in Public Information scope of work.

A website site shall be required for this project. The website shall be housed on a non-NCDOT server. The Design-Build Team shall submit the initial general content of the website to the Department for review and approval. The Department reserves the right to periodically review the website for inappropriate content and direct revisions to the content. All costs associated with setting up and maintaining this website shall be include in the lump sum bid for this project.

***** PROJECT SPECIAL PROVISION *****

(10-18-95)

Z-1

PERMITS

The Design-Build Team's attention is directed to the following permits that have been issued to the Department of Transportation by the authority granting the permit.

PERMIT**AUTHORITY GRANTING THE PERMIT**

Water Quality 401 Certification	Division of Water Quality, DENR State of North Carolina
Section 404 Permit	United States Army Corps of Engineers

The Design-Build Team shall comply with all applicable permit conditions during construction of this project. Agents of the permitting authority will periodically inspect the project for adherence to the permits.

The Design-Build Team's attention is also directed to Articles 107-10 and 107-14 of the *Standard Specifications* and the following:

Should the Design-Build Team propose to utilize construction methods (such as temporary structures or fill in waters and/or wetlands for haul roads, work platforms, cofferdams, etc.) not specifically identified in the permit (individual, general, or nationwide) authorizing the project it shall be the Design-Build Team's responsibility to coordinate with the Engineer to determine what, if any, additional permit action is required. The Design-Build Team shall also be responsible for initiating the request for the authorization of such construction method by the permitting agency. The request shall be submitted through the Engineer. The Design-Build Team shall not utilize the construction method until it is approved by the permitting agency. The request normally takes approximately 60 days to process; however, no extensions of time or additional compensation will be granted for delays resulting from the Design-Build Team's request for approval of construction methods not specifically identified in the permit.

Where construction moratoriums are contained in a permit condition which restricts the Design-Build Team's activities to certain times of the year, those moratoriums will apply only to the portions of the work taking place in the waters or wetlands provided that activities outside those areas is done in such a manner as to not affect the waters or wetlands.



REPLY TO
ATTENTION OF:

DEPARTMENT OF THE ARMY
WILMINGTON DISTRICT, CORPS OF ENGINEERS
69 DARLINGTON AVENUE
WILMINGTON, NORTH CAROLINA 28403-1343

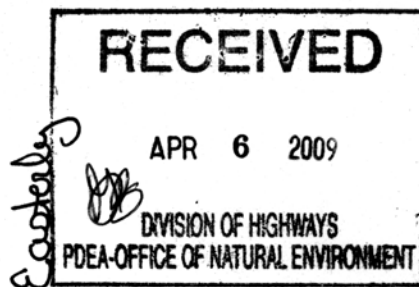

April 1, 2009

Regulatory Division

Action ID. 199821203; TIP No. I-23⁹4A

Dr. Gregory J. Thorpe, Ph.D.
Environmental Management Director, PDEA
N.C. Department of Transportation
1598 Mail Service Center
Raleigh, North Carolina 27699-1598

Dear Dr. Thorpe:

Reference is made to your Department of the Army (DA) permit issued on December 16, 2004, authorizing the discharge of fill material into waters of the United States (jurisdictional waters) for construction of Section A of the Interstate 85 (I-85) Improvements (T.I.P. No. I-2304A), from north of SR 2120 (Exit 81), northeast of Spence, in Rowan County, to north of I-85 Business (Exit 87), southwest of Lexington, in Davidson County, North Carolina. The project is adjacent to jurisdictional waters of the Yadkin River, Potts Creek, and unnamed tributaries of the Yadkin River.

Reference is also made to your written request of February 20, 2009, to extend your DA permit. As stated in your request the project was scheduled to start construction in 2004; however, funding for the project was cut and construction of the project was never started. At this time, new funding for the project is anticipated and the NCDOT plans to proceed with construction. The current DA permit for the project has an expiration date of December 31, 2009. It is expected that the project including the replacement and demolition of several bridges will take four years to complete. Therefore, you have requested a four year extension of your current DA permit. In accordance with your request, your permit is hereby extended until December 31, 2013. All other conditions of the original permit remain in full force and effect.

If the permitted work is not completed on or before the date herein specified, the authorization, if not previously revoked or specifically further extended, will cease and become null and void. If additional time is required to complete the project, you should contact this office with a request for an additional time extension.

Should you have questions, please contact Mr. John Thomas, Raleigh Regulatory Field Office, telephone (919) 554-4884 extension 25.

Sincerely,

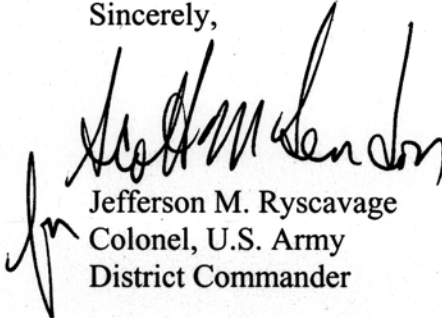

Jefferson M. Ryscavage
Colonel, U.S. Army
District Commander

Copies furnished:

Mr. Brian Wrenn
Division of Water Quality
North Carolina Department of Environment
and Natural Resources
1650 Mail Service Center
Raleigh, North Carolina 27699-1650

Mr. Travis Wilson
Eastern Region Highway Project Coordinator
Habitat Conservation Program
1142 I-85 Service Road
Creedmoor, North Carolina 27522

Mr. Pete Benjamin
U.S. Fish and Wildlife Service
Fish and Wildlife Enhancement
Post Office Box 33726
Raleigh, North Carolina 27636-3726

Mr. Chris Militscher
C/O FHWA
U.S. Environmental Protection Agency
Raleigh Office
310 New Bern Avenue, Room 206
Raleigh, North Carolina 27601

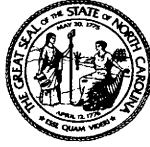

STATE OF NORTH CAROLINA
DEPARTMENT OF TRANSPORTATION

MICHAEL F. EASLEY
GOVERNOR

LYNDO TIPPETT
SECRETARY

December 23, 2004

MEMORANDUM TO: Mr. S. P. Ivey, P.E.
Division 9 Engineer

FROM: Philip S. Harris, III, P.E., *Manager* *for*
Office of Natural Environment
Project Development and
Environmental Analysis Branch

SUBJECT: Rowan-Davidson Counties, I-85 North of SR 2120 (Exit 81) in
Rowan County to US 29-52-70/I-85 Business (Exit 87) in
Davidson County; Federal Project No. NHF-85-3 (164) 80; State
Project No. 8.1631403; TIP Number I-2304A

Attached is the Individual Permit and a modification to the Division of Water Quality 401 Water Quality Certification for the above referenced project. All environmental permits have been received for the construction of this project.

PSH/gyb

Attachment

cc: Mr. Art McMillan, P.E.
Mr. Jay Bennett, P.E.
Mr. David Chang, P.E.
Mr. Randy Garris, P.E.
Mr. Greg Perfetti, P.E.
Mr. Mark Staley
Mr. John F. Sullivan, III, FHWA
Mr. Omar Sultan
Ms. Diane Hampton, P.E., Division 9 DEO

PROJECT COMMITMENTS

I-85

**North of SR 2120 (Exit 81) in Rowan County to
US 29-52-70/I-85 Business (Exit 87) in Davidson County
Rowan-Davidson Counties
Federal Aid Project No. NHF-85-3(164)80
State Project No. 8.1631403
T.I.P. Project No. I-2304A**

Commitments Developed Through Project Development and Design

Project Development and Environmental Analysis Branch (PDEA)

Because the subject project lies within a Federal Energy Regulatory Commission (FERC)-licensed hydroplant project boundary (the Yadkin Project), approval for land transfer must be obtained by NCDOT in the form of a FERC license revision. Coordination with the proper FERC officials shall take place, and the process to obtain a FERC permit will be followed.

Geotechnical Unit

It is anticipated that the proposed widening of I-85 and interchange reconstruction along I-85 will encroach on one property identified as an underground storage tank (UST) site. The project has been designed to minimize impacts to this UST site to prevent the possibility of long-term, costly remediation. This impacted site will be further evaluated before the project's construction.

Structure Design Unit

The Structure Design Unit will coordinate with the Norfolk Southern Corporation, Duke Power, and the North Carolina Railroad concerning the highway improvements affecting the freight railroads. The Structure Design Unit will also coordinate with NCDOT Rail Division, Norfolk Southern Corporation, and North Carolina Railroad for the future high-speed passenger rail corridor between Charlotte and Raleigh.

PDEA

Due to its historical significance, Bridge # 46, which carries US 29-70 over the Yadkin River in the southbound direction, will remain in place but will be closed to vehicular traffic. The bridge will remain in place to serve pedestrian and bicycle traffic. Ownership, liability, and maintenance responsibilities are currently being discussed by the Rowan and Davidson County Commissioners, the Transportation Museum, and the State Historic Preservation Office (SHPO). It is anticipated that these issues will be resolved before the project construction.

The issues related to ownership, liability, and maintenance responsibilities have not been resolved by the above-mentioned parties. These issues continue to be discussed by the local officials.

Right of Way Branch

It is anticipated that thirteen Geodetic Survey markers will be impacted by this project. The North Carolina Geodetic Survey will be contacted prior to construction regarding the relocation of survey markers along the project.

PDEA / Structure Design Unit

Removal of Bridge #137, which spans the Yadkin River, results in potentially 1,254 cubic yards of temporary fill. NCDOT will implement Best Management Practices for Bridge Demolition and Removal.

Upon further analysis of the amount of temporary fill resulting from bridge demolition, it was determined that only the amount of fill from the substructure would result in temporary fill. The likely potential amount of fill resulting from bridge demolition will be approximately 430 cubic yards. NCDOT will implement Best Management Practices for Bridge Demolition and Removal.

PDEA

The project may have an impact on a low income community in the Williams Trailer Park area located along I-85 south of SR 2124 (Hackett Road). During the project development process, no concerns have been raised by the public or local government officials concerning environmental justice issues. NCDOT will aggressively seek participation of this low-income community in the public involvement process.

NCDOT held two meetings with the citizens of the Williams Trailer Park. The first meeting was held in the Spencer Town Hall on 6/19/2001, and the second meeting was held in the North Carolina Transportation Museum on 6/24/2002. During these meetings, the design was presented to the trailer park residents, and their input and concerns related to the project were obtained. In addition to these meetings, a more detailed analysis was performed to determine the impacts to this area, and the determination has been made that this project does not create impacts related to Environmental Justice for the Williams Trailer Park.

PDEA / Design Services Unit

Based on preliminary studies, five areas were identified as possible noise barrier locations. These noise barriers were determined to be unreasonable, due to the cost of the noise reduction benefits versus the cost of the abatement measures. However, the project will be re-evaluated for noise abatement measures once more detailed designs are complete.

The project was re-evaluated for noise abatement measures. Noise mitigation in the form of a wall was analyzed for several areas along the project. For the I-2304AA section, one location, known as Barrier Location 2, it was determined that a barrier in this location is considered reasonable and feasible by NCDOT guidelines. Hence, a noise wall is recommended in this area. Further coordination with the affected residents and/or businesses will take place concerning this proposed noise wall.

PDEA / Design Services Unit/Construction Unit

A roadside memorial exists within the project limits, however it is not anticipated to be impacted by this project. This memorial, dedicated in 1929 by the North Carolina Historic Commission, which currently owns the property, was investigated for its historical significance. It was determined that this Trading Ford Monument is not eligible for the National Register of Historic Places. Based on this site visit and other information compiled by NCDOT, no additional archaeological work was deemed necessary for this site. The Historic Preservation Office has requested that the bronze plaque be returned to them if the monument has to be removed during construction. Additionally, NCDOT will coordinate with local officials and SHPO to determine if there is a more suitable location for the marker.

Design Services Unit / Structure Design Unit

In accordance with the FERC requirements, a Construction Permit will be issued to NCDOT once all requested information is reviewed and approved by FERC. The construction permit will contain a condition, among many others, that with regard to existing bridges, that NCDOT will be required to remove all concrete down to the existing muck line so that it will not be a hazard or act as a “catch” for floating debris.

PDEA

The biological conclusion for the bald eagle was revised to “Not Likely to Adversely Affect.” This conclusion was approved by the USFWS. Because eagles may potentially nest in this area prior to bridge construction, NCDOT will re-survey for bald eagles prior to the project’s construction.

Commitments Developed Through Permitting

Section 401 Water Quality Certification Conditions

Division 9, Roadside Environmental Unit (REU)

Sediment and erosion control measures shall not be placed in wetlands or waters to the maximum extent practicable. If placement of sediment and erosion control devices in wetlands and waters is unavoidable, they shall be removed and the natural grade restored within 30 days after the project has been released.

Division 9

Stormwater management shall be constructed in accordance with the hydraulic design plans submitted in the February 20, 2004 application.

Hydraulics Unit

The hazardous spill catch basins (I-2304AA Plan Sheet 9) shall be designed and located to afford ready access to maintenance and emergency response personnel and equipment.

- The volume of spill containment storage provided will be approximately 10,000 gallons plus the estimated runoff volume from rainfall intensity equating to a two-year return period event.
- A means will be provided such that the normal free flow of runoff at the basin outlet can be interrupted to cause containment of hazardous runoff. This can be accomplished by providing a mechanical control gate or by constructing a minimum control section in the outlet channel. The mechanical gate alternative will generally be utilized in areas where normal operational activities would allow close scrutiny and control, reducing the potential for problems with vandalism.
- Maintenance plans for constructed basins shall be developed in accordance with Best Management Practices (BMPs) and good engineering practices. Additional guidance for properly maintaining containment basins can be found at 40 CFR Part 112, §112.7, *et al.* (Spill Prevention Control and Countermeasures).
- Inspections of the hazardous spill catch basin and opening/shutting of the gate should be performed annually at a minimum, and within six (6) months after a spill incident to ensure integrity of the catch basin.
- Repairs should occur in a timely manner.
- NCDOT should provide annually, a site location map of all hazardous spill catch basins and similar devices to Federal (USEPA, USCG), DENR, State Emergency Response Coordinator, and all applicable county and urban center response groups.
- Signage indicating the presence of a hazardous spill catch basin shall be provided.

REU, Division 9

The removal of vegetation in riparian areas should be minimized. NCDOT is encouraged to use existing on-site vegetation and materials for stream bank stabilization and to minimize the use of rip rap. Rip rap shall not be placed in the stream bottom. Riparian vegetation, using native trees and shrubs, must be re-established within the construction limits of the project by the end of the growing season following completion of construction to re-establish the riparian zone and to provide long-term erosion control.

Division 9

Culverts that are less than 48-inch in diameter should be buried to a depth equal to or greater than 20% of their size to allow for aquatic life passage. Culverts that are 48-inch

diameter or larger should be buried at least 12 inches below the stream bottom to allow natural stream bottom material to become established in the culvert following installation and to provide aquatic life passage during periods of low flow. If any of the existing pipes are perched, they shall be removed and replaced, and re-installed correctly, unless demonstrated that this is topographically unfeasible.

PDEA

Summary of Compensatory Mitigation: Compensatory mitigation shall be the same as that approved by the US Army Corps of Engineers, as long as the mitigation required equals a ratio of 1:1 restoration or creation of lost wetland acres as described in 15A NCAC 2H.0506 (h)(6), and consists of the following:

I-2304 Section AA

- 0.02 acres of on-site riverine wetland restoration within I-2304 Section AA.
- 2644 linear feet of stream impacts will be mitigated through NCDENR Ecosystem Enhancement Program (EEP).
- 1.08 acres of impacts to non-riverine wetlands will be mitigated through EEP.

I-2304 Section AB

- 1.03 acres of on-site riverine wetland restoration within I-2304 Section AA.
- 1811 linear feet of stream will be mitigated through EEP.
- 0.16 acres of impacts to non-riverine wetlands will be mitigated through EEP.

In accordance with 15A NCAC 2R.0500, this contribution will satisfy NC Division of Water Quality's compensatory mitigation requirements under 15A NCAC 2H.0506(h). Until the EEP receives and clears NCDOT's payments, wetland or stream fill shall not occur. The payments to EEP shall be sent within two (2) months of issuance of the 404 permit.

Division 9, Design Services Unit, Hydraulics Unit

Two copies of the final construction drawings shall be furnished to NCDWQ prior to the pre-construction meeting. Written verification shall be provided that the final construction drawings comply with the permit drawings contained in the Application dated February 20, 2004 and May 11, 2004.

Division 9

The dimension, pattern and profile of the stream above and below the crossing should not be modified by widening the stream channel or reducing the depth of the stream. Disturbed floodplains and streams should be restored to natural geomorphic conditions. All stream relocation and restoration activities shall comply with the final natural channel design plans approved by the NC Division of Water Quality.

Division 9, REU

All channel relocations will be constructed in a dry work area, and stabilized before stream flows are diverted. Channel relocations will be completed and stabilized prior to diverting water into the new channel. Whenever possible, channel relocations shall be allowed to stabilize for an entire growing season. Vegetation used for bank stabilization shall be limited to native woody species, and should include establishment of a 30 foot wide wooded and an adjacent 20 foot wide vegetated buffer on both sides of the relocated channel to the maximum extent practical. A transitional phase incorporating coir fiber and seedling establishment is allowable. Also, rip-rap may be allowed if it is necessary to maintain the physical integrity of the stream, but NCDOT must provide written justification and any calculations used to determine the extent of rip-rap coverage requested.

All temporary fills in wetlands and surface waters shall be removed upon completion of the project. In addition, the post-construction removal of any temporary bridge structures or fill will need to return the project site to its pre-construction contours and elevations. The revegetation of the impacted areas with appropriate native species will be required.

Section 404 Individual Permit Conditions

Compliance With Plans

Division 9, Design Services Unit

All work must be performed in strict compliance with the plans, which are a part of the Section 404 permit. Any modification to the permit plans must be approved by the US Army Corps of Engineers (USACE) prior to implementation.

Construction Plans

NCDOT will ensure that the construction design plans for this project do not deviate from the permit plans. Written verification shall be provided that the final construction drawings comply with the attached permit drawings prior to any active construction in waters of the United States, including wetlands. Any deviation in the construction design plans will be brought to the attention of the Corps of Engineers, Raleigh Regulatory Field Office prior to any active construction in waters or wetlands.

Sedimentation and Erosion Control Measures

Division 9, REU

NCDOT shall remove all sediment and erosion control measures placed in wetlands or waters, and shall restore natural grades in those areas, prior to project completion.

Mitigation

PDEA

NCDOT shall mitigate for 2.29 acres of wetland impacts, and 4,455 linear feet of impact to streams with important aquatic function, for this project, as described below (1.05 acres of riverine bottomland hardwood wetland restoration at the Yadkin River Swamp Hardwoods Restoration Mitigation Site, and 2.48 acres of restoration equivalent non-riverine wetlands, and 8,910 linear feet of restoration equivalent warm water stream channel, through the North Carolina Ecosystem Enhancement Program (EEP), in the Yadkin River basin (Cataloging Unit 03040103).

YADKIN RIVER SWAMP HARDWOODS RESTORATION MITIGATION SITE

PDEA, Division 9, Roadside Environmental Unit

NCDOT shall implement the compensatory wetland mitigation plan entitled "Restoration Plan for Swamp Hardwoods Wetlands At Existing Bridge Causeway of the I-85 Yadkin River In Rowan County", dated July 12, 2004, to provide the restoration described in conditions below. NCDOT shall complete grading for the mitigation within one year of demolition of the existing I-85 Yadkin River bridge, and complete planting of the site within the first planting season (November 15 to March 15) after grading is completed. NCDOT shall contact the Corps of Engineers, Raleigh Regulatory Field Office NCDOT Regulatory Project Manager, a minimum of sixty days before completion of grading at the mitigation site, and inform the Project Manager of the expected completion date of the grading.

NCDOT shall mitigate for 1.05 acres of unavoidable impacts to riverine bottomland hardwood forest wetlands associated with this project with 1.05 acres of riverine bottomland hardwood forest wetland restoration, at the Yadkin River Swamp Hardwoods Restoration Mitigation Site (Yadkin Site).

NCDOT will do a boundary survey of the 1.05 acres of wetland restoration at the Yadkin Site, and submit a copy of the survey to the District Engineer within 90 days after construction of the site is completed.

NCDOT will monitor the site vegetation between June 1 and November 30, inclusively, of each year, and document plant mortality and stress. A minimum of one 0.05-acre sample plots will be established within the 1.05 acre restoration area, and will be placed randomly within a representative position. NCDOT will continue monitoring of the planting area annually until the specified performance criteria is met, as described below.

YADKIN SITE MITIGATION MONITORING

PDEA, Division 9, Roadside Environmental Unit

Performance criteria for tree planting areas will be met if sample plots demonstrate that for each of the first three complete years of monitoring, 320 target-species trees per acre

have survived, such that at the end of three years, 320 three-year old target-species trees per acre have survived on the site, and, in years four and five, 288 and 260 trees per acre, respectively, have survived on the site, such that at the end of year five, 260 five-year old target-species trees per acre have survived on the site.

If for any monitoring year, vegetation survival is not favorable, as determined by the Corps of Engineers, any remedial action required by the Corps of Engineers will be performed, the required restoration areas will be replanted, and the five-year monitoring period will begin again with year one.

GENERAL WETLANDS MITIGATION

PDEA, Division 9

NCDOT and subsequent property owners shall maintain the Yadkin Site in its natural condition, as altered by work in the mitigation plan, in perpetuity. Prohibited activities within the mitigation site specifically include, but are not limited to: the construction or placement of roads, walkways, buildings, signs, or structures of any kind (i.e., billboards, interior fences, etc.); filling, grading, excavation, leveling, or any other earth moving activity or activity that may alter the drainage patterns on the property; the cutting, mowing, destruction, removal, or other damage of any vegetation; disposal or storage of any debris, trash, garbage, or other waste material; except as may be authorized by the mitigation plans, or subsequent modifications that are approved by the Corps of Engineers. In addition, NCDOT shall take no action, whether on or off the mitigation property, which will adversely impact the wetlands on the mitigation property, except as specifically authorized by this permit, or subsequent modifications that are approved by the Corps of Engineers.

NCDOT shall make every effort to convey the Yadkin Site property to a nonprofit conservation organization or a natural resource agency, which is willing to hold the areas in perpetuity for conservation purposes, and which is acceptable to the Corps of Engineers. The annual monitoring reports, as required, will include the status of the conveyance efforts.

NCDOT shall not sell or otherwise convey any interest in the property used to satisfy mitigation requirements for this permit, to any third party, without 10 days prior notification to Wilmington District Corps of Engineers in writing, which writing shall reference this permit Action ID number.

Any sale, lease, or other conveyance of the mitigation site property shall include restrictions on the use of the property as described in conditions above, which conditions shall be enforced by the North Carolina Department of Transportation. Such restrictions shall include language providing for third party enforcement rights in favor of the Corps of Engineers. Such restrictions must be approved prior to conveyance by the Corps of Engineers.

GENERAL MITIGATION

PDEA

NCDOT shall contact the Corps of Engineers, Raleigh Regulatory Field Office NCDOT Regulatory Project Manager, to provide that individual with the opportunity to attend the yearly mitigation monitoring efforts.

NC-EEP STREAM AND WETLAND MITIGATION:

PDEA

Compensatory mitigation for the unavoidable impacts to 1.24 acres of non-riverine wetlands, and 4,455 linear feet of stream associated with the proposed project shall be provided by the Ecosystem Enhancement Program (EEP), as outlined in the letter dated April 30, 2004 from William D. Gilmore, EEP Transition Manager. Pursuant to the EEP Memorandum of Agreement (MOA) between the State of North Carolina and the US Army Corps of Engineers signed on July 22, 2003, the EEP will provide 2.48 acres of restoration equivalent non-riverine wetlands, and 8,910 linear feet of restoration equivalent warm water stream channel in the Yadkin River basin (Cataloging Unit 03040103) by one year of the date of this permit. For wetlands, a minimum of 1:1 (impact to mitigation) must be in the form of wetland restoration. The NCDOT shall, within 30 days of the issue date of this permit, certify that sufficient funds have been provided to EEP to complete the required mitigation, pursuant to Paragraph V. of the MOA.

Navigation

Division 9, Hydraulics Unit, Structure Design Unit

The authorized fill and structures, and associated activities, in the Yadkin River must not interfere with the public's right to free navigation on the river. No attempt will be made by NCDOT to prevent the full and free use by the public of the river at or adjacent to the authorized work for reason other than safety. NCDOT shall not modify the design of the temporary work bridges to provide an unobstructed main channel less than fifty feet wide, with no vertical structural obstructions from the work bridges extending into the opening.

Construction Plans

Division 9, Hydraulics Unit, Design Services Unit

Prior to commencing construction within jurisdictional waters of the United States, NCDOT shall forward the latest version of project construction drawings to the USACE, Raleigh Regulatory Field Office NCDOT Regulatory Project Manager. Half-size drawings are acceptable.

Historic Property

Division 9, PDEA

NCDOT shall leave Bridge No. 46, which currently carries US 29-70 over the Yadkin River in the southbound direction, in place, due to its historical significance. NCDOT shall close the bridge to vehicular traffic, but it will serve pedestrian and bicycle traffic. NCDOT shall work out ownership and maintenance responsibilities with the Rowan and Davidson County Commissioners, the Transportation Museum, and the North Carolina State Historic Preservation Office



Haney
Michael F. Easley, Governor
William G. Ross Jr., Secretary
North Carolina Department of Environment and Natural Resources

AB

Alan W. Klimek, P.E., Director
Division of Water Quality
Coleen H. Sullins, Deputy Director
Division of Water Quality

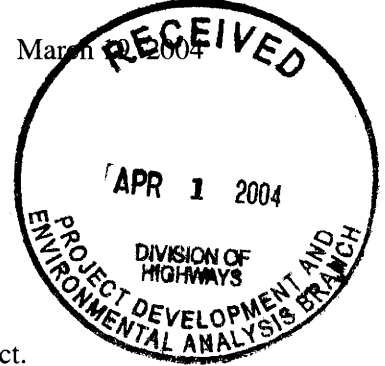

Mr. Gregory J. Thorpe, Ph.D., Environmental Director
NCDOT Planning and Environmental Branch
1548 Mail Service Center
Raleigh, NC, 27699-1548

Dear Dr. Thorpe:

Re: Water Quality Certification Pursuant to §401 of the Federal Clean Water Act.
Improvements to I-85 from north of SR 2120 in Rowan County to north of I-85 Business in Davidson County.
F.A. Project No. NHF-85-3(164)80; State Project No. 8.1631403
✓ TIP No. I-2304AA and I-2304AB
DWQ Project No. 040275

Attached hereto is a copy of Certification No. 3455 issued to The North Carolina Department of Transportation dated March 19, 2004.

If we can be of further assistance, do not hesitate to contact us.

Sincerely,

Alan W. Klimek, P.E.

Attachments

cc: Wilmington District Corps of Engineers
Eric Alsmeyer, USACE Raleigh Field Office
NCDWQ Winston-Salem Regional Office
Christopher Militscher, US Environmental Protection Agency – Region IV
William Gilmore, NC Ecological Enhancement Program
Central Files
File Copy



: Gregory J. Thorpe, Ph.D.
: §401 Water Quality Certification No. 3455
: I-2304 AA and I-2304 BA

NORTH CAROLINA 401 WATER QUALITY CERTIFICATION

THIS CERTIFICATION is issued in conformity with the requirements of Section 401 Public Laws 92-500 and 95-217 of the United States and subject to the North Carolina Division of Water Quality (DWQ) Regulations in 15 NCAC 2H, .0500. This Certification authorizes the NCDOT to incur the following permanent impacts:

I-2304 Section AA

- 0.02 acres of riverine wetlands through excavation and mechanized clearing;
- 1.08 acres of non-riverine wetlands through fill and mechanized clearing;
- 2644 linear feet of jurisdictional stream loss.

I-2304 Section AB

- 1.03 acres of riverine wetlands through fill, excavation, and mechanized clearing.
- 0.16 acres of non-riverine wetlands through fill and mechanized clearing.
- 1811 linear feet of jurisdictional stream loss;
- 0.003 acres of ponds (filling or draining).

The I-2304AA and I-2304AB projects shall be constructed pursuant to the application dated February 20, 2004 to improve I-85 from north of SR 2120 in Rowan County to north of I-85 Business in Davidson County.

The Application provides adequate assurance that the discharge of fill material into the waters of the state with the proposed development will not result in a violation of applicable Water Quality Standards and discharge guidelines. Therefore, the State of North Carolina certifies that this activity will not violate the applicable portions of Sections 301, 302, 303, 306, 307 of PL 92-500 and PL 95-217 if conducted in accordance with the application and conditions hereinafter set forth.

This approval is only valid for the purpose and design that you submitted in your Application. All work authorized by this Certification must be done in strict compliance with the plans attached to the Application. If this project changes, incurring additional impacts to streams, wetlands or buffers, you are required to notify the DWQ *in writing*, and you may be required to submit a new application. Additional compensatory mitigation may be required as described in 15A NCAC 2H .0506 (h) (6) and (7). For this approval to remain valid, you are required to comply with all the conditions listed below. In addition, you should obtain all other federal, state or local permits before proceeding with your project including (but not limited to) Sediment and Erosion Control, Non-discharge and Water Supply watershed regulations.

This Certification shall expire three (3) years from the date of the cover letter from DWQ or on the same day as the expiration date of the corresponding US Army Corps of Engineers Permit, whichever is later.

Condition(s) of Certification:

1. Erosion and sediment control practices must be in full compliance with all specifications governing the proper design, installation and operation and maintenance of such Best Management Practices in order to protect surface waters standards:
 - a. The erosion and sediment control measures for the project must be designed, installed, operated, and maintained in accordance with the most recent version of the *North Carolina Sediment and Erosion Control Planning and Design Manual*.
 - b. The design, installation, operation, and maintenance of the sediment and erosion control measures must be such that they equal, or exceed, the requirements specified in the most recent version of the *North Carolina Sediment and Erosion Control Manual*. The devices shall be maintained on all construction sites, borrow sites, and waste pile (spoil) projects, including contractor-owned or leased borrow pits associated with the project.
 - c. For borrow pit sites, the erosion and sediment control measures must be designed, installed, operated, and maintained in accordance with the most recent version of the *North Carolina Surface Mining Manual*.
 - d. Any reclamation measures and implementation must comply with the reclamation in accordance with the requirements of the Sedimentation Pollution Control Act.
2. No waste, spoil, solids, or fill of any kind shall occur in wetlands, waters, or riparian areas beyond the footprint of the impacts depicted in the Application. All construction activities shall be performed so that no violations of state water quality standards, statutes, or rules occur.
3. Sediment and erosion control measures shall not be placed in wetlands or waters to the maximum extent practicable. If placement of sediment and erosion control devices in wetlands and waters is unavoidable, they shall be removed and the natural grade restored within 30 days after the project has been released.
4. Stormwater management shall be constructed in accordance with the hydraulic design plans submitted in the February 20, 2004 application.
5. The hazardous spill catch basins (I-2304AA Plan Sheet 9) shall be designed and located to afford ready access to maintenance and emergency response personnel and equipment.
 - The volume of spill containment storage provided will be approximately 10,000 gallons plus the estimated runoff volume from rainfall intensity equating to a two-year return period event.
 - A means will be provided such that the normal free flow of runoff at the basin outlet can be interrupted to cause containment of hazardous runoff. This can be accomplished by providing a mechanical control gate or by constructing a minimum control section in the outlet channel. The mechanical gate alternative will generally be utilized in areas where normal operational activities would allow close scrutiny and control, reducing the potential for problems with vandalism.
 - Maintenance plans for constructed basins shall be developed in accordance with Best Management Practices (BMPs) and good engineering practices. Additional guidance for properly maintaining containment basins can be found at 40 CFR Part 112, §112.7, *et al.* (Spill Prevention Control and Countermeasures).
 - Inspections of the hazardous spill catch basin and opening/shutting of the gate should be performed annually at a minimum, and within six (6) months after a spill incident to ensure integrity of the catch basin.
 - Repairs should occur in a timely manner.

- NCDOT should provide annually, a site location map of all hazardous spill catch basins and similar devices to Federal (USEPA, USCG), DENR, State Emergency Response Coordinator, and all applicable county and urban center response groups.
 - Signage indicating the presence of a hazardous spill catch basin shall be provided.
6. The outside wetland or water boundary as well as along the construction corridor within these boundaries approved under this authorization shall be clearly marked by orange fabric fencing for the areas that have been approved to infringe within the wetland or water prior to any land disturbing activities.
 7. NCDOT and its contractors and/or agents shall not excavate, fill, or perform mechanized land clearing at any time in the construction or maintenance of this project within waters and/or wetlands, except as authorized by this Certification, or any modification to this Certification. There shall be no excavation from or waste disposal into jurisdictional wetlands or waters associated with this Certification without appropriate modification. If this occurs, compensatory mitigation will be required since it is a direct impact from road construction activities.
 8. Excavation of stream crossings should be conducted in the dry unless demonstrated by the applicant or its authorized agent to be unfeasible. Sandbags, cofferdams, flexible pipe, or other diversion structures should be used to minimize excavation in flowing water.
 9. Live or fresh concrete shall not come into contact with waters of the state until the concrete has hardened.
 10. Discharging hydroseeding mixtures and washing out hydroseeders and other equipment in or adjacent to surface waters is strictly prohibited.
 11. The removal of vegetation in riparian areas should be minimized. NCDOT is encouraged to use existing on-site vegetation and materials for stream bank stabilization and to minimize the use of rip rap. Riprap shall not be placed in the stream bottom. Riparian vegetation, using native trees and shrubs, must be re-established within the construction limits of the project by the end of the growing season following completion of construction to reestablish the riparian zone and to provide long-term erosion control.
 12. Culverts that are less than 48-inch in diameter should be buried to a depth equal to or greater than 20% of their size to allow for aquatic life passage. Culverts that are 48-inch diameter or larger should be buried at least 12 inches below the stream bottom to allow natural stream bottom material to become established in the culvert following installation and to provide aquatic life passage during periods of low flow. If any of the existing pipes are perched, they shall be removed and replaced, and re-installed correctly, unless demonstrated that this is topographically unfeasible.
 13. Heavy equipment should be operated from the bank rather than in the stream channel unless demonstrated by the applicant or its authorized agent to be unfeasible. All mechanized equipment operated near surface waters should be inspected and maintained regularly to prevent contamination of stream waters from fuels, lubricants, hydraulic fluids or other toxic substances.
 14. *Summary of Compensatory Mitigation:* Compensatory mitigation shall be the same as that approved by the US Army Corps of Engineers, as long as the mitigation required equals a ratio of 1:1 restoration or creation of lost wetland acres as described in 15A NCAC 2H.0506 (h)(6), and consists of the following:

I-2304 Section AA

- 0.02 acres of on-site riverine wetland restoration within I-2304 Section AA
- 2644 linear feet of stream impacts will be mitigated through NCDENR Ecosystem Enhancement Program (EEP).
- 1.08 acres of impacts to non-riverine wetlands will be mitigated through EEP.

I-2304 Section AB

- 1.03 acres of on-site riverine wetland restoration within I-2304 Section AA.
- 1811 linear feet of stream will be mitigated through EEP.
- 0.16 acres of impacts to non-riverine wetlands will be mitigated through EEP.

In accordance with 15A NCAC 2R.0500, this contribution will satisfy NC Division of Water Quality's compensatory mitigation requirements under 15A NCAC 2H.0506(h). Until the EEP receives and clears your payments, wetland or stream fill shall not occur. The payments to EEP shall be sent within two (2) months of issuance of the 404 permit.

15. Rock check dams at culvert outlets should be removed at project completion to avoid blocking movement of aquatic life.
16. Two copies of the final construction drawings shall be furnished to NCDWQ prior to the pre-construction meeting. Written verification shall be provided that the final construction drawings comply with the attached permit drawings contained in the Application dated February 20, 2004.
17. Upon completion of the project, the NCDOT shall complete and return the enclosed "Certification of Completion Form" to notify DWQ when all work included in the 401 Certification has been completed. The responsible party shall complete the attached form and return it to the 401/Wetlands Unit of the Division of Water Quality upon completion of the project.
18. NCDOT and its authorized agents shall conduct its activities in a manner consistent with State water quality standards and any other appropriate requirements of State law and Federal law. If DWQ determines that such standards or laws are not being met (including the failure to sustain a designated or achieved use) or that State or federal law is being violated, or that further conditions are necessary to assure compliance, DWQ may reevaluate and modify this Certification to include conditions appropriate to assure compliance with such standards and requirements in accordance with 15A NCAC 2H.0507(d). Before modifying the Certification, DWQ shall notify NCDOT and the US Army Corps of Engineers, provide public notice in accordance with 15A NCAC 2H.0503 and provide opportunity for public hearing in accordance with 15A NCAC 2H.0504. Any new or revised conditions shall be provided to NCDOT in writing, shall be provided to the United States Army Corps of Engineers for reference in any permit issued pursuant to Section 404 of the Clean Water Act, and shall also become conditions of the 404 Permit for the project.

NCDOT shall require its contractors (and/or agents) to comply with all of the terms of this Certification, and shall provide each of its contractors (and/or agents) a copy of this Certification.

Violations of any condition herein set forth may result in revocation of this Certification and may result in criminal and/or civil penalties. This Certification shall become null and void unless the above conditions are made conditions of the Federal Permit. This Certification shall expire upon the expiration of the 404 Permit.

Gregory J. Thorpe, Ph.D.
§401 Water Quality Certification No. 3455
I-2304 AA and I-2304 BA

If you do not accept any of the conditions of this certification, you may ask for an adjudicatory hearing. You must act within 60 days of the date that you receive this letter. To ask for a hearing, send a written petition that conforms to Chapter 150B of the North Carolina General Statutes to the Office of Administrative Hearings, 6714 Mail Service Center, Raleigh, N.C. 27699-6714. This certification and its conditions are final and binding unless you ask for a hearing.

This the 19th day of March 2004

DIVISION OF WATER QUALITY

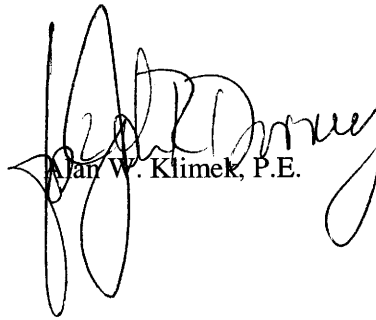

Alan W. Klimek, P.E.

WQC No. 3455

**NORTH CAROLINA – DIVISION OF WATER QUALITY
401 WATER QUALITY CERTIFICATION
SUMMARY OF PERMITTED IMPACTS AND MITIGATION REQUIREMENTS**

In accordance with 15A NCAC 2H.0500, NCDOT, DWQ Project No. 040275, is authorized to impact the surface waters of the State of North Carolina as indicated below for the purpose of improving I-85 from north of SR 2120 in Rowan County to north of I-85 Business in Davidson County. All activities associated with these authorized impacts must be conducted in accordance with the conditions listed in the attached Certification transmittal letter. **THIS CERTIFICATION IS NOT VALID WITHOUT THE ATTACHMENTS.**

Summary of Impacts

I-2304 Section AA

- 0.02 acres of riverine wetlands through excavation and mechanized clearing;
- 1.08 acres of non-riverine wetlands through fill and mechanized clearing;
- 2644 linear feet of jurisdictional stream loss.

I-2304 Section AB

- 1.03 acres of riverine wetlands through fill, excavation, and mechanized clearing.
- 0.16 acres of non-riverine wetlands through fill and mechanized clearing.
- 1811 linear feet of jurisdictional stream loss;
- 0.003 acres of ponds (filling or draining).

On-site mitigation to be performed by NCDOT:

- 0.02 acres of on-site riverine wetland restoration within I-2304 Section AA.
- 1.03 acres of on-site riverine wetland restoration within I-2304 Section AA.

COMPENSATORY MITIGATION REQUIREMENTS:

LOCATION: I-85

COUNTY: Davidson and Rowan Counties

BASIN/SUBBASIN: Yadkin-Pee Dee, Hydrologic Unit 03040103

As required by 15A NCAC 2B .0250 and 15A NCAC 2H .0506(h), and the conditions of this Certification, you are required to compensate for the above impacts through the restoration, creation, enhancement or preservation of wetlands, buffers, and surface waters as outlined below *prior* to conducting any activities that impact or degrade waters of the state. Mitigation to be performed by NC Ecological Enhancement Program in Hydrologic Unit 03040103:

- 4455 linear feet of stream impacts.
- 1.24 acres of impacts to non-riverine wetlands.

One of the options you have available to satisfy the compensatory mitigation requirements is through payment of a fee to the Ecosystem Enhancement Program per 15A NCAC 2R .0503. If you choose this option, please sign this form and mail it to the address listed below. An invoice for the appropriate amount of payment will be sent to you upon receipt of this form. **PLEASE NOTE, THE ABOVE IMPACTS ARE NOT AUTHORIZED UNTIL YOU RECEIVE NOTIFICATION THAT YOUR PAYMENT HAS BEEN PROCESSED BY THE ECOSYSTEM ENHANCEMENT PROGRAM.**

Signature

Date

ECOSYSTEM ENHANCEMENT PROGRAM
1652 Mail Service Center
RALEIGH, NC, 27699-1652



DWQ Project No.: _____ County: _____
Applicant: _____
Project Name: _____
Date of Issuance of 401 Water Quality Certification: _____

Certificate of Completion

Upon completion of all work approved within the 401 Water Quality Certification or applicable Buffer Rules, and any subsequent modifications, the applicant is required to return this certificate to the 401/Wetlands Unit, North Carolina Division of Water Quality, 1650 Mail Service Center, Raleigh, NC, 27699-1650. This form may be returned to DWQ by the applicant, the applicant's authorized agent, or the project engineer. It is not necessary to send certificates from all of these.

Applicant's Certification

I, _____, hereby state that, to the best of my abilities, due care and diligence was used in the observation of the construction such that the construction was observed to be built within substantial compliance and intent of the 401 Water Quality Certification and Buffer Rules, the approved plans and specifications, and other supporting materials.

Signature: _____ Date: _____

Agent's Certification

I, _____, hereby state that, to the best of my abilities, due care and diligence was used in the observation of the construction such that the construction was observed to be built within substantial compliance and intent of the 401 Water Quality Certification and Buffer Rules, the approved plans and specifications, and other supporting materials.

Signature: _____ Date: _____

If this project was designed by a Certified Professional

I, _____, as a duly registered Professional _____ (i.e., Engineer, Landscape Architect, Surveyor, etc.) in the State of North Carolina, having been authorized to observe (periodically, weekly, full time) the construction of the project, for the Permittee hereby state that, to the best of my abilities, due care and diligence was used in the observation of the construction such that the construction was observed to be built within substantial compliance and intent of the 401 Water Quality Certification and Buffer Rules, the approved plans and specifications, and other supporting materials.

Signature _____ Registration No. _____ Date _____





Harvey

November 22, 2004

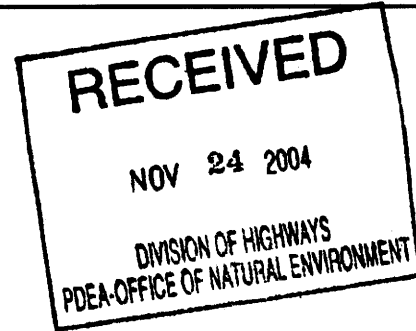

Dr. Gregory J. Thorpe, PhD., Manager
Planning and Environmental Branch
North Carolina Department of Transportation
1548 Mail Service Center
Raleigh, North Carolina, 27699-1548

Re: Modification of 401 Water Quality Certification Pursuant to Section 401 of the Federal Clean Water Act, Individual Permit Improvements to I-85 from north of SR2120 in Rowan County to north of NC 150 in Davidson County, TIP No. I-2304AA and AB
WQC No. 3455

Dear Dr. Thorpe:

Attached hereto is a copy of the Modification of Certification No. 3455 issued to The North Carolina Department of Transportation dated March 19, 2004. If we can be of further assistance, do not hesitate to contact us.

Sincerely,

Alan W. Klimek, P.E.
Director

Attachments

cc: Wilmington District US Army Corps of Engineers
Mr. Eric Alsmeyer, Corps of Engineers Raleigh Field Office
Mr. Christopher Militscher, US Environmental Protection Agency – Region IV
Mr. William Gilmore, P.E. Transition Manager, NC DENR Ecosystem Enhancement Program
Sue Homewood, NC DWQ Winston-Salem Regional Office
Central Files
File Copy

APPROVAL OF 401 Water Quality Certification and ADDITIONAL CONDITIONS

THIS CERTIFICATION is issued in conformity with the requirements of Section 401 Public Laws 92-500 and 95-217 of the United States and subject to the North Carolina Division of Water Quality (DWQ) Regulations in 15 NCAC 2H, Section .0500, and 15 NCAC 2B .0233. This certification authorizes the NCDOT for the following impacts:

Wetland Impacts in the Yadkin-Pee Dee River Basin

Section	Riverine (acres)	Non- Riverine (acres)	Total (acres)	On-Site Wetland Restoration (acres)	Mitigation Required (acres)
Section AA (authorized under original WQC)					
Excavation and Mechanized Clearing	0.02	0	0.02	0.02	0
Fill and Mechanized Clearing	0	1.08	1.08	0	1.08
Subtotal	0.02	1.08	1.10	0.02	1.08
Additional Impacts for this modification					
Fill	0.1	0	0.1	0.1	0
Total Section AA Impacts	0.12	1.08	1.20	0.12	1.08
Section AB (authorized under original WQC)					
Fill, Excavation and Mechanized Clearing	1.03	0	1.03	1.03	0
Fill and Mechanized Clearing	0	0.16	0.16	0	0.16
Subtotal	1.03	0.16	1.19	1.03	0.16
Additional Impacts for this modification					
Fill	0	0	0	0	0
Total Section AB Impacts	1.03	0.16	1.19	1.03	0.16

Surface Water Impacts for the Yadkin-Pee Dee River Basins

Section	Ponds (acres)	Stream Impacts (linear feet)	Stream Impacts (acres)	Stream Impacts Requiring Mitigation (linear feet)	On-Site Natural Channel Design (linear feet)	Mitigation Required
Section AA (authorized under original WQC)	0	2,644	0	2,644	0	2,644
Additional Impacts for this modification	0	0	0.15	0	0	0
Total for Section AA	0	11,104	0.15	11,104	0	2,644
Section AB (authorized under original WQC)	0.003	1,811	0	1,811	0	1,811
Additional Impacts for this modification	0	0	0	0	0	0
Total for Section AB	0.003	1,811	0	1,811	0	1,811

The project shall be constructed pursuant to the application filed on the October 11, 2004. The application provides adequate assurance that the discharge of fill material into the waters of the Yadkin-Pee Dee River Basins in conjunction with the proposed development will not result in a violation of applicable Water Quality Standards and discharge guidelines. Therefore, the State of North Carolina certifies that this activity will not violate the applicable portions of Sections 301, 302, 303, 306, 307 of PL 92-500 and PL 95-217 if conducted in accordance with the application and conditions hereinafter set forth.

This approval is only valid for the purpose and design that you submitted in your application, as described in the Public Notice. Should your project change, you are required to notify the DWQ and submit a new application. If the property is sold, the new owner must be given a copy of this Certification and approval letter, and is thereby responsible for complying with all the conditions. If additional wetland impacts, or stream impacts, for this project (now or in the future) exceed one acre or 150 linear feet, respectively, additional compensatory mitigation may be required as described in 15A NCAC 2H .0506 (h) (6) and (7). For this approval to remain valid, you are required to comply with all the conditions listed below. In addition, you should obtain all other federal, state or local permits before proceeding with your project including (but not limited to) Sediment and Erosion control, Coastal Stormwater, Non-discharge and Water Supply watershed regulations. This Certification shall expire three years from the date of the cover letter from DWQ or on the same day as the expiration date of the corresponding Corps of Engineers Permit, whichever is sooner.

Condition(s) of Certification:

Project Specific Conditions of Certification:

1. We understand that you have chosen to perform compensatory mitigation for impacts to wetlands and streams through an in-lieu payment to the North Carolina Ecosystem Enhancement Program (NCEEP), and that the NCEEP has agreed to implement the mitigation for the project. NCEEP has indicated in a letter dated August 26, 2004 that they will assume responsibility for satisfying the federal Clean Water Act compensatory mitigation requirements for the above-referenced project as detailed in the table below.

Type of Impact	Amount of Impact
Non-Riverine Wetlands	1.24 ac
Streams	4,455 lf

General Conditions of Certification:

2. The dimension, pattern and profile of the stream above and below the crossing should not be modified by widening the stream channel or reducing the depth of the stream. Disturbed floodplains and streams should be restored to natural geomorphic conditions. All stream relocation and restoration activities shall comply with the final natural channel design plans approved by the NC Division of Water Quality.
3. Construction will be conducted in such a manner as to prevent a significant increase in turbidity outside the area of construction or construction-related discharge. Erosion and sediment control practices must be in full compliance with all specifications governing the proper design, installation and operation and maintenance of such Best Management Practices in order to assure compliance with the appropriate turbidity water quality standard.
 - a. The erosion and sediment control measures for the project must equal or exceed the proper design, installation, operation and maintenance outlined in the most recent version of the North Carolina Sediment and Erosion Control Planning and Design Manual. These devices shall be maintained on all construction sites, borrow sites, and waste pile (spoil) projects, including contractor-owned or leased borrow pits associated with the project.
 - b. For borrow pit sites, the erosion and sediment control measures must equal or exceed the proper design, installation, operation and maintenance outlined in the most recent version of the North Carolina Surface Mining Manual. The reclamation measures and implementation must comply with the reclamation in accordance with the requirements of the Sedimentation Pollution Control Act.
4. All sediment and erosion control measures shall not be placed in wetlands or waters to the maximum extent practicable. If placement of sediment and erosion control devices in wetlands and waters is unavoidable, they shall be removed and the natural grade restored after the Division of Land Resources has released the project.
5. If an environmental document is required, this Certification is not valid until a FONSI or ROD is issued by the State Clearinghouse. All water quality-related conditions of the FONSI or ROD shall become conditions of this Certification.

6. No live or fresh concrete shall come into contact with waters of the state until the concrete has hardened.
7. There shall be no excavation from or waste disposal into jurisdictional wetlands or waters associated with this permit without appropriate modification of this permit. Should waste or borrow sites be located in wetlands or stream, compensatory mitigation will be required since it is a direct impact from road construction activities.
8. Excavation of the stream crossings should be conducted in the dry. Sandbags, cofferdams, flexible pipe, or other diversion structures should be used to minimize excavation in flowing water.
9. All channel relocations will be constructed in a dry work area, and stabilized before stream flows are diverted. Channel relocations will be completed and stabilized prior to diverting water into the new channel. Whenever possible, channel relocations shall be allowed to stabilize for an entire growing season. Vegetation used for bank stabilization shall be limited to native woody species, and should include establishment of a 30 foot wide wooded and an adjacent 20 foot wide vegetated buffer on both sides of the relocated channel to the maximum extent practical. A transitional phase incorporating coir fiber and seedling establishment is allowable. Also, rip-rap may be allowed if it is necessary to maintain the physical integrity of the stream, but the applicant must provide written justification and any calculations used to determine the extent of rip-rap coverage requested.
10. Upon completion of the project, the NCDOT shall complete and return the enclosed "Certification of Completion Form" to notify DWQ when all work included in the 401 Certification has been completed. The responsible party shall complete the attached form and return it to the 401/Wetlands Unit of the Division of Water Quality upon completion of the project.
11. Placement of culverts and other structures in waters, streams, and wetlands must be placed below the elevation of the streambed to allow low flow passage of water and aquatic life unless it can be shown to DWQ that providing passage would be impractical. Design and placement of culverts and other structures including temporary erosion control measures shall not be conducted in a manner that may result in dis-equilibrium of wetlands or streambeds or banks, adjacent to or upstream and down stream of the above structures. The applicant is required to provide evidence that the equilibrium shall be maintained if requested in writing by DWQ.
12. During the construction of the project, no staging of equipment of any kind is permitted in waters of the U.S., or protected riparian buffers.
13. All temporary fills in wetlands and surface waters shall be removed upon completion of the project. In addition, the post-construction removal of any temporary bridge structures or fill will need to return the project site to its preconstruction contours and elevations. The revegetation of the impacted areas with appropriate native species will be required.
14. Riparian vegetation must be reestablished within the construction limits of the project by the end of the growing season following completion of construction.
15. Any riprap used must not interfere with thalweg performance and aquatic life passage during low flow conditions.

16. Heavy equipment should be operated from the bank rather than in the stream channel whenever possible in order to minimize sedimentation and reduce the likelihood of introducing other pollutants into the stream. All mechanized equipment operated near surface waters must be regularly inspected and maintained to prevent contamination of stream waters from fuels, lubricants, hydraulic fluids, or other toxic materials.
17. Discharging hydroseed mixtures and washing out hydroseeders and other equipment in or adjacent to surface waters is prohibited.
18. Two copies of the final construction drawings shall be furnished to NCDWQ prior to the pre-construction meeting. Written verification shall be provided that the final construction drawings comply with the attached permit drawings contained in the application dated May 11, 2004.
19. The outside buffer, wetland or water boundary located within the construction corridor approved by this authorization shall be clearly marked by orange fabric fencing prior to any land disturbing activities. Impacts to areas within the fencing are prohibited unless otherwise authorized by this certification.
20. NCDOT, and its authorized agents, shall conduct its activities in a manner consistent with State water quality standards (including any requirements resulting from compliance with §303(d) of the Clean Water Act) and any other appropriate requirements of State law and Federal law. If DWQ determines that such standards or laws are not being met (including the failure to sustain a designated or achieved use) or that State or federal law is being violated, or that further conditions are necessary to assure compliance, DWQ may reevaluate and modify this certification to include conditions appropriate to assure compliance with such standards and requirements in accordance with 15A NCAC 2H.0507(d). Before modifying the certification, DWQ shall notify NCDOT and the US Army Corps of Engineers, provide public notice in accordance with 15A NCAC 2H.0503 and provide opportunity for public hearing in accordance with 15A NCAC 2H.0504. Any new or revised conditions shall be provided to NCDOT in writing, shall be provided to the United States Army Corps of Engineers for reference in any permit issued pursuant to Section 404 of the Clean Water Act, and shall also become conditions of the 404 Permit for the project.
21. A copy of this Water Quality Certification shall be posted on the construction site at all times. In addition, the Water Quality Certification (and all subsequent modifications, if any, shall be maintained with the Division Engineer and the on-site project manager.
22. Culverts that are less than 48-inch in diameter should be buried to a depth equal to or greater than 20% of their size to allow for aquatic life passage. Culverts that are 48-inch in diameter or larger should be buried at least 12 inches below the stream bottom to allow natural stream bottom material to become established in the culvert following installation and to provide aquatic life passage during periods of low flow. These measurements must be based on natural thalweg depths.
23. All the authorized activities and conditions of certification associated with the original Water Quality Certification dated March 19, 2004 and all other corresponding modifications still apply except where superseded by this certification.

Violations of any condition herein set forth may result in revocation of this Certification and may result in criminal and/or civil penalties. This Certification shall become null and void unless the above conditions are made conditions of the Federal 404 and/or Coastal Area Management Act Permit. This Certification shall expire upon the expiration of the 404 or CAMA permit.

If this Certification is unacceptable to you have the right to an adjudicatory hearing upon written request within sixty (60) days following receipt of this Certification. This request must be in the form of a written petition conforming to Chapter 150B of the North Carolina General Statutes and filed with the Office of Administrative Hearings, P.O. Box 27447, Raleigh, N.C. 27611-7447. If modifications are made to an original Certification, you have the right to an adjudicatory hearing on the modifications upon written request within sixty (60) days following receipt of the Certification. Unless such demands are made, this Certification shall be final and binding.

This the 22nd day of November 2004

DIVISION OF WATER QUALITY

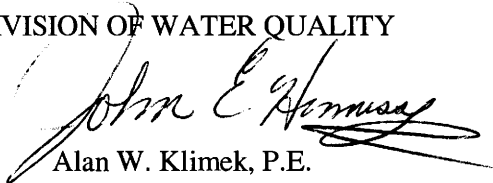
A handwritten signature in black ink, appearing to read "Alan W. Klimek", is written over the typed name and title. The signature is stylized and includes a large flourish at the end.

Alan W. Klimek, P.E.
Director

WQC No. 3455

DWQ Project No.: _____ County: _____

Applicant: _____

Project Name: _____

Date of Issuance of 401 Water Quality Certification: _____

Certificate of Completion

Upon completion of all work approved within the 401 Water Quality Certification or applicable Buffer Rules, and any subsequent modifications, the applicant is required to return this certificate to the 401/Wetlands Unit, North Carolina Division of Water Quality, 1621 Mail Service Center, Raleigh, NC, 27699-1621. This form may be returned to DWQ by the applicant, the applicant's authorized agent, or the project engineer. It is not necessary to send certificates from all of these.

Applicant's Certification

I, _____, hereby state that, to the best of my abilities, due care and diligence was used in the observation of the construction such that the construction was observed to be built within substantial compliance and intent of the 401 Water Quality Certification and Buffer Rules, the approved plans and specifications, and other supporting materials.

Signature: _____ Date: _____

Agent's Certification

I, _____, hereby state that, to the best of my abilities, due care and diligence was used in the observation of the construction such that the construction was observed to be built within substantial compliance and intent of the 401 Water Quality Certification and Buffer Rules, the approved plans and specifications, and other supporting materials.

Signature: _____ Date: _____

Engineer's Certification

_____ Partial _____ Final

I, _____, as a duly registered Professional Engineer in the State of North Carolina, having been authorized to observe (periodically, weekly, full time) the construction of the project, for the Permittee hereby state that, to the best of my abilities, due care and diligence was used in the observation of the construction such that the construction was observed to be built within substantial compliance and intent of the 401 Water Quality Certification and Buffer Rules, the approved plans and specifications, and other supporting materials.

Signature _____

Registration No. _____

Date _____



REPLY TO
ATTENTION OF:

DEPARTMENT OF THE ARMY
WILMINGTON DISTRICT, CORPS OF ENGINEERS
P.O. BOX 1890
WILMINGTON, NORTH CAROLINA 28402-1890

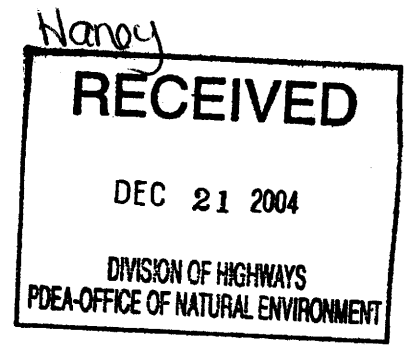

December 16, 2004

Regulatory Division

Subject: Action ID. 199821203; TIP No. I-2304A

Dr. Gregory J. Thorpe, Ph.D.
Environmental Management Director, PDEA
N.C. Department of Transportation
1548 Mail Service Center
Raleigh, NC 27699-1548

Dear Mr. Thorpe:

In accordance with the written request of February 20, 2004, and the ensuing administrative record, enclosed is a permit to authorize the discharge of fill material into waters of the United States, for construction of Section A of the Interstate 85 (I-85) Improvements (T.I.P. No. I-2304A), from north of SR 2120 (Exit 81), northeast of Spencer, in Rowan County, to north of I-85 Business (Exit 87), southwest of Lexington, in Davidson County, North Carolina, crossing the Yadkin River, Potts Creek, and unnamed tributaries.

If any change in the authorized work is required because of unforeseen or altered conditions or for any other reason, the plans revised to show the change must be sent promptly to this office. Such action is necessary, as revised plans must be reviewed and the permit modified.

Carefully read your permit. The general and special conditions are important. Your failure to comply with these conditions could result in a violation of Federal law. Certain significant general conditions require that:

- a. You must complete construction before December 31, 2009.
- b. You must notify this office in advance as to when you intend to commence and complete work.
- c. You must allow representatives from this office to make periodic visits to your worksite as deemed necessary to assure compliance with permit plans and conditions.

Should you have questions, contact Mr. Eric Alsmeyer of my Raleigh Field Office regulatory staff at telephone (919) 876-8441, extension 23.

Sincerely,

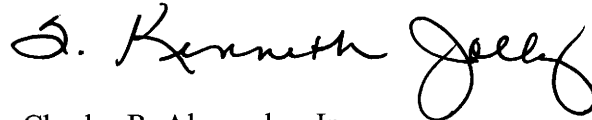

for Charles R. Alexander, Jr.
Colonel, U.S. Army
District Engineer

Enclosures

Copy Furnished with enclosures:

Chief, Source Data Unit
NOAA/National Ocean Service
ATTN: Sharon Tear N/CS261
1315 East-West Hwy., Rm 7316
Silver Spring, MD 20910-3282

Copies Furnished with special conditions and plans:

Mr. Pete Benjamin, Field Supervisor
U.S. Fish and Wildlife Service
Fish and Wildlife Enhancement
Post Office Box 33726
Raleigh, North Carolina 27636-3726

Mr. Ron Sechler
National Marine Fisheries
Service, NOAA
Pivers Island
Beaufort, North Carolina 28516

Mr. David Rackley
National Marine Fisheries
Service, NOAA
219 Fort Johnson Road
Charleston, South Carolina 29412-9110

•
* Mr. Ronald Mikulak, Chief
Wetlands Section - Region IV
Water Management Division
U.S. Environmental Protection Agency
Atlanta Federal Center
61 Forsyth Street, SW
Atlanta, Georgia 30303

Mr. Doug Huggett
NC Division of Coastal Management
Division of Coastal Management
151-B, NC Hwy 24
Morehead City, NC 2855

Mr. William D. Gilmore, P.E.
EEP Transition Manager
Ecosystem Enhancement Center
1652 Mail Service Center
Raleigh, NC 27699-1652

DEPARTMENT OF THE ARMY PERMIT

RECEIVED

NC Department of Transportation

DEC 14 2004

Permittee _____

199821203

Permit No. _____

USAED, Wilmington

Issuing Office _____

REGULATORY
WLM, FLD, CFC.

NOTE: The term "you" and its derivatives, as used in this permit, means the permittee or any future transferee. The term "this office" refers to the appropriate district or division office of the Corps of Engineers having jurisdiction over the permitted activity or the appropriate official of that office acting under the authority of the commanding officer.

You are authorized to perform work in accordance with the terms and conditions specified below.

Project Description:

Place fill material impacting a total of 2.29 acres of wetlands and 4,455 linear feet of stream, for construction of Section A of the Interstate 85 (I-85) Improvements (T.I.P. No. I-2304A), crossing the Yadkin River, Potts Creek, and unnamed tributaries.

Project Location:

From north of SR 2120 (Exit 81), northeast of Spencer, in Rowan County, to north of I-85 Business (Exit 87), southwest of Lexington, in Davidson County, North Carolina.

Permit Conditions:

General Conditions:

1. The time limit for completing the work authorized ends on December 31, 2009. If you find that you need more time to complete the authorized activity, submit your request for a time extension to this office for consideration at least one month before the above date is reached.
2. You must maintain the activity authorized by this permit in good condition and in conformance with the terms and conditions of this permit. You are not relieved of this requirement if you abandon the permitted activity, although you may make a good faith transfer to a third party in compliance with General Condition 4 below. Should you wish to cease to maintain the authorized activity or should you desire to abandon it without a good faith transfer, you must obtain a modification of this permit from this office, which may require restoration of the area.
3. If you discover any previously unknown historic or archeological remains while accomplishing the activity authorized by this permit, you must immediately notify this office of what you have found. We will initiate the Federal and state coordination required to determine if the remains warrant a recovery effort or if the site is eligible for listing in the National Register of Historic Places.

4. If you sell the property associated with this permit, you must obtain the signature of the new owner in the space provided and forward a copy of the permit to this office to validate the transfer of this authorization.
5. If a conditioned water quality certification has been issued for your project, you must comply with the conditions specified in the certification as special conditions to this permit. For your convenience, a copy of the certification is attached if it contains such conditions.
6. You must allow representatives from this office to inspect the authorized activity at any time deemed necessary to ensure that it is being or has been accomplished in accordance with the terms and conditions of your permit.

Special Conditions:

See enclosed sheet.

Further Information:

1. **Congressional Authorities:** You have been authorized to undertake the activity described above pursuant to:
 - () Section 10 of the Rivers and Harbors Act of 1899 (33 U.S.C. 403).
 - (X) Section 404 of the Clean Water Act (33 U.S.C. 1344).
 - () Section 103 of the Marine Protection, Research and Sanctuaries Act of 1972 (33 U.S.C. 1413).
2. **Limits of this authorization.**
 - a. This permit does not obviate the need to obtain other Federal, state, or local authorizations required by law.
 - b. This permit does not grant any property rights or exclusive privileges.
 - c. This permit does not authorize any injury to the property or rights of others.
 - d. This permit does not authorize interference with any existing or proposed Federal project.
3. **Limits of Federal Liability.** In issuing this permit, the Federal Government does not assume any liability for the following:
 - a. Damages to the permitted project or uses thereof as a result of other permitted or unpermitted activities or from natural causes.
 - b. Damages to the permitted project or uses thereof as a result of current or future activities undertaken by or on behalf of the United States in the public interest.
 - c. Damages to persons, property, or to other permitted or unpermitted activities or structures caused by the activity authorized by this permit.
 - d. Design or construction deficiencies associated with the permitted work.



1998 21 203
COPY RECEIVED

Michael F. Easley, Governor
William G. Ross Jr., Secretary
North Carolina Department of Environment and Natural Resources

Alan W. Klimek, P.E., Director
Division of Water Quality
Coleen H. Sullins, Deputy Director
Division of Water Quality

APR 9 1 2004

March 19, 2004

RALEIGH REGULATORY FIELD OFFICE

Mr. Gregory J. Thorpe, Ph.D., Environmental Director
NCDOT Planning and Environmental Branch
1548 Mail Service Center
Raleigh, NC, 27699-1548

Dear Dr. Thorpe:

Re: Water Quality Certification Pursuant to §401 of the Federal Clean Water Act.
Improvements to I-85 from north of SR 2120 in Rowan County to north of I-85 Business in Davidson County.
F.A. Project No. NHF-85-3(164)80; State Project No. 8.1631403
TIP No. I-2304AA and I-2304AB
DWQ Project No. 040275

Attached hereto is a copy of Certification No. 3455 issued to The North Carolina Department of Transportation dated March 19, 2004.

If we can be of further assistance, do not hesitate to contact us.

Sincerely,

Alan W. Klimek, P.E.

Attachments

cc: Wilmington District Corps of Engineers
Eric Alsmeyer, USACE Raleigh Field Office
NCDWQ Winston-Salem Regional Office
Christopher Militscher, US Environmental Protection Agency – Region IV
William Gilmore, NC Ecological Enhancement Program
Central Files
File Copy



NORTH CAROLINA 401 WATER QUALITY CERTIFICATION

THIS CERTIFICATION is issued in conformity with the requirements of Section 401 Public Laws 92-500 and 95-217 of the United States and subject to the North Carolina Division of Water Quality (DWQ) Regulations in 15 NCAC 2H, .0500. This Certification authorizes the NCDOT to incur the following permanent impacts:

I-2304 Section AA

- 0.02 acres of riverine wetlands through excavation and mechanized clearing;
- 1.08 acres of non-riverine wetlands through fill and mechanized clearing;
- 2644 linear feet of jurisdictional stream loss.

I-2304 Section AB

- 1.03 acres of riverine wetlands through fill, excavation, and mechanized clearing.
- 0.16 acres of non-riverine wetlands through fill and mechanized clearing.
- 1811 linear feet of jurisdictional stream loss;
- 0.003 acres of ponds (filling or draining).

The I-2304AA and I-2304AB projects shall be constructed pursuant to the application dated February 20, 2004 to improve I-85 from north of SR 2120 in Rowan County to north of I-85 Business in Davidson County.

The Application provides adequate assurance that the discharge of fill material into the waters of the state with the proposed development will not result in a violation of applicable Water Quality Standards and discharge guidelines. Therefore, the State of North Carolina certifies that this activity will not violate the applicable portions of Sections 301, 302, 303, 306, 307 of PL 92-500 and PL 95-217 if conducted in accordance with the application and conditions hereinafter set forth.

This approval is only valid for the purpose and design that you submitted in your Application. All work authorized by this Certification must be done in strict compliance with the plans attached to the Application. If this project changes, incurring additional impacts to streams, wetlands or buffers, you are required to notify the DWQ *in writing*, and you may be required to submit a new application. Additional compensatory mitigation may be required as described in 15A NCAC 2H .0506 (h) (6) and (7). For this approval to remain valid, you are required to comply with all the conditions listed below. In addition, you should obtain all other federal, state or local permits before proceeding with your project including (but not limited to) Sediment and Erosion Control, Non-discharge and Water Supply watershed regulations.

This Certification shall expire three (3) years from the date of the cover letter from DWQ or on the same day as the expiration date of the corresponding US Army Corps of Engineers Permit, whichever is later.

Condition(s) of Certification:

1. Erosion and sediment control practices must be in full compliance with all specifications governing the proper design, installation and operation and maintenance of such Best Management Practices in order to protect surface waters standards:
 - a. The erosion and sediment control measures for the project must be designed, installed, operated, and maintained in accordance with the most recent version of the *North Carolina Sediment and Erosion Control Planning and Design Manual*.
 - b. The design, installation, operation, and maintenance of the sediment and erosion control measures must be such that they equal, or exceed, the requirements specified in the most recent version of the *North Carolina Sediment and Erosion Control Manual*. The devices shall be maintained on all construction sites, borrow sites, and waste pile (spoil) projects, including contractor-owned or leased borrow pits associated with the project.
 - c. For borrow pit sites, the erosion and sediment control measures must be designed, installed, operated, and maintained in accordance with the most recent version of the *North Carolina Surface Mining Manual*.
 - d. Any reclamation measures and implementation must comply with the reclamation in accordance with the requirements of the Sedimentation Pollution Control Act.
2. No waste, spoil, solids, or fill of any kind shall occur in wetlands, waters, or riparian areas beyond the footprint of the impacts depicted in the Application. All construction activities shall be performed so that no violations of state water quality standards, statutes, or rules occur.
3. Sediment and erosion control measures shall not be placed in wetlands or waters to the maximum extent practicable. If placement of sediment and erosion control devices in wetlands and waters is unavoidable, they shall be removed and the natural grade restored within 30 days after the project has been released.
4. Stormwater management shall be constructed in accordance with the hydraulic design plans submitted in the February 20, 2004 application.
5. The hazardous spill catch basins (I-2304AA Plan Sheet 9) shall be designed and located to afford ready access to maintenance and emergency response personnel and equipment.
 - The volume of spill containment storage provided will be approximately 10,000 gallons plus the estimated runoff volume from rainfall intensity equating to a two-year return period event.
 - A means will be provided such that the normal free flow of runoff at the basin outlet can be interrupted to cause containment of hazardous runoff. This can be accomplished by providing a mechanical control gate or by constructing a minimum control section in the outlet channel. The mechanical gate alternative will generally be utilized in areas where normal operational activities would allow close scrutiny and control, reducing the potential for problems with vandalism.
 - Maintenance plans for constructed basins shall be developed in accordance with Best Management Practices (BMPs) and good engineering practices. Additional guidance for properly maintaining containment basins can be found at 40 CFR Part 112, §112.7, *et al.* (Spill Prevention Control and Countermeasures).
 - Inspections of the hazardous spill catch basin and opening/shutting of the gate should be performed annually at a minimum, and within six (6) months after a spill incident to ensure integrity of the catch basin.
 - Repairs should occur in a timely manner.

- NCDOT should provide annually, a site location map of all hazardous spill catch basins and similar devices to Federal (USEPA, USCG), DENR, State Emergency Response Coordinator, and all applicable county and urban center response groups.
 - Signage indicating the presence of a hazardous spill catch basin shall be provided.
6. The outside wetland or water boundary as well as along the construction corridor within these boundaries approved under this authorization shall be clearly marked by orange fabric fencing for the areas that have been approved to infringe within the wetland or water prior to any land disturbing activities.
 7. NCDOT and its contractors and/or agents shall not excavate, fill, or perform mechanized land clearing at any time in the construction or maintenance of this project within waters and/or wetlands, except as authorized by this Certification, or any modification to this Certification. There shall be no excavation from or waste disposal into jurisdictional wetlands or waters associated with this Certification without appropriate modification. If this occurs, compensatory mitigation will be required since it is a direct impact from road construction activities.
 8. Excavation of stream crossings should be conducted in the dry unless demonstrated by the applicant or its authorized agent to be unfeasible. Sandbags, cofferdams, flexible pipe, or other diversion structures should be used to minimize excavation in flowing water.
 9. Live or fresh concrete shall not come into contact with waters of the state until the concrete has hardened.
 10. Discharging hydroseeding mixtures and washing out hydroseeders and other equipment in or adjacent to surface waters is strictly prohibited.
 11. The removal of vegetation in riparian areas should be minimized. NCDOT is encouraged to use existing on-site vegetation and materials for stream bank stabilization and to minimize the use of rip rap. Riprap shall not be placed in the stream bottom. Riparian vegetation, using native trees and shrubs, must be re-established within the construction limits of the project by the end of the growing season following completion of construction to reestablish the riparian zone and to provide long-term erosion control.
 12. Culverts that are less than 48-inch in diameter should be buried to a depth equal to or greater than 20% of their size to allow for aquatic life passage. Culverts that are 48-inch diameter or larger should be buried at least 12 inches below the stream bottom to allow natural stream bottom material to become established in the culvert following installation and to provide aquatic life passage during periods of low flow. If any of the existing pipes are perched, they shall be removed and replaced, and re-installed correctly, unless demonstrated that this is topographically unfeasible.
 13. Heavy equipment should be operated from the bank rather than in the stream channel unless demonstrated by the applicant or its authorized agent to be unfeasible. All mechanized equipment operated near surface waters should be inspected and maintained regularly to prevent contamination of stream waters from fuels, lubricants, hydraulic fluids or other toxic substances.
 14. *Summary of Compensatory Mitigation:* Compensatory mitigation shall be the same as that approved by the US Army Corps of Engineers, as long as the mitigation required equals a ratio of 1:1 restoration or creation of lost wetland acres as described in 15A NCAC 2H.0506 (h)(6), and consists of the following:

I-2304 Section AA

- 0.02 acres of on-site riverine wetland restoration within I-2304 Section AA
- 2644 linear feet of stream impacts will be mitigated through NCDENR Ecosystem Enhancement Program (EEP).
- 1.08 acres of impacts to non-riverine wetlands will be mitigated through EEP.

I-2304 Section AB

- 1.03 acres of on-site riverine wetland restoration within I-2304 Section AA.
- 1811 linear feet of stream will be mitigated through EEP.
- 0.16 acres of impacts to non-riverine wetlands will be mitigated through EEP.

In accordance with 15A NCAC 2R.0500, this contribution will satisfy NC Division of Water Quality's compensatory mitigation requirements under 15A NCAC 2H.0506(h). Until the EEP receives and clears your payments, wetland or stream fill shall not occur. The payments to EEP shall be sent within two (2) months of issuance of the 404 permit.

15. Rock check dams at culvert outlets should be removed at project completion to avoid blocking movement of aquatic life.
16. Two copies of the final construction drawings shall be furnished to NCDWQ prior to the pre-construction meeting. Written verification shall be provided that the final construction drawings comply with the attached permit drawings contained in the Application dated February 20, 2004.
17. Upon completion of the project, the NCDOT shall complete and return the enclosed "Certification of Completion Form" to notify DWQ when all work included in the 401 Certification has been completed. The responsible party shall complete the attached form and return it to the 401/Wetlands Unit of the Division of Water Quality upon completion of the project.
18. NCDOT and its authorized agents shall conduct its activities in a manner consistent with State water quality standards and any other appropriate requirements of State law and Federal law. If DWQ determines that such standards or laws are not being met (including the failure to sustain a designated or achieved use) or that State or federal law is being violated, or that further conditions are necessary to assure compliance, DWQ may reevaluate and modify this Certification to include conditions appropriate to assure compliance with such standards and requirements in accordance with 15A NCAC 2H.0507(d). Before modifying the Certification, DWQ shall notify NCDOT and the US Army Corps of Engineers, provide public notice in accordance with 15A NCAC 2H.0503 and provide opportunity for public hearing in accordance with 15A NCAC 2H.0504. Any new or revised conditions shall be provided to NCDOT in writing, shall be provided to the United States Army Corps of Engineers for reference in any permit issued pursuant to Section 404 of the Clean Water Act, and shall also become conditions of the 404 Permit for the project.

NCDOT shall require its contractors (and/or agents) to comply with all of the terms of this Certification, and shall provide each of its contractors (and/or agents) a copy of this Certification.

Violations of any condition herein set forth may result in revocation of this Certification and may result in criminal and/or civil penalties. This Certification shall become null and void unless the above conditions are made conditions of the Federal Permit. This Certification shall expire upon the expiration of the 404 Permit.

Gregory J. Thorpe, Ph.D.
§401 Water Quality Certification No. 3455
I-2304 AA and I-2304 BA

If you do not accept any of the conditions of this certification, you may ask for an adjudicatory hearing. You must act within 60 days of the date that you receive this letter. To ask for a hearing, send a written petition that conforms to Chapter 150B of the North Carolina General Statutes to the Office of Administrative Hearings, 6714 Mail Service Center, Raleigh, N.C. 27699-6714. This certification and its conditions are final and binding unless you ask for a hearing.

This the 19th day of March 2004

DIVISION OF WATER QUALITY

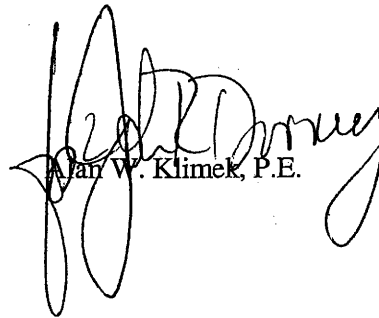

Alan W. Klimek, P.E.

WQC No. 3455

**NORTH CAROLINA – DIVISION OF WATER QUALITY
401 WATER QUALITY CERTIFICATION
SUMMARY OF PERMITTED IMPACTS AND MITIGATION REQUIREMENTS**

In accordance with 15A NCAC 2H.0500, NCDOT, DWQ Project No. 040275, is authorized to impact the surface waters of the State of North Carolina as indicated below for the purpose of improving I-85 from north of SR 2120 in Rowan County to north of I-85 Business in Davidson County. All activities associated with these authorized impacts must be conducted in accordance with the conditions listed in the attached Certification transmittal letter. **THIS CERTIFICATION IS NOT VALID WITHOUT THE ATTACHMENTS.**

Summary of Impacts

I-2304 Section AA

- 0.02 acres of riverine wetlands through excavation and mechanized clearing;
- 1.08 acres of non-riverine wetlands through fill and mechanized clearing;
- 2644 linear feet of jurisdictional stream loss.

I-2304 Section AB

- 1.03 acres of riverine wetlands through fill, excavation, and mechanized clearing.
- 0.16 acres of non-riverine wetlands through fill and mechanized clearing.
- 1811 linear feet of jurisdictional stream loss;
- 0.003 acres of ponds (filling or draining).

On-site mitigation to be performed by NCDOT:

- 0.02 acres of on-site riverine wetland restoration within I-2304 Section AA.
- 1.03 acres of on-site riverine wetland restoration within I-2304 Section AA.

COMPENSATORY MITIGATION REQUIREMENTS:

LOCATION: I-85
COUNTY: Davidson and Rowan Counties
BASIN/SUBBASIN: Yadkin-Pee Dee, Hydrologic Unit 03040103

As required by 15A NCAC 2B .0250 and 15A NCAC 2H .0506(h), and the conditions of this Certification, you are required to compensate for the above impacts through the restoration, creation, enhancement or preservation of wetlands, buffers, and surface waters as outlined below *prior* to conducting any activities that impact or degrade waters of the state. Mitigation to be performed by NC Ecological Enhancement Program in Hydrologic Unit 03040103:

- 4455 linear feet of stream impacts.
- 1.24 acres of impacts to non-riverine wetlands.

One of the options you have available to satisfy the compensatory mitigation requirements is through payment of a fee to the Ecosystem Enhancement Program per 15A NCAC 2R .0503. If you choose this option, please sign this form and mail it to the address listed below. An invoice for the appropriate amount of payment will be sent to you upon receipt of this form. **PLEASE NOTE, THE ABOVE IMPACTS ARE NOT AUTHORIZED UNTIL YOU RECEIVE NOTIFICATION THAT YOUR PAYMENT HAS BEEN PROCESSED BY THE ECOSYSTEM ENHANCEMENT PROGRAM.**

Signature

Date

ECOSYSTEM ENHANCEMENT PROGRAM
1652 Mail Service Center
RALEIGH, NC, 27699-1652

SPECIAL CONDITIONS (Action ID. 199821203; NCDOT/TIP I-2304A)

COMPLIANCE WITH PLANS

a) All work must be performed in strict compliance with the attached plans, which are a part of this permit. Any modification to the permit plans must be approved by the US Army Corps of Engineers (USACE) prior to implementation.

ACTIVITIES NOT AUTHORIZED

b) Except as authorized by this permit or any USACE approved modification to this permit, no excavation, fill, or mechanized land-clearing activities shall take place at any time in the construction or maintenance of this project, within waters or wetlands, nor shall any activities take place that cause the degradation of waters or wetlands. In addition, except as specified in the plans attached to this permit, no excavation, fill or mechanized land-clearing activities shall take place at any time in the construction or maintenance of this project, in such a manner as to impair normal flows and circulation patterns within, into, or out of waters or wetlands or to reduce the reach of waters or wetlands.

This permit does not authorize temporary placement or double handling of excavated or fill material within jurisdictional waters, including wetlands, outside the permitted area. Additionally, no construction materials or equipment will be placed or stored within jurisdictional waters, including wetlands.

CONSTRUCTION PLANS

c) The permittee will ensure that the construction design plans for this project do not deviate from the permit plans attached to this authorization. Written verification shall be provided that the final construction drawings comply with the attached permit drawings prior to any active construction in waters of the United States, including wetlands. Any deviation in the construction design plans will be brought to the attention of the Corps of Engineers, Raleigh Regulatory Field Office prior to any active construction in waters or wetlands.

d) Prior to commencing construction within jurisdictional waters of the United States for any portion of the proposed project, the permittee shall forward the latest version of project construction drawings to the Corps of Engineers, Raleigh Regulatory Field Office NCDOT Regulatory Project Manager. Half-size drawings will be acceptable.

POLLUTION SPILLS

e) All mechanized equipment will be regularly inspected and maintained to prevent contamination of waters and wetlands from fuels, lubricants, hydraulic fluids, or other

toxic materials. No equipment staging or storage of construction material will occur in wetlands. Hydro-seeding equipment will not be discharged or washed out into any surface waters or wetlands. In the event of a spill of petroleum products or any other hazardous waste, the permittee shall immediately report it to the N.C. Division of Water Quality at (919) 733-5083 or (800) 662-7956 and provisions of the North Carolina Oil Pollution and Hazardous Substances Control Act will be followed.

CLEAN FILL MATERIAL

f) Unless otherwise authorized by this permit, all fill material placed in waters or wetlands shall be generated from an upland source and will be clean and free of any pollutants except in trace quantities. Metal products, organic materials (including debris from land clearing activities), or unsightly debris will not be used.

CONTRACTOR COMPLIANCE

g) The permittee shall require its contractors and/or agents to comply with the terms and conditions of this permit in the construction and maintenance of this project, and shall provide each of its contractors and/or agents associated with the construction or maintenance of this project with a copy of this permit, and any authorized modifications. A copy of this permit, and any authorized modifications, including all conditions, shall be available at the project site during construction and maintenance of this project.

SEDIMENTATION AND EROSION CONTROL MEASURES

h) The permittee shall use appropriate sediment and erosion control practices which equal or exceed those outlined in the most recent version of the "North Carolina Sediment and Erosion Control Planning and Design Manual" to assure compliance with the appropriate turbidity water quality standard. . Erosion and sediment control practices must be in full compliance with all specifications governing the proper design, installation and operation and maintenance of such Best Management Practices in order to assure compliance with the appropriate turbidity water quality standards. Additionally, the project must remain in full compliance with all aspects of the Sedimentation Pollution Control Act of 1973 (North Carolina General Statutes Chapter 113A Article 4).

Adequate sedimentation and erosion control measures must be implemented prior to any ground disturbing activities to minimize impacts to downstream aquatic resources. These measures must be inspected and maintained regularly, especially following rainfall events. All fill material must be adequately stabilized at the earliest practicable date to prevent sediment from entering into adjacent waters or wetlands.

The permittee shall remove all sediment and erosion control measures placed in wetlands or waters, and shall restore natural grades in those areas, prior to project completion.

During the clearing phase of the project, heavy equipment must not be operated in surface waters or stream channels. Temporary stream crossings will be used to access the opposite sides of stream channels. All temporary diversion channels and stream crossings will be constructed of nonerodable materials. Grubbing of riparian vegetation will not occur until immediately before construction begins on a given segment of stream channel.

REPORTING OF VIOLATIONS

i) The permittee will report any violation of these conditions or violations of Section 404 of the Clean Water Act or Section 10 of the Rivers and Harbors Act in writing to the Wilmington District, U. S Army Corps of Engineers, within 24 hours of the permittee's discovery of the violation.

COMPLIANCE WITH SPECIAL CONDITIONS

j) Failure to institute and carry out the details of the following special conditions, below, will result in a directive to cease all ongoing and permitted work within waters and/or wetlands associated with the permitted project, or such other remedies and/or fines as the District Engineer or his authorized representatives may seek.

WET CONCRETE

k) The permittee shall take measures to prevent live or fresh concrete from coming into contact with any surface waters until the concrete has hardened.

CULVERTS

l) All authorized culverts will be installed to allow the passage of low stream flows and the continued movement of fish and other aquatic life as well as to prevent headcutting of the streambed. For all box culverts and for pipes greater than 48 inches in diameter, the bottom of the pipe will be buried at least one foot below the bed of the stream unless burial would be impractical and the Corps of Engineers has waived this requirement. For culverts 48 inches in diameter or smaller, the bottom of the pipe must be buried below the bed of the stream to a depth equal to or greater than 20 percent of the diameter of the culvert. Design and placement of culverts and other structures including temporary erosion control measures shall not be conducted in a manner that may result in disequilibrium of wetlands or streambeds or banks, adjacent to, upstream or downstream of the structures. In order to allow for the continued movement of bed load and aquatic organisms, existing stream channel widths and depths will be maintained at the inlet and outlet ends of culverts. Riprap armoring of streams at culvert inlets and outlets shall be minimized above the ordinary high water elevation in favor of bioengineering techniques such as bank sloping, erosion control matting and revegetation with deep-rooted, woody plants.

PRECONSTRUCTION MEETING

m) The permittee shall schedule a preconstruction meeting between its representatives, the contractor's representatives, and the Corps of Engineers, Raleigh Regulatory Field Office, NCDOT Regulatory Project Manager, prior to any work within jurisdictional waters and wetlands to ensure that there is a mutual understanding of all of the terms and conditions contained within this Department of the Army Permit. The permittee shall provide the USACE, Raleigh Regulatory Field Office, NCDOT Regulatory Project Manager, with a copy of the final plans at least two weeks prior to the preconstruction meeting along with a description of any changes that have been made to the project's design, construction methodology or construction timeframe. The permittee shall schedule the preconstruction meeting for a time when the USACE and North Carolina Division of Water Quality (NCDWQ) Project Managers can attend. The permittee shall invite the Corps and NCDWQ Project Managers a minimum of thirty (30) days in advance of the scheduled meeting in order to provide those individuals with ample opportunity to schedule and participate in the required meeting.

BORROW AND WASTE

n) To ensure that all borrow and waste activities occur on high ground and do not result in the degradation of adjacent wetlands and streams, except as authorized by this permit, the permittee shall require its contractors and/or agents to identify all areas to be used to borrow material, or to dispose of dredged, fill, or waste material. The permittee shall provide the USACE with appropriate maps indicating the locations of proposed borrow or waste sites as soon as the permittee has that information. The permittee will coordinate with the USACE before approving any borrow or waste sites that are within 400 feet of any streams or wetlands. All jurisdictional wetland lines on borrow and waste sites shall be verified by the Corps of Engineers and shown on the approved reclamation plans. The permittee shall ensure that all such areas comply with Condition b) of this permit, and shall require and maintain documentation of the location and characteristics of all borrow and disposal sites associated with this project. This information will include data regarding soils, vegetation and hydrology sufficient to clearly demonstrate compliance with the Condition b). All information will be available to the USACE upon request. NCDOT shall require its contractors to complete and execute reclamation plans for each waste and borrow site and provide written documentation that the reclamation plans have been implemented and all work is completed. This documentation will be provided to the Corps of Engineers within 30 days of the completion of the reclamation work.

MITIGATION

o. The permittee shall mitigate for 2.29 acres of wetland impacts, and 4,455 linear feet of impact to streams with important aquatic function, for this project, as described below (1.05 acres of riverine bottomland hardwood wetland restoration at the Yadkin River Swamp Hardwoods Restoration Mitigation Site, and 2.48 acres of restoration equivalent

non-riverine wetlands, and 8,910 linear feet of restoration equivalent warm water stream channel, through the North Carolina Ecosystem Enhancement Program (EEP), in the Yadkin River basin (Cataloging Unit 03040103).

YADKIN RIVER SWAMP HARDWOODS RESTORATION MITIGATION SITE

p. The permittee shall implement the compensatory wetland mitigation plan entitled "Restoration Plan for Swamp Hardwoods Wetlands At Existing Bridge Causeway of the I-85 Yadkin River In Rowan County", dated July 12, 2004, to provide the restoration described in condition n. below. NCDOT shall complete grading for the mitigation within one year of demolition of the existing I-85 Yadkin River bridge, and complete planting of the site within the first planting season (November 15 to March 15) after grading is completed. NCDOT shall contact the Corps of Engineers, Raleigh Regulatory Field Office NCDOT Regulatory Project Manager, a minimum of sixty days before completion of grading at the mitigation site, and inform the Project Manager of the expected completion date of the grading.

q. The permittee shall mitigate for 1.05 acres of unavoidable impacts to riverine bottomland hardwood forest wetlands associated with this project with 1.05 acres of riverine bottomland hardwood forest wetland restoration, at the Yadkin River Swamp Hardwoods Restoration Mitigation Site (Yadkin Site).

r. NCDOT will do a boundary survey of the 1.05 acres of wetland restoration at the Yadkin Site, and submit a copy of the survey to the District Engineer within 90 days after construction of the site is completed.

s. The permittee will monitor the site vegetation between June 1 and November 30, inclusively, of each year, and document plant mortality and stress. A minimum of one 0.05-acre sample plots will be established within the 1.05 acre restoration area, and will be placed randomly within a representative position. The permittee will continue monitoring of the planting area annually until the specified performance criteria is met, as described below.

YADKIN SITE MITIGATION MONITORING

t. Performance criteria for tree planting areas will be met if sample plots demonstrate that for each of the first three complete years of monitoring, 320 target-species trees per acre have survived, such that at the end of three years, 320 three-year old target-species trees per acre have survived on the site, and, in years four and five, 288 and 260 trees per acre, respectively, have survived on the site, such that at the end of year five, 260 five-year old target-species trees per acre have survived on the site.

u. If for any monitoring year, vegetation survival is not favorable, as determined by the Corps of Engineers, any remedial action required by the Corps of Engineers will be performed, the required restoration areas will be replanted, and the five-year monitoring period will begin again with year one.

GENERAL WETLANDS MITIGATION

v. The permittee and subsequent property owners shall maintain the Yadkin Site in its natural condition, as altered by work in the mitigation plan, in perpetuity. Prohibited activities within the mitigation site specifically include, but are not limited to: the construction or placement of roads, walkways, buildings, signs, or structures of any kind (i.e., billboards, interior fences, etc.); filling, grading, excavation, leveling, or any other earth moving activity or activity that may alter the drainage patterns on the property; the cutting, mowing, destruction, removal, or other damage of any vegetation; disposal or storage of any debris, trash, garbage, or other waste material; except as may be authorized by the mitigation plans, or subsequent modifications that are approved by the Corps of Engineers. In addition, the permittee shall take no action, whether on or off the mitigation property, which will adversely impact the wetlands on the mitigation property, except as specifically authorized by this permit, or subsequent modifications that are approved by the Corps of Engineers.

w. The permittee shall make every effort to convey the Yadkin Site property to a nonprofit conservation organization or a natural resource agency, which is willing to hold the areas in perpetuity for conservation purposes, and which is acceptable to the Corps of Engineers. The annual monitoring reports, as required, will include the status of the conveyance efforts.

x. The permittee shall not sell or otherwise convey any interest in the property used to satisfy mitigation requirements for this permit, to any third party, without 10 days prior notification to Wilmington District Corps of Engineers in writing, which writing shall reference this permit Action ID number.

y. Any sale, lease, or other conveyance of the mitigation site property shall include restrictions on the use of the property as described in condition x. above, which conditions shall be enforced by the North Carolina Department of Transportation. Such restrictions shall include language providing for third party enforcement rights in favor of the Corps of Engineers. Such restrictions must be approved prior to conveyance by the Corps of Engineers.

GENERAL MITIGATION

z. The permittee shall contact the Corps of Engineers, Raleigh Regulatory Field Office NCDOT Regulatory Project Manager, to provide that individual with the opportunity to attend the yearly mitigation monitoring efforts.

NC-EEP STREAM AND WETLAND MITIGATION:

aa. Compensatory mitigation for the unavoidable impacts to 1.24 acres of non-riverine wetlands, and 4,455 linear feet of stream associated with the proposed project shall be provided by the Ecosystem Enhancement Program (EEP), as outlined in the letter dated April 30, 2004 from William D. Gilmore, EEP Transition Manager. Pursuant to the EEP

Memorandum of Agreement (MOA) between the State of North Carolina and the US Army Corps of Engineers signed on July 22, 2003, the EEP will provide 2.48 acres of restoration equivalent non-riverine wetlands, and 8,910 linear feet of restoration equivalent warm water stream channel in the Yadkin River basin (Cataloging Unit 03040103) by one year of the date of this permit. For wetlands, a minimum of 1:1 (impact to mitigation) must be in the form of wetland restoration. The NCDOT shall, within 30 days of the issue date of this permit, certify that sufficient funds have been provided to EEP to complete the required mitigation, pursuant to Paragraph V. of the MOA.

Navigation

bb. The authorized fill and structures, and associated activities, in the Yadkin River must not interfere with the public's right to free navigation on the river. No attempt will be made by the permittee to prevent the full and free use by the public of the river at or adjacent to the authorized work for reason other than safety. NCDOT shall not modify the design of the temporary work bridges to provide an unobstructed main channel less than fifty feet wide, with no vertical structural obstructions from the work bridges extending into the opening.

Historic Property

cc. NCDOT shall leave Bridge No. 46, which currently carries US 29-70 over the Yadkin River in the southbound direction, in place, due to its historical significance. NCDOT shall close the bridge to vehicular traffic, but it will serve pedestrian and bicycle traffic. NCDOT shall work out ownership and maintenance responsibilities with the Rowan and Davidson County Commissioners, the Transportation Museum, and the North Carolina State Historic Preservation Office.

NORTH CAROLINA

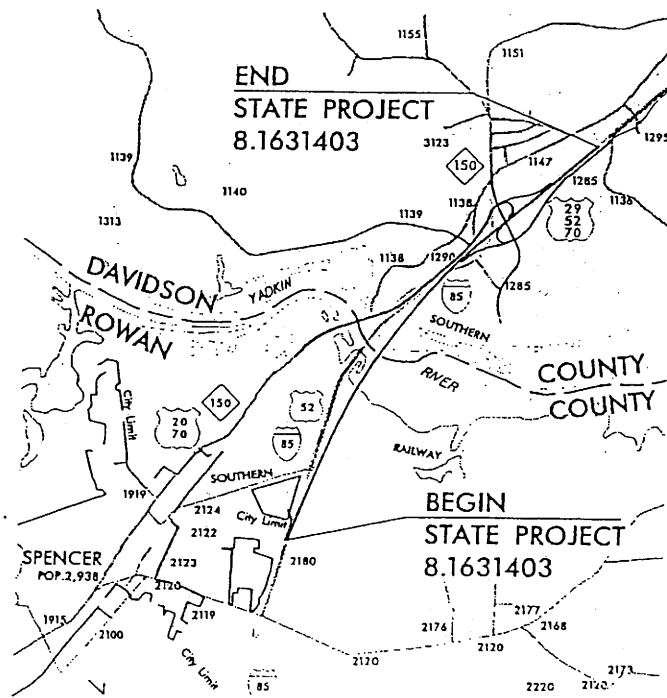
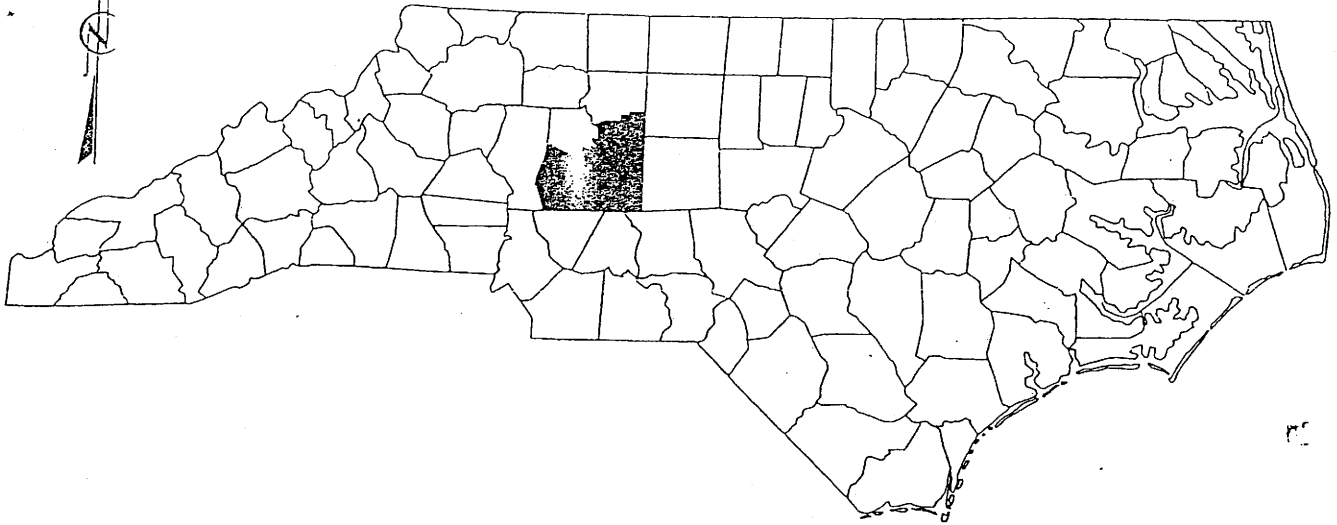

VICINITY MAPS

NCDOT

DIVISION OF HIGHWAYS
DAVIDSON / ROWAN

PROJECT: 8.1631403 (I-2304AA)

I-85 FROM NORTH OF SR 2120 IN
ROWAN COUNTY TO NORTH OF
NC 150 IN DAVIDSON COUNTY

SHEET 1 OF 21

5/7/05

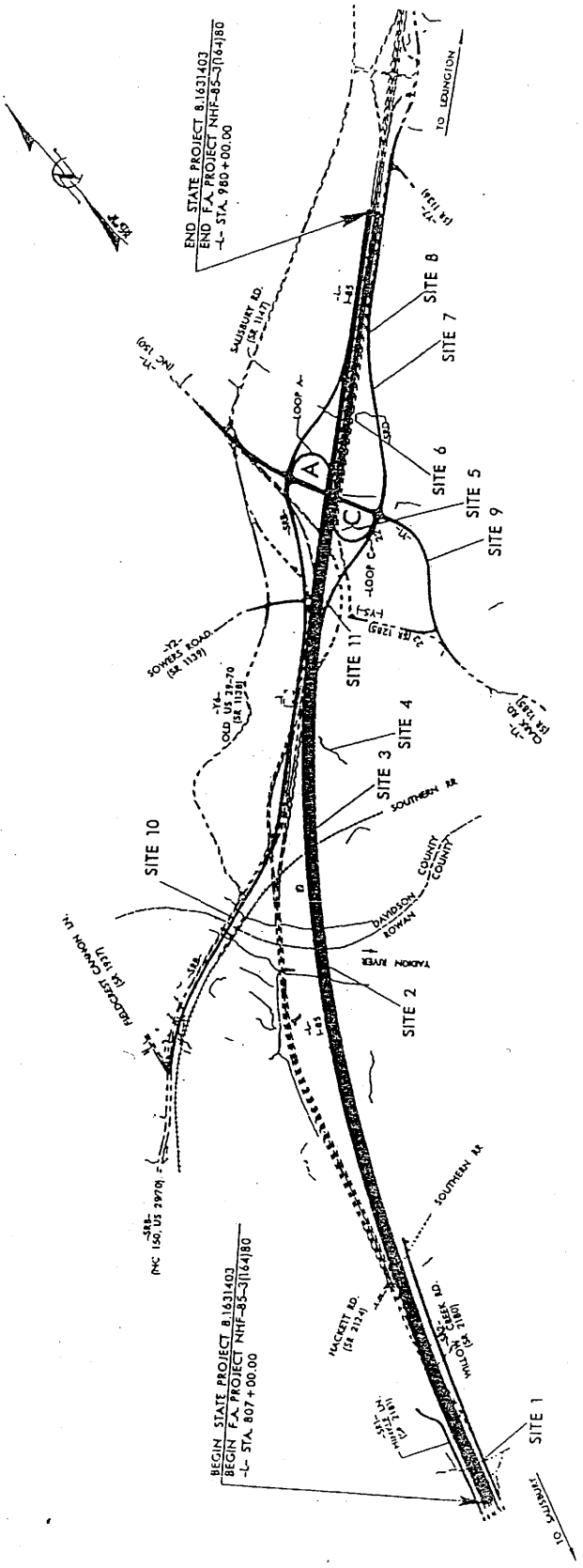

NCDOT

DIVISION OF HIGHWAYS
DAVIDSON/ROWAN

PROJECT: 8.1631403 (I-2304AA)

I-85 FROM NORTH OF SR 2120 IN
ROWAN COUNTY TO NORTH OF
NC 150 IN DAVIDSON COUNTY

SHEET 2 OF 21 5/8/03



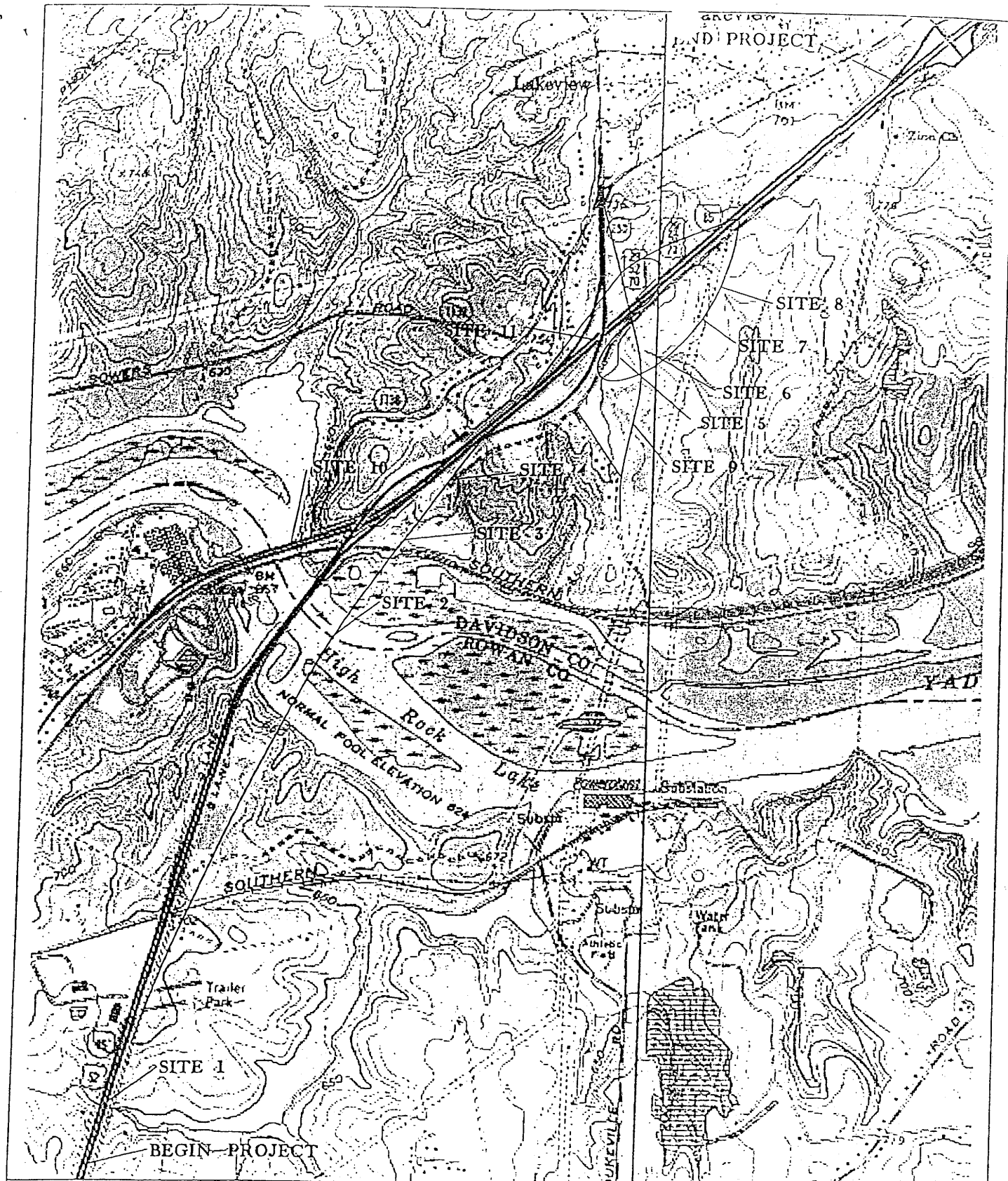







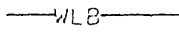
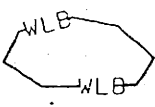
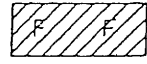

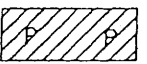

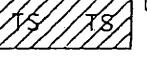

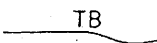
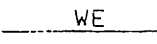
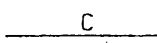
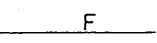
SITE MAP

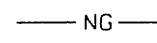
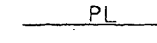
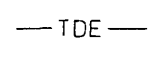
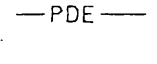
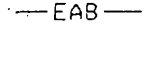
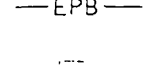
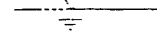
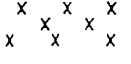

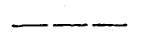
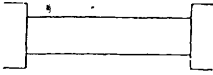
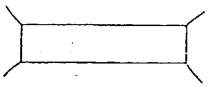
TOPO MAP
SCALE 1" = 2000'

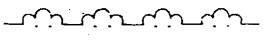
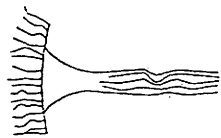
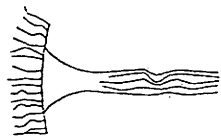
NCDOT
 DIVISION OF HIGHWAYS
 DAVIDSON/ROWAN COUNTY
 PROJECT: 8.1631403 (I-2304AA)
 I-85 FROM NORTH OF SR 2120 IN
 ROWAN COUNTY TO NORTH OF
 NC 150 IN DAVIDSON COUNTY
 SHEET **3** OF **21**

WETLAND LEGEND

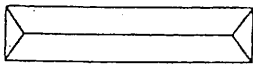
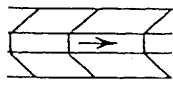
-  WETLAND BOUNDARY
-  WETLAND
-  DENOTES FILL IN WETLAND
-  DENOTES FILL IN SURFACE WATER
-  DENOTES FILL IN SURFACE WATER (POND)
-  DENOTES TEMPORARY FILL IN WETLAND
-  DENOTES EXCAVATION IN WETLAND
-  DENOTES TEMPORARY FILL IN SURFACE WATER
-  DENOTES MECHANIZED CLEARING
-  FLOW DIRECTION
-  TOP OF BANK
-  EDGE OF WATER
-  PROP. LIMIT OF CUT
-  PROP. LIMIT OF FILL
-  PROP. RIGHT OF WAY
-  NATURAL GROUND
-  PROPERTY LINE
-  TEMP. DRAINAGE EASEMENT
-  PERMANENT DRAINAGE EASEMENT
-  EXIST. ENDANGERED ANIMAL BOUNDARY
-  EXIST. ENDANGERED PLANT BOUNDARY
-  WATER SURFACE
-  LIVE STAKES
-  BOULDER
-  CORE FIBER ROLLS
-  PROPOSED BRIDGE
-  PROPOSED BOX CULVERT
-  PROPOSED PIPE CULVERT
12"-48"
PIPES
54" PIPES
& ABOVE
(DASHED LINES DENOTE EXISTING STRUCTURES)
-  SINGLE TREE
-  WOODS LINE
-  DRAINAGE INLET
-  ROOTWAD
-  RIP RAP
-  ADJACENT PROPERTY OWNER OR PARCEL NUMBER IF AVAILABLE
-  PREFORMED SCOUR HOLE
-  LEVEL SPREADER (LS)
-  DITCH / GRASS SWALE

NCDOT
 DIVISION OF HIGHWAYS
 DAVIDSON/ROWAN COUNTY
 PROJECT: 8.1631403 (I-2304AA)
 I-85 FROM NORTH OF SR 2120 IN
 ROWAN COUNTY TO NORTH OF
 NC 150 IN DAVIDSON COUNTY

SHEET **4** OF **21**

5/7/03

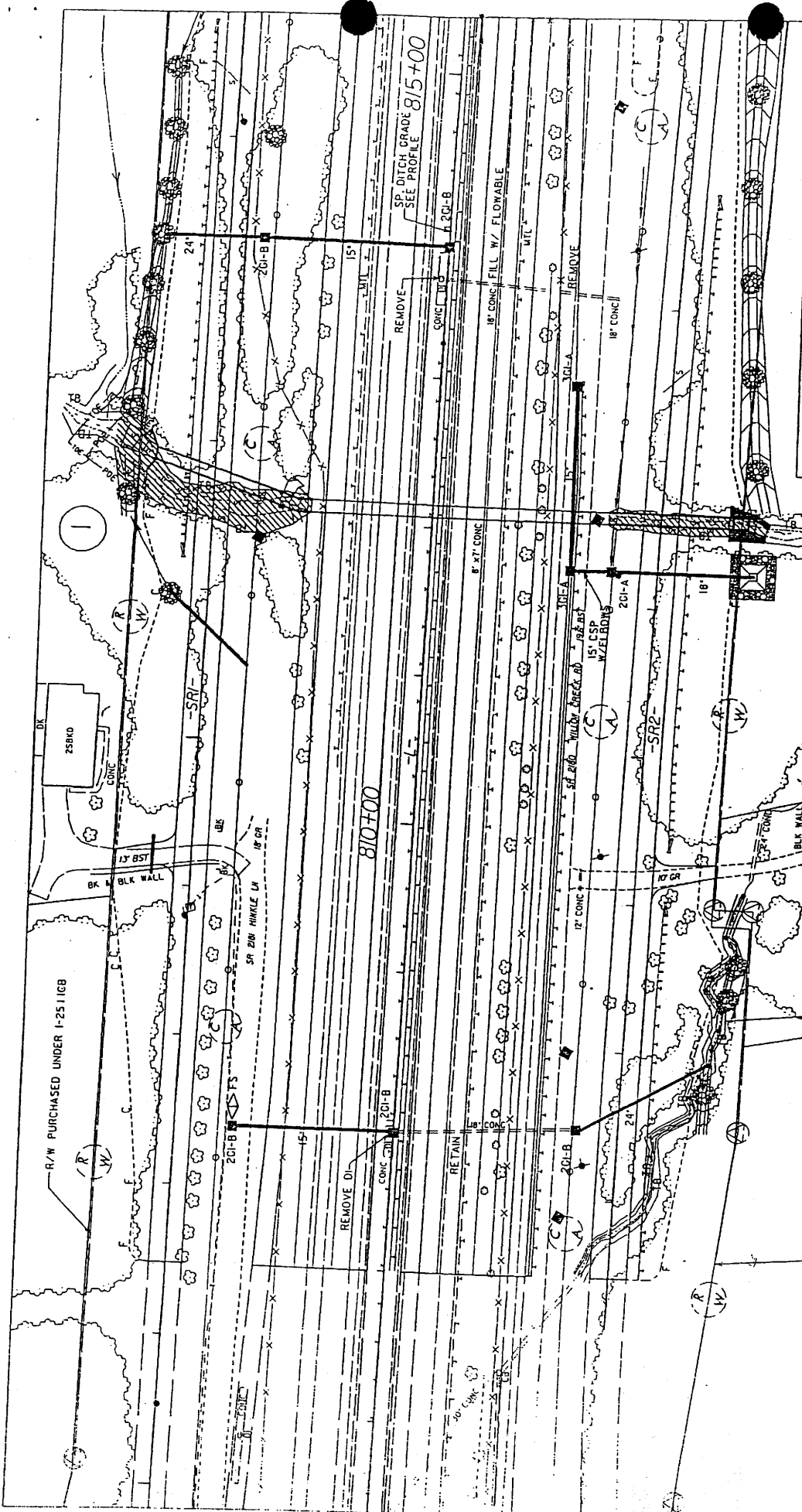

NCDOT
 DIVISION OF HIGHWAYS
 DAVIDSON/ROWAN
 PROJECT: 81651403 (I-2304.A.A)
 I-85 FROM NORTH OF SR 2120 IN
 ROWAN COUNTY TO NORTH OF
 NC 150 IN DAVIDSON COUNTY

PLAN VIEW
 STREAM
 IMPACTS
 SITE I

TO BE PERMITTED
 UNDER I-25 I/CB

SCALE 1" = 100'

SHEET 5 OF 21

6/25/03

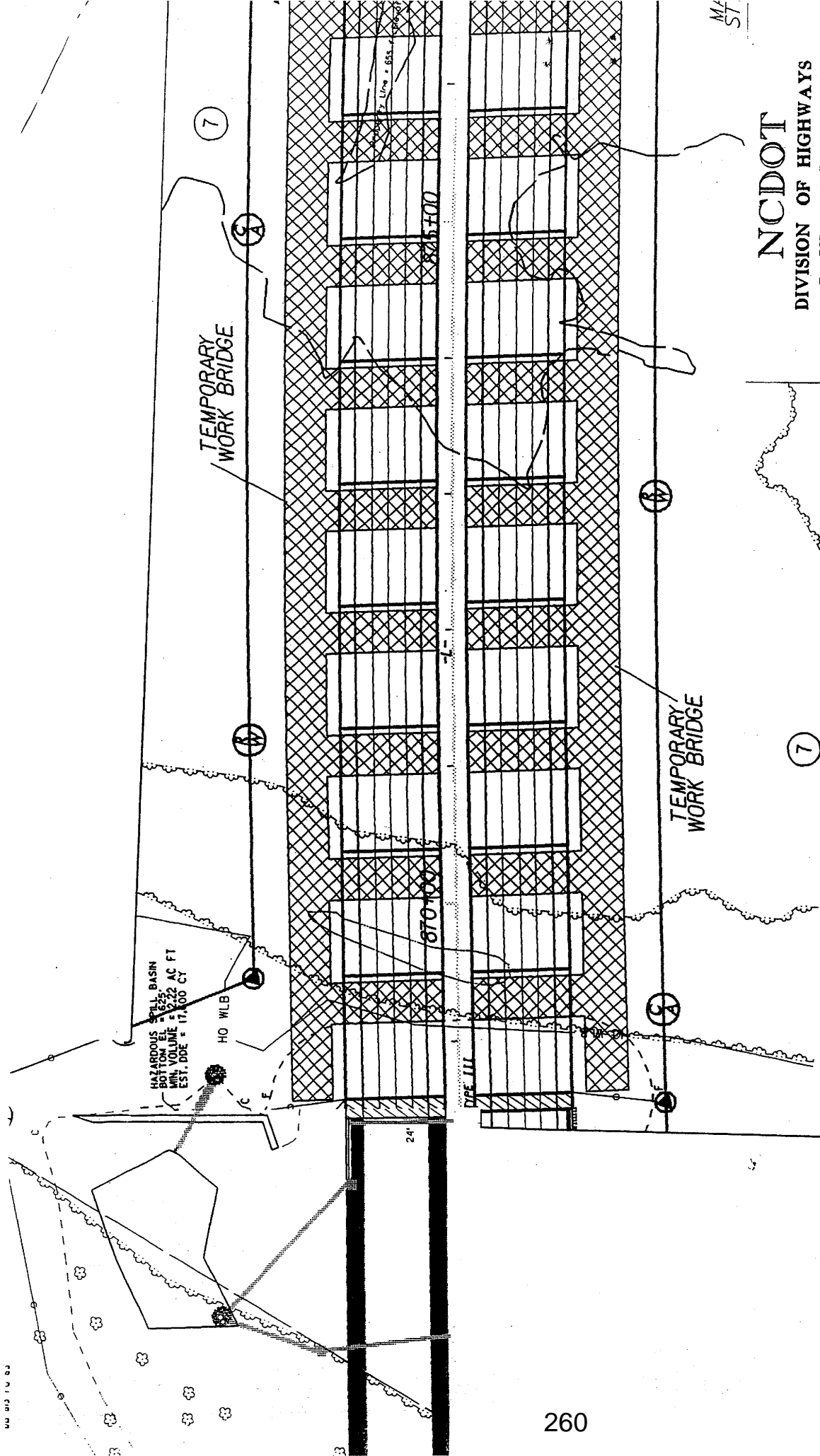

NCDOT
 DIVISION OF HIGHWAYS
 DAVIDSON/ROWAN

PROJECT: 8.1651403 (I-2304AA)

I-85 FROM NORTH OF SR 2120 IN
 ROWAN COUNTY TO NORTH OF
 NC 150 IN DAVIDSON COUNTY

Rev: 10/04

SHEET 6 OF 21

3/2/04

SCALE 1" = 100'

PLAN VIEW
 STREAM
 IMPACTS
 SITE 2

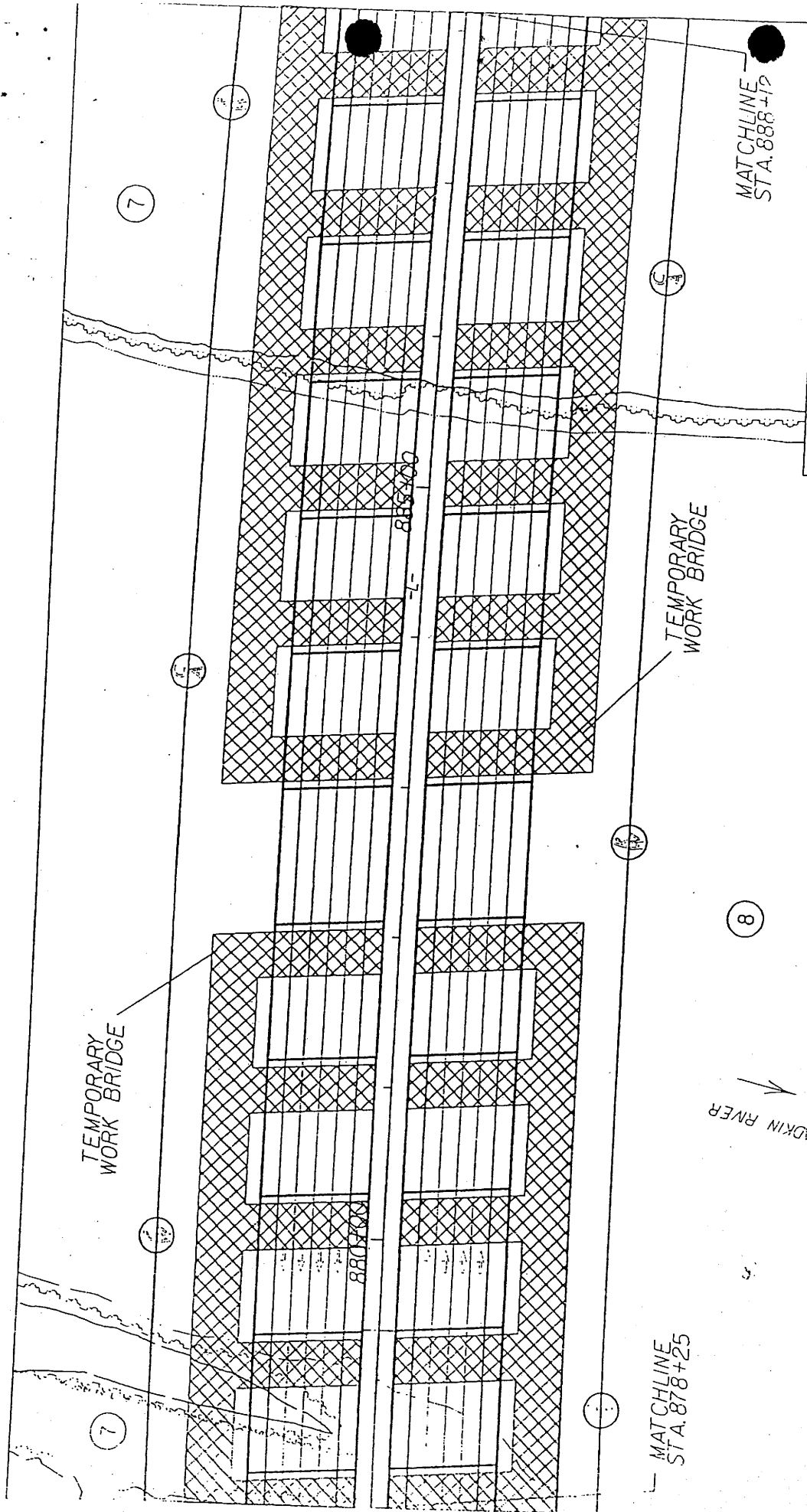

NCDOT
 DIVISION OF HIGHWAYS
 DAVIDSON/ROWAN
 PROJECT: 8.1631403 (I-2304.AA)
 I-85 FROM NORTH OF SR 2120 IN
 ROWAN COUNTY TO NORTH OF
 NC 150 IN DAVIDSON COUNTY

PLAN VIEW
 STREAM
 IMPACTS
 SITE 2

SCALE 1" = 100'

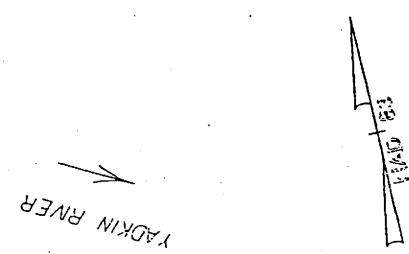

SHEET 7 OF 21
 8/30/02

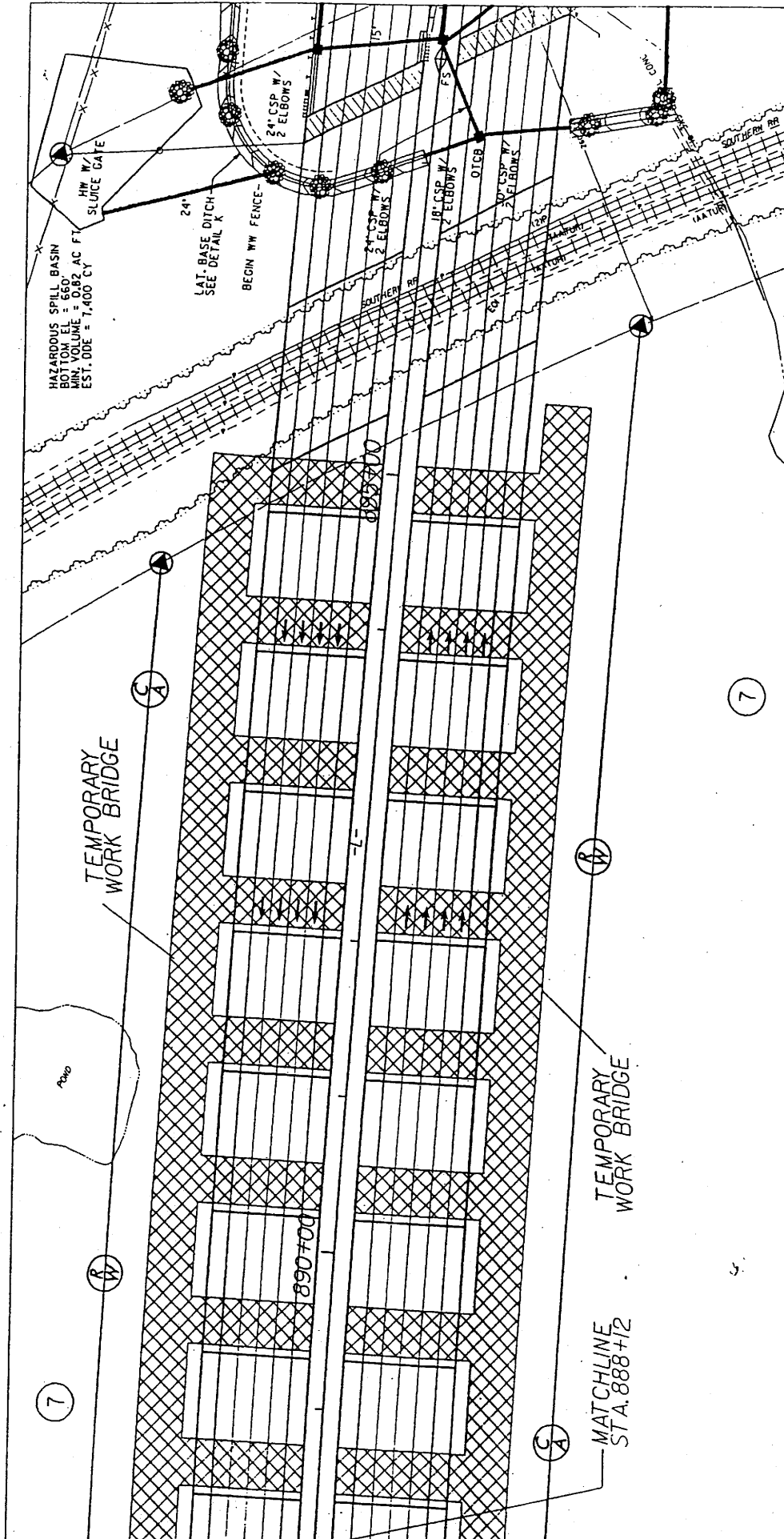

NCDOT
 DIVISION OF HIGHWAYS
 DAVIDSON/ROWAN
 PROJECT: 8.1631403 (I-2304AA)
 I-85 FROM NORTH OF SR 2120 IN
 ROWAN COUNTY TO NORTH OF
 NC 150 IN DAVIDSON COUNTY
 Rev: 10/04
 SHEET 8 OF 21 3/2/04

PLAN VIEW
 STREAM
 IMPACTS
 SITE 2
 SCALE 1" = 100'
 NAD '83

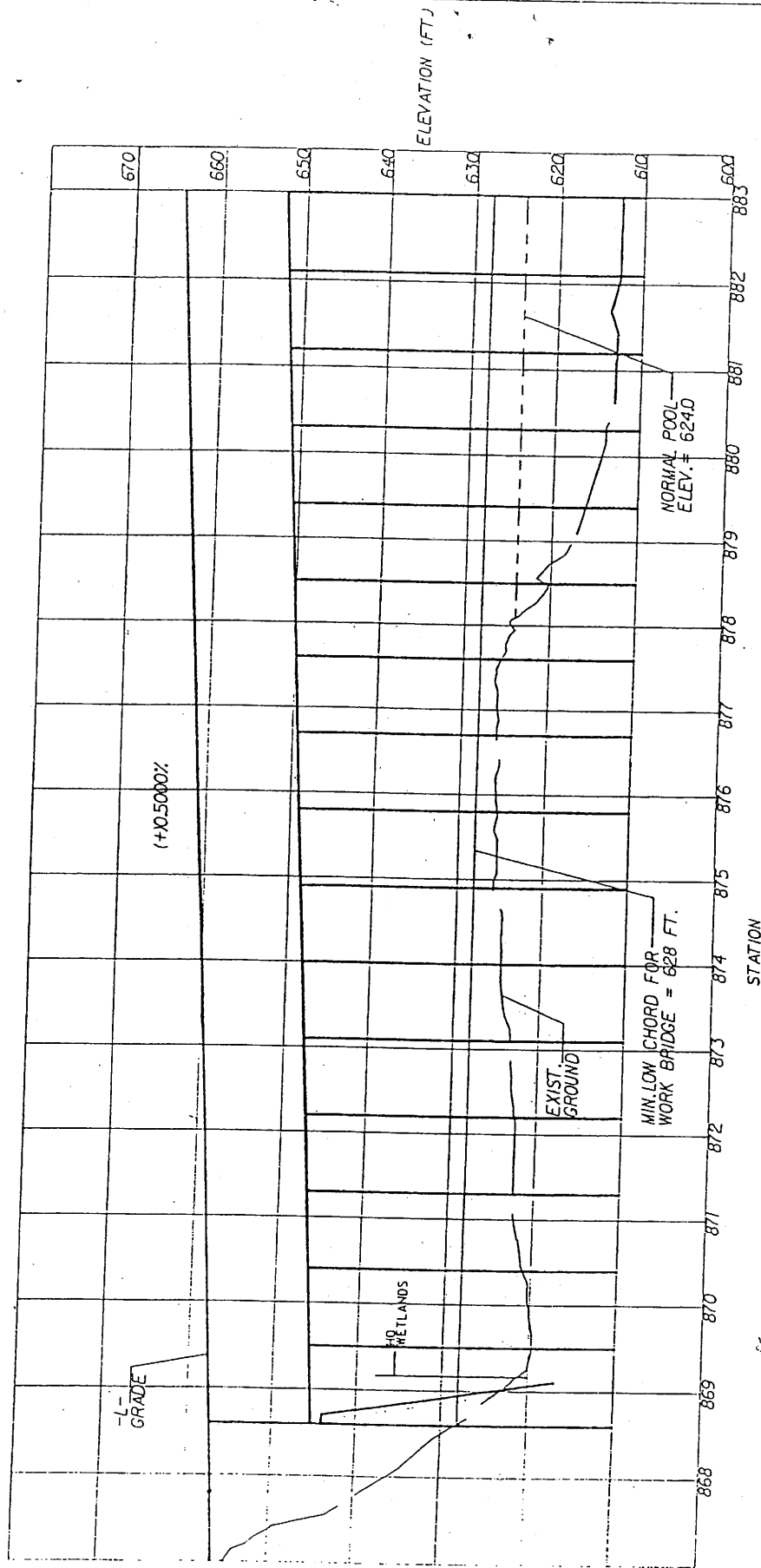

NCDOT
 DIVISION OF HIGHWAYS
 DAVIDSON/ROWAN
 PROJECT: 8.1631403 (I-2304.A.A.)
 I-85 FROM NORTH OF SR 2120 IN
 ROWAN COUNTY TO NORTH OF
 NC 150 IN DAVIDSON COUNTY

PROFILE VIEW
 SITE 2

SCALE 1" = 200' HORIZONTAL
 1" = 20' VERTICAL

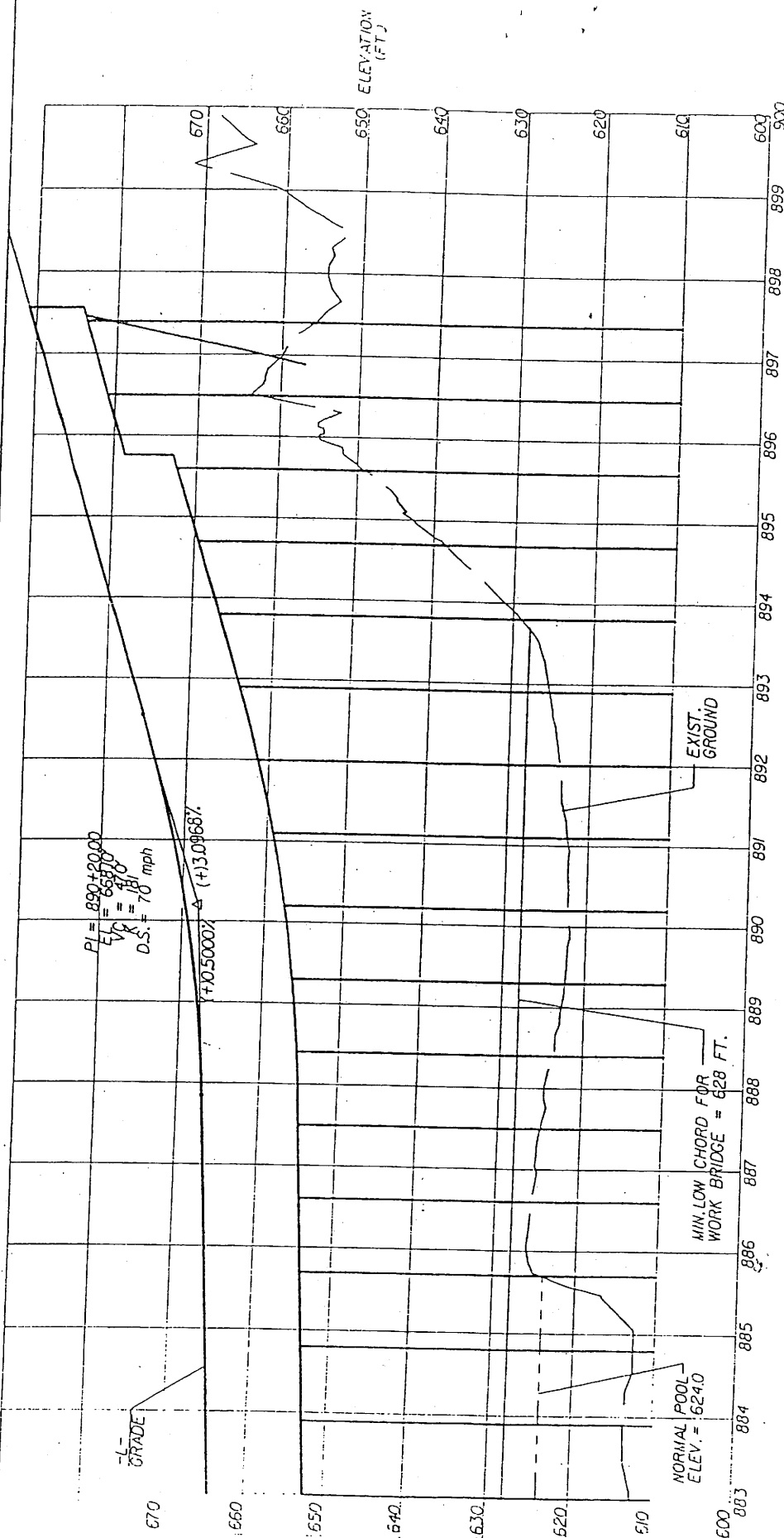

PROFILE VIEW
SITE 2

SCALE 1" = 200' HORIZONTAL
1" = 20' VERTICAL

NCDOT
DIVISION OF HIGHWAYS
DAVIDSON/ROWAN
PROJECT: 8.1631-403 (I-2304.A.A)

I-85 FROM NORTH OF SR 2120 IN
ROWAN COUNTY TO NORTH OF
NC 150 IN DAVIDSON COUNTY

SHEET 10 OF 21

5/7/03

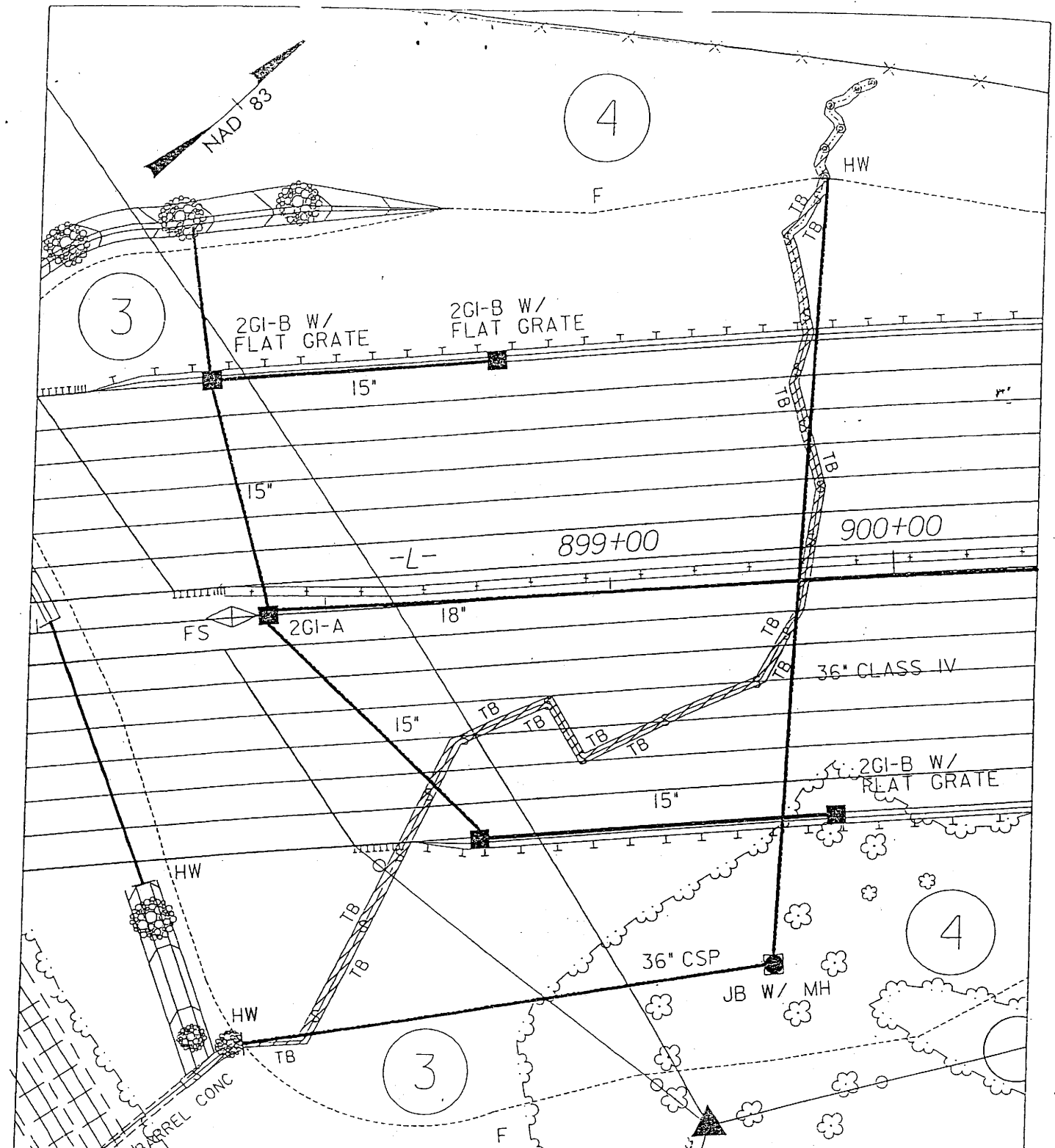

PLAN VIEW
 STREAM
 IMPACTS
 SITE 5
 SCALE 1" = 50'

NCDOT
 DIVISION OF HIGHWAYS
 DAVIDSON/ROWAN
 PROJECT: 8.1631405 (I-2504AA)
 I-85 FROM NORTH OF SR 2120 IN
 ROWAN COUNTY TO NORTH OF
 NC 150 IN DAVIDSON COUNTY

SHEET 11 OF 21

6/25/03

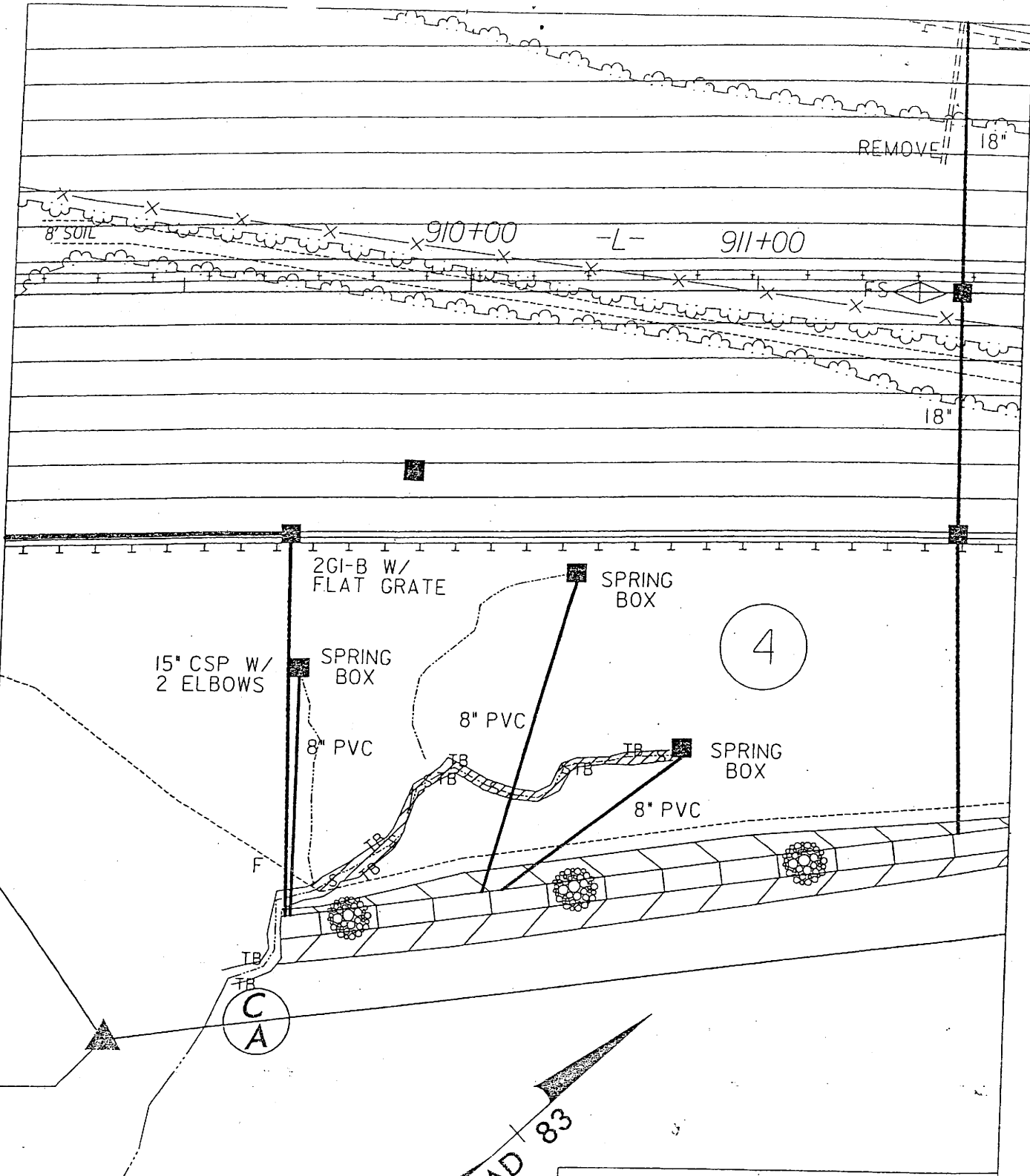

PLAN VIEW
 SITE 4
 STREAM
 IMPACTS
 SCALE 1" = 50'

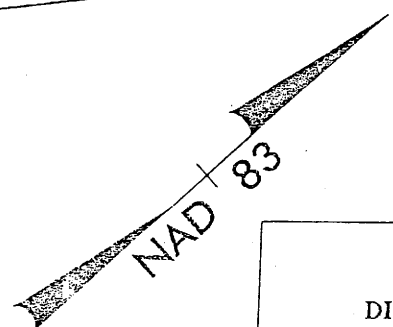

NCDOT
 DIVISION OF HIGHWAYS
 DAVIDSON/ROWAN COUNTY
 PROJECT: 8.1651403 (I-2304AA)
 I-85 FROM NORTH OF SR 2120 IN
 ROWAN COUNTY TO NORTH OF
 NC 150 IN DAVIDSON COUNTY

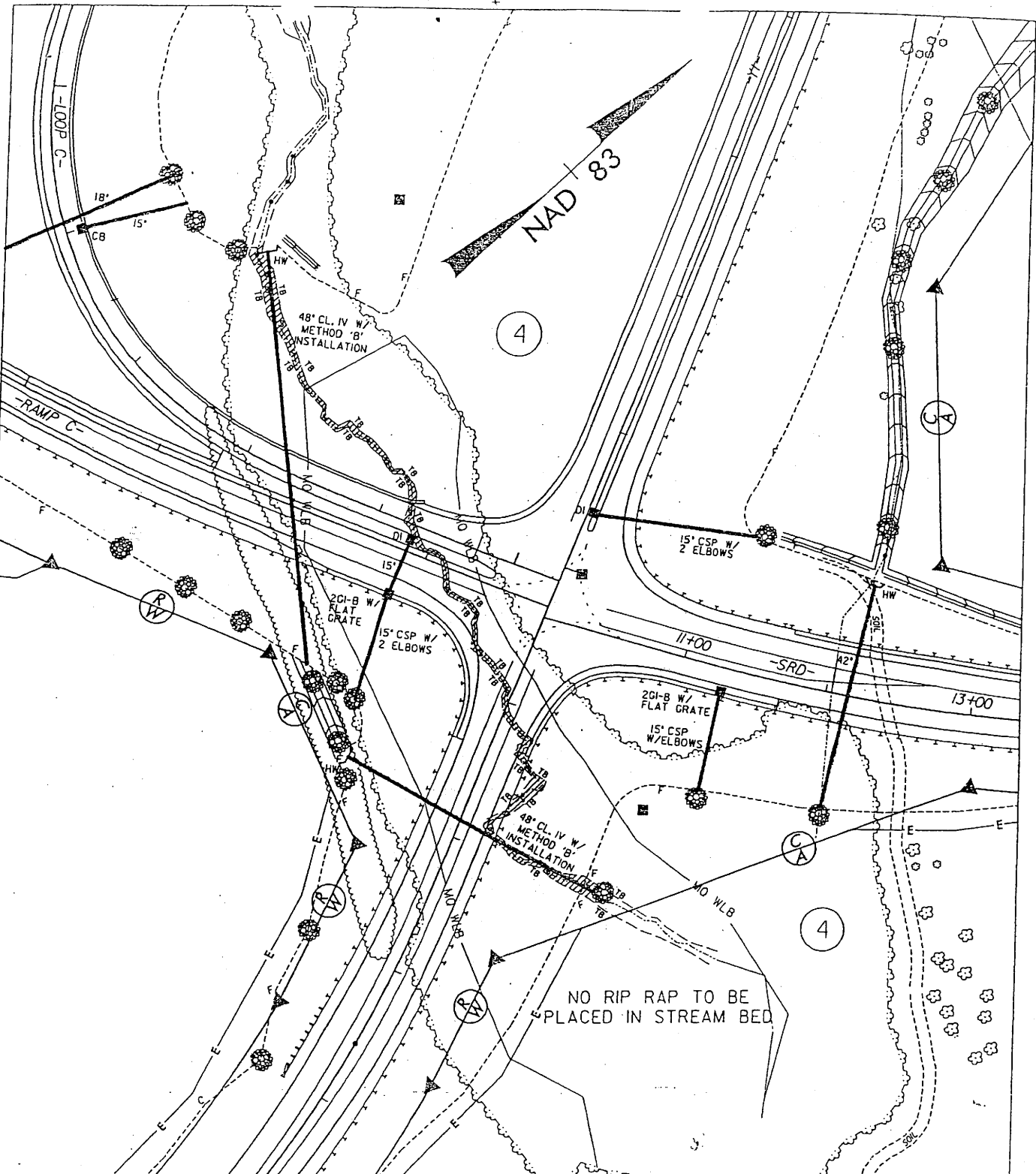

PLAN VIEW
 STREAM
 IMPACTS
 SITE 5
 SCALE 1" = 100'

NCDOT
 DIVISION OF HIGHWAYS
 DAVIDSON/ROWAN COUNTY
 PROJECT: 8.1631403 (I-2504AA)
 I-85 FROM NORTH OF SR 2120 IN
 ROWAN COUNTY TO NORTH OF
 NC 150 IN DAVIDSON COUNTY

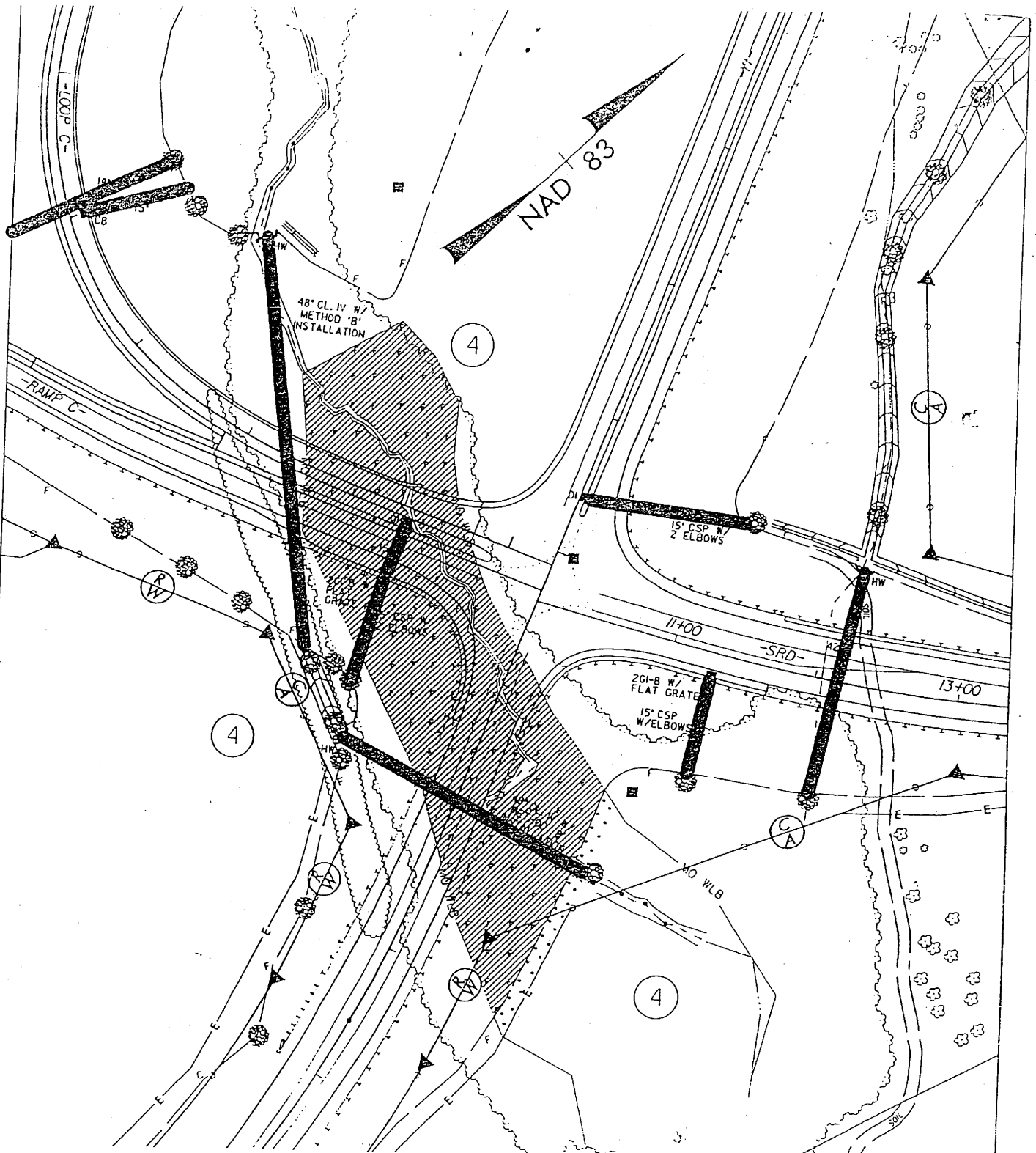

PLAN VIEW
 WETLAND
 IMPACTS
 SITE 5
 SCALE 1" = 100'

NCDOT
 DIVISION OF HIGHWAYS
 DAVIDSON/ROWAN COUNTY
 PROJECT: 8.1631403 (I-2304AA)
 I-85 FROM NORTH OF SR 2120 IN
 ROWAN COUNTY TO NORTH OF
 NC 150 IN DAVIDSON COUNTY

SHEET 14 OF 21

5/7/03

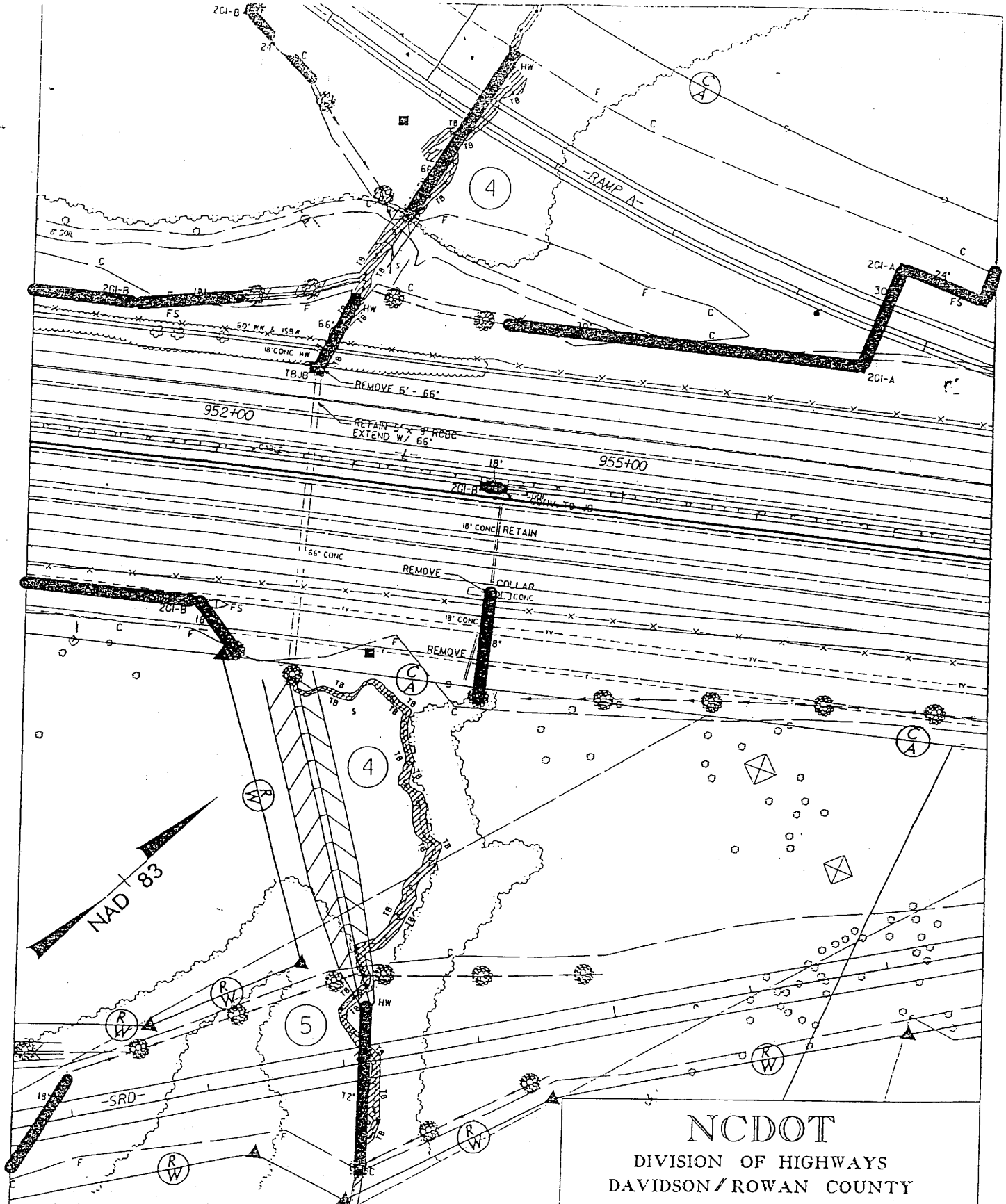

PLAN VIEW
 STREAM
 IMPACTS
 SITE 6

SCALE
 1" = 100'

NCDOT
 DIVISION OF HIGHWAYS
 DAVIDSON/ROWAN COUNTY
 PROJECT: 8.1631403 (I-2304AA)
 I-85 FROM NORTH OF SR 2120 IN
 ROWAN COUNTY TO NORTH OF
 NC 150 IN DAVIDSON COUNTY
 SHEET 15 OF 21

5/7/05

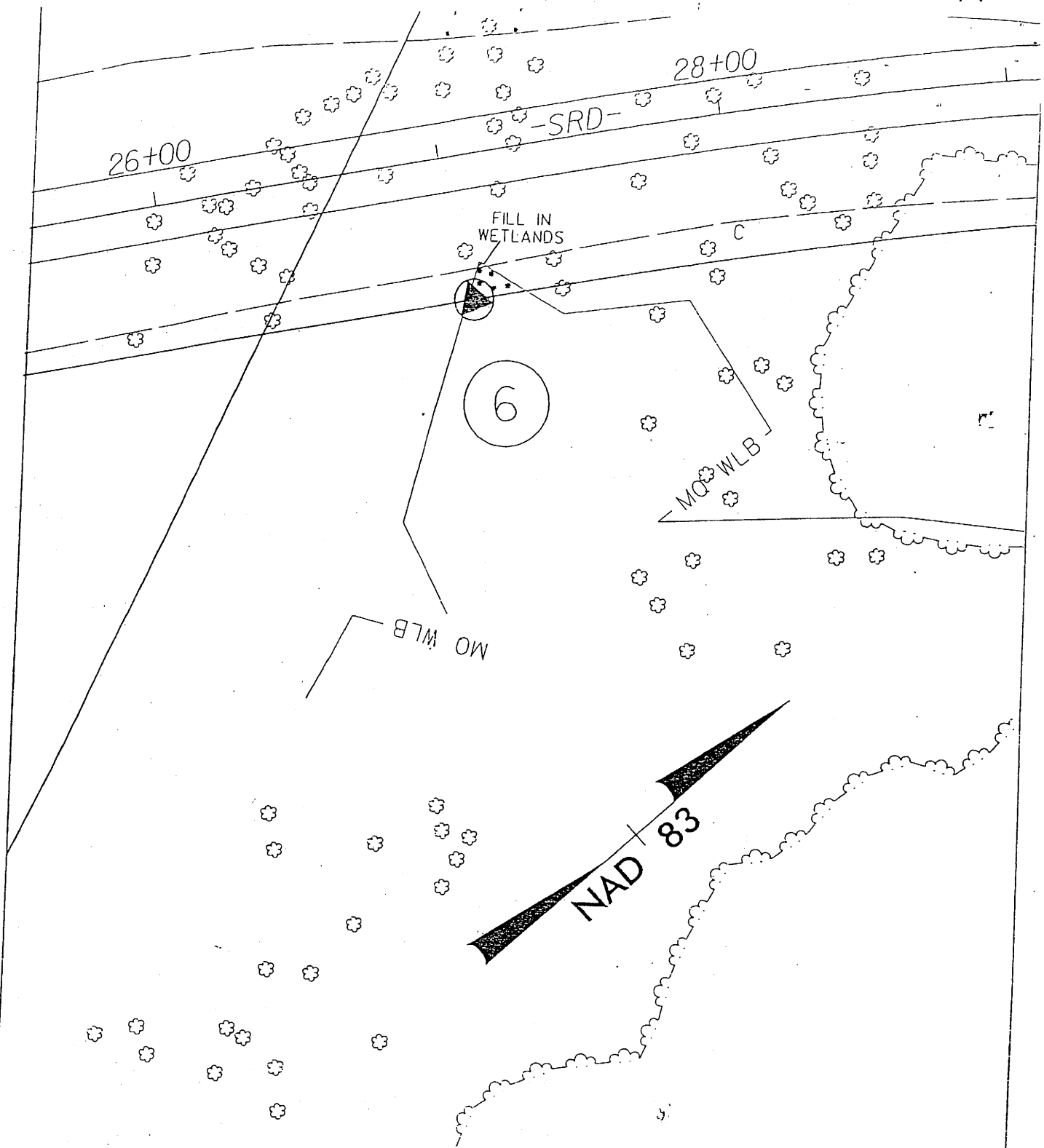

PLAN VIEW
 WETLAND
 IMPACTS
 SITE 7
 SCALE 1" = 50'

NCDOT
 DIVISION OF HIGHWAYS
 DAVIDSON/ROWAN COUNTY
 PROJECT: 8.1631405 (I-2504AA)
 I-85 FROM NORTH OF SR 2120 IN
 ROWAN COUNTY TO NORTH OF
 NC 150 IN DAVIDSON COUNTY

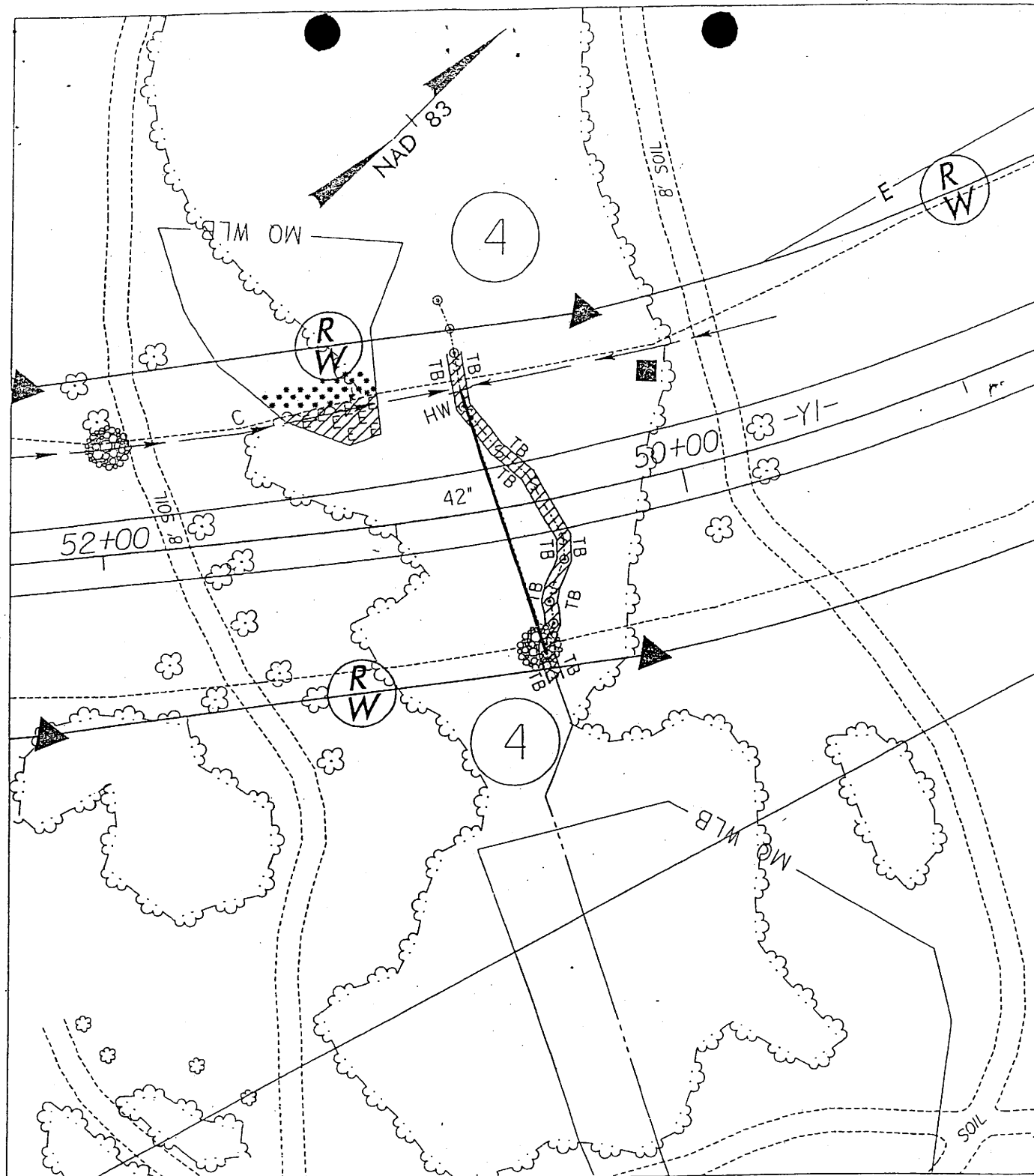

PLAN VIEW
 STREAM & WETLAND
 IMPACTS
 SITE 9
 SCALE 1" = 50'

NCDOT
 DIVISION OF HIGHWAYS
 DAVIDSON/ROWAN
 PROJECT: 8.1651405 (I-2504AA)
 I-85 FROM NORTH OF SR 2120 IN
 ROWAN COUNTY TO NORTH OF
 NC 150 IN DAVIDSON COUNTY
 SHEET 17 OF 21
 6/25/05

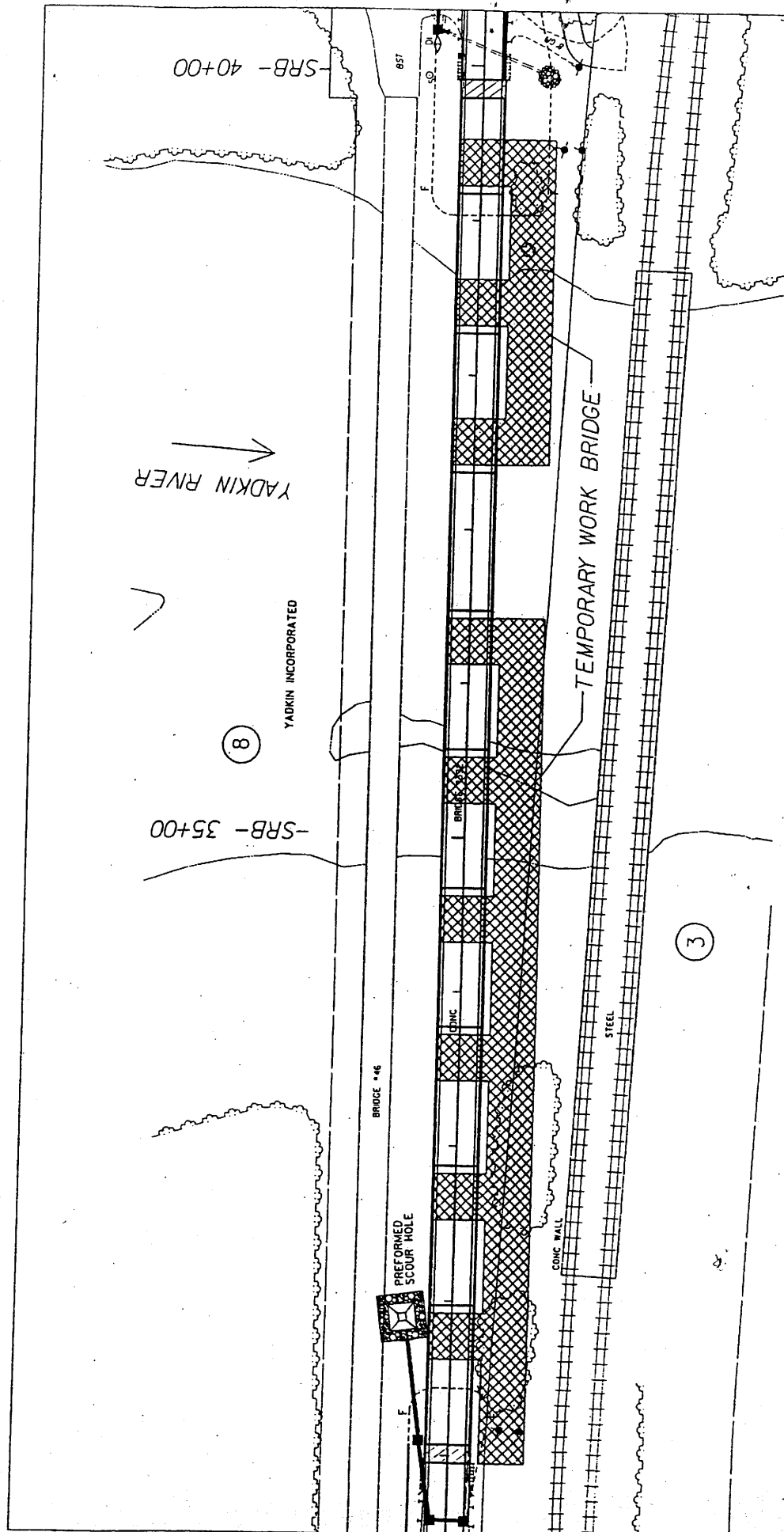

NCDOT
 DIVISION OF HIGHWAYS
 DAVIDSON/ROWAN
 PROJECT: 8.1631403 (I-2304.AA)
 I-85 FROM NORTH OF SR 2120 IN
 ROWAN COUNTY TO NORTH OF
 NC 150 IN DAVIDSON COUNTY
 Rev: 10/04
 SHEET 18 OF 21
 3/2/04

PLAN VIEW
 STREAM
 IMPACTS
 SITE 10
 SCALE 1" = 100'

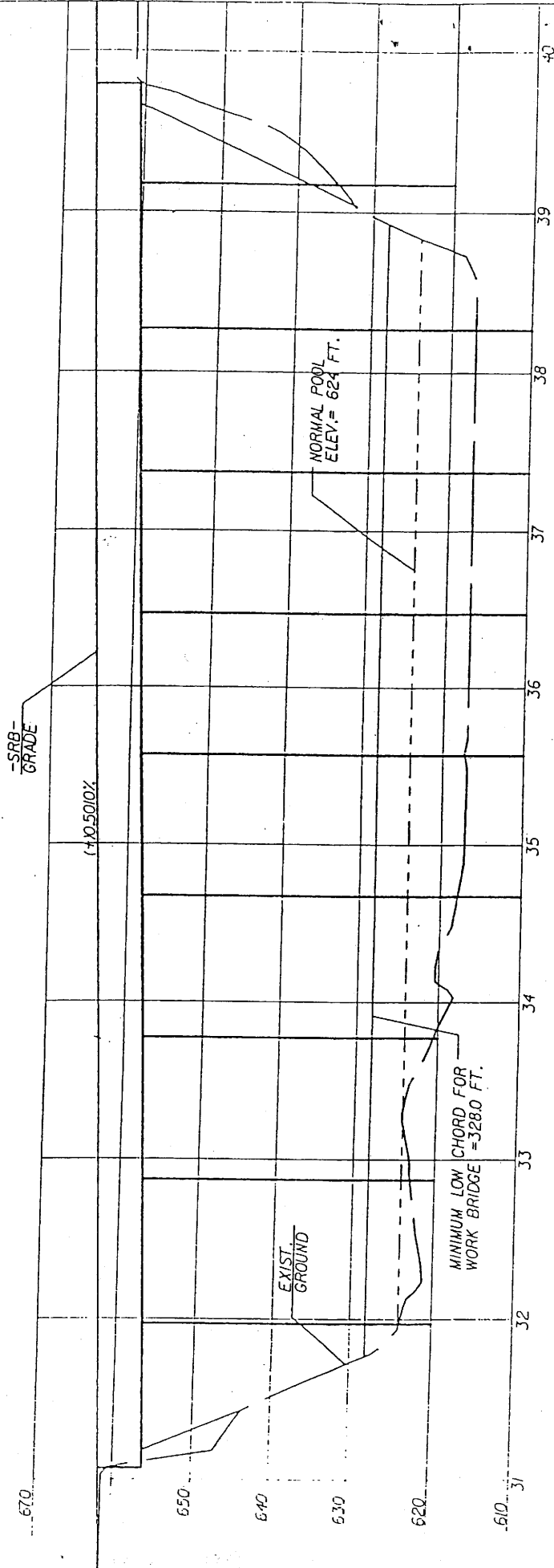

PROFILE VIEW
SITE 10

SCALE 1" = 100' HORIZONTAL
1" = 20' VERTICAL

NCDOT

DIVISION OF HIGHWAYS
DAVIDSON/ROWAN

PROJECT: 81631403 (I-2304.A.A)

I-85 FROM NORTH OF SR 2120 IN
ROWAN COUNTY TO NORTH OF
NC 150 IN DAVIDSON COUNTY

SHEET 19 OF 21

5/7/05

PROPERTY OWNERS

NAMES AND ADDRESSES

PARCEL NO.	NAMES	ADDRESSES
1	HINKLE, PAUL P.	455 HINKLE LANE SALISBURY, NC 28144-8555
2	HINKLE, JR., HOLLIS L.	655 HACKETT ST. SALISBURY, NC 28144-7769
3	SOUTHERN RAIL CO.	8 NORTH JEFFERSON ST. ROANOKE, VA 24042
4	GRUBB, ROBERT L.	P.O. BOX 388 HIGH POINT, NC 27260
5	DUKE POWER COMPANY	P.O. BOX 1090 CHARLOTTE, NC 28201-1090
6	FALCON DEVELOPMENT GROUP INC.	1329 SOUTH MAIN ST. SALISBURY, NC 28144
7	ALUMINUM COMPANY OF AMERICA	P.O. BOX 688 BADIN, NC 28009
8	YADKIN INCORPORATED	P.O. BOX 688 BADIN, NC 28009

NCDOT

DIVISION OF HIGHWAYS
DAVIDSON/ROWAN COUNTY
PROJECT: 8.1631403 (I-2304AA)

I-85 FROM NORTH OF SR 2120 IN
ROWAN COUNTY TO NORTH OF
NC 150 IN DAVIDSON COUNTY

WETLANDS IMPACT PERMIT SUMMARY

Site No.	Station (From/To)	Structure Size / Type	Fill In Wetlands (ac)	Temp. Fill In Wetlands (ac)	Excavation In Wetlands (ac)	Mechanized Clearing (Method III) (ac)	Fill In SW (Natural) (ac)	Fill In SW (Pond) (ac)	Temp. Fill In SW (ac)	Existing Channel Impacted (ft)	Natural Stream Design (ft)
1	812+00 -L-	8' X 7' RCBC					0.1129			262	
2	868+60 TO 897+27 -L-	BRIDGE									
3	900+00 -L-	36" RCP					0.0378			485	
4	910+00 -L-	8" PVC					0.0138			190	
5	9+00 -LOOP C-	48" RCP					0.0705			619	
6	9+00 -LOOP C-		1.0385			0.0404					
7	952+60 -L-	72"					0.1343			863	
8	27+00 -SRD-		0.000086			0.0027					
9	963+00 -L-						0.0075			97	
10	50+50 -Y1-	42" RCP			0.0077	0.0088	0.0146			128	
11	31+07 TO 39+79 -SRB- 1+00 -RAMP C-	BRIDGE									
TOTALS:			1.04	0.00	0.01	0.05	0.39	0.00	0.00	2644	0.00

NCDOT

DIVISION OF HIGHWAYS
 DAVIDSON/ ROWAN COUNTY
 PROJECT 8.1631403 (I-2304AA)
 I-85 FROM NORTH OF SR 2120 IN
 ROWAN COUNTY TO NORTH OF
 NC 150 IN DAVIDSON COUNTY

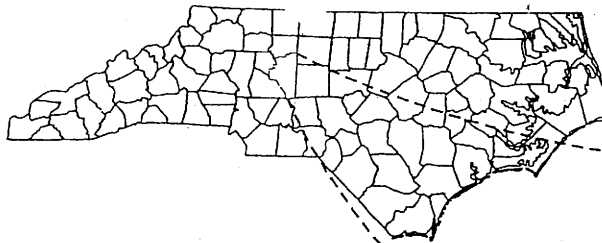

DAVIDSON COUNTY

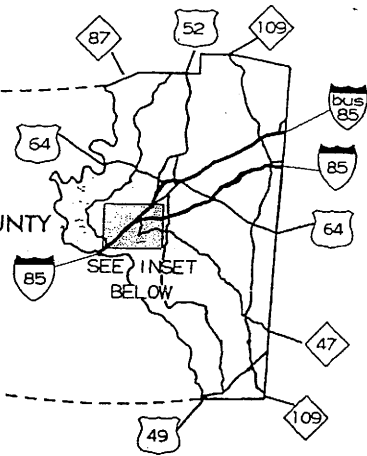

END PROJECT
I-2304AB

SITE 7

SITE 6

SITE 4

SITE 8

SITE 3

SITE 5

SITE 9

SITE 2

SITE 1

SITE 10

BEGIN PROJECT
I-2304AB

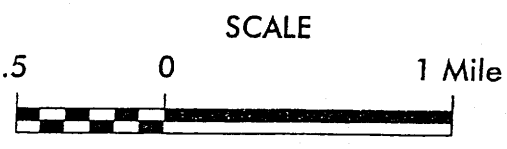
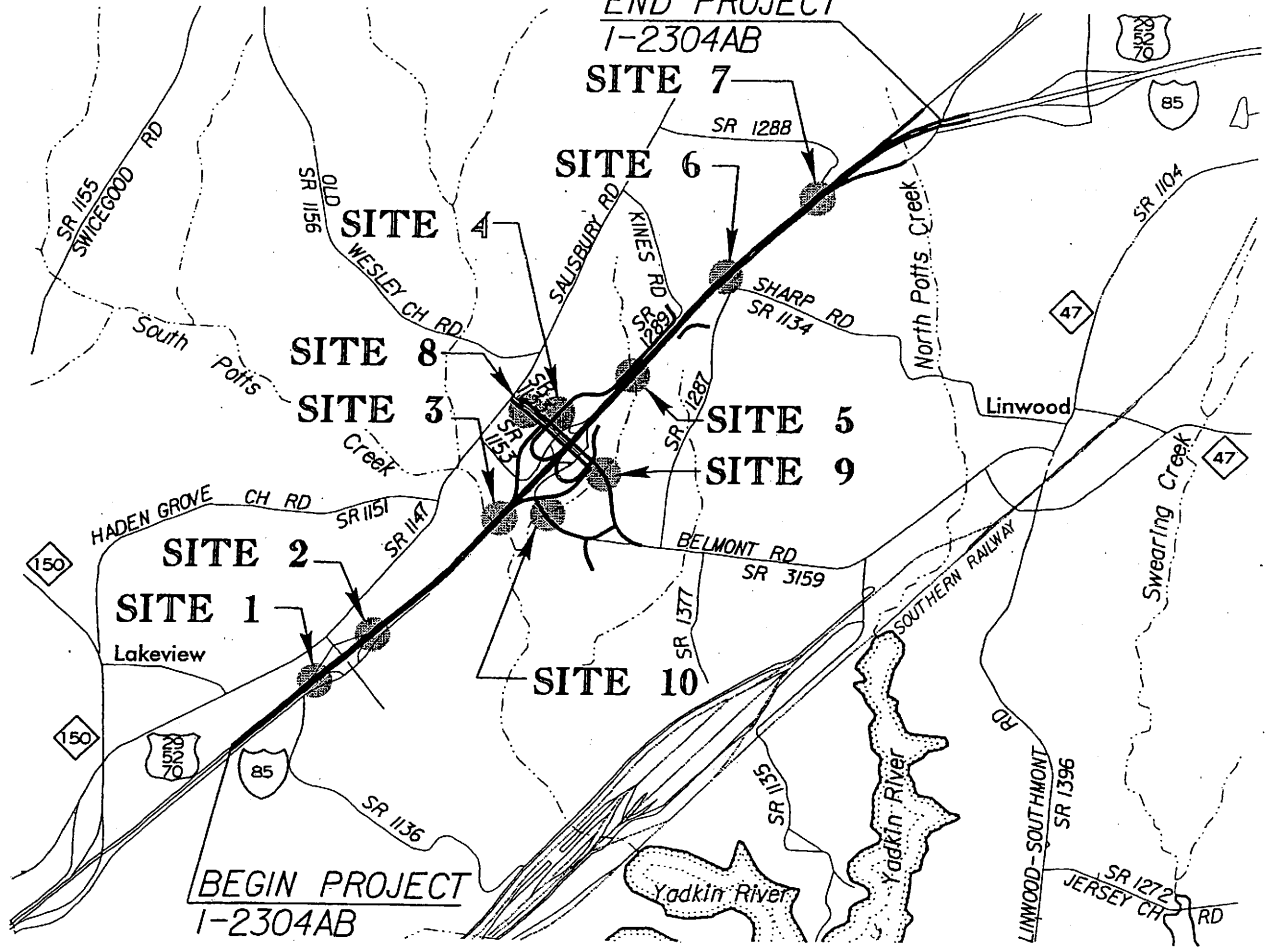

N.C. DEPT. OF TRANSPORTATION
 DIVISION OF HIGHWAYS







DAVIDSON COUNTY

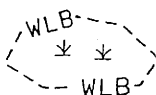
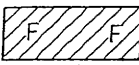
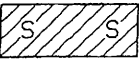

PROJECT: 8.1631403 (I-2304AB)
 I-85 WIDENING FROM JUST NORTH
 OF NC 150 TO JUST NORTH
 OF I-85 BUSINESS

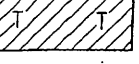
SHEET 1 OF 2

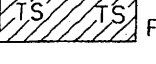
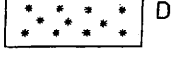
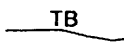
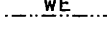

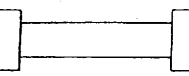
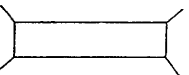

02/24/03

LEGEND

- WLB --- WETLAND BOUNDARY
-  WETLAND
-  DENOTES FILL IN WETLAND
-  DENOTES FILL IN SURFACE WATER
-  DENOTES FILL IN SURFACE WATER (POND)
-  DENOTES TEMPORARY FILL IN WETLAND
-  DENOTES EXCAVATION IN WETLAND
-  DENOTES TEMPORARY FILL IN SURFACE WATER
-  DENOTES MECHANIZED CLEARING
- BZ — RIPARIAN BUFFER ZONE
- ← ← FLOW DIRECTION
-  TOP OF BANK
-  EDGE OF WATER
- C — PROP. LIMIT OF CUT
- F — PROP. LIMIT OF FILL
-  PROP. RIGHT OF WAY
- NG — NATURAL GROUND
- PL — PROPERTY LINE
- TDE — TEMP. DRAINAGE EASEMENT
- PDE — PERMANENT DRAINAGE EASEMENT
- EAB — EXIST. ENDANGERED ANIMAL BOUNDARY
- EPB — EXIST. ENDANGERED PLANT BOUNDARY
- ▽ WATER SURFACE
- X X X LIVE STAKES
-  BOULDER
- COIR FIBER ROLLS

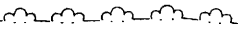
-  PROPOSED BRIDGE
-  PROPOSED BOX CULVERT
-  PROPOSED PIPE CULVERT

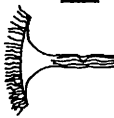
(DASHED LINES DENOTE EXISTING STRUCTURES)

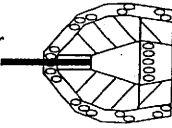
-  SINGLE TREE
-  WOODS LINE
-  DRAINAGE INLET
-  ROOTWAD
-  RIP RAP
-  ADJACENT PROPERTY OWNER OR PARCEL NUMBER IF AVAILABLE
-  RIP RAP ENERGY DISSIPATOR BASIN

N.C. DEPT. OF TRANSPORTATION
DIVISION OF HIGHWAYS

DAVIDSON COUNTY

PROJECT: 8.1631403 (I-2304AB)
I-85 WIDENING FROM JUST NORHT
OF NC 150 TO JUST NORTH
OF I-85 BUSINESS

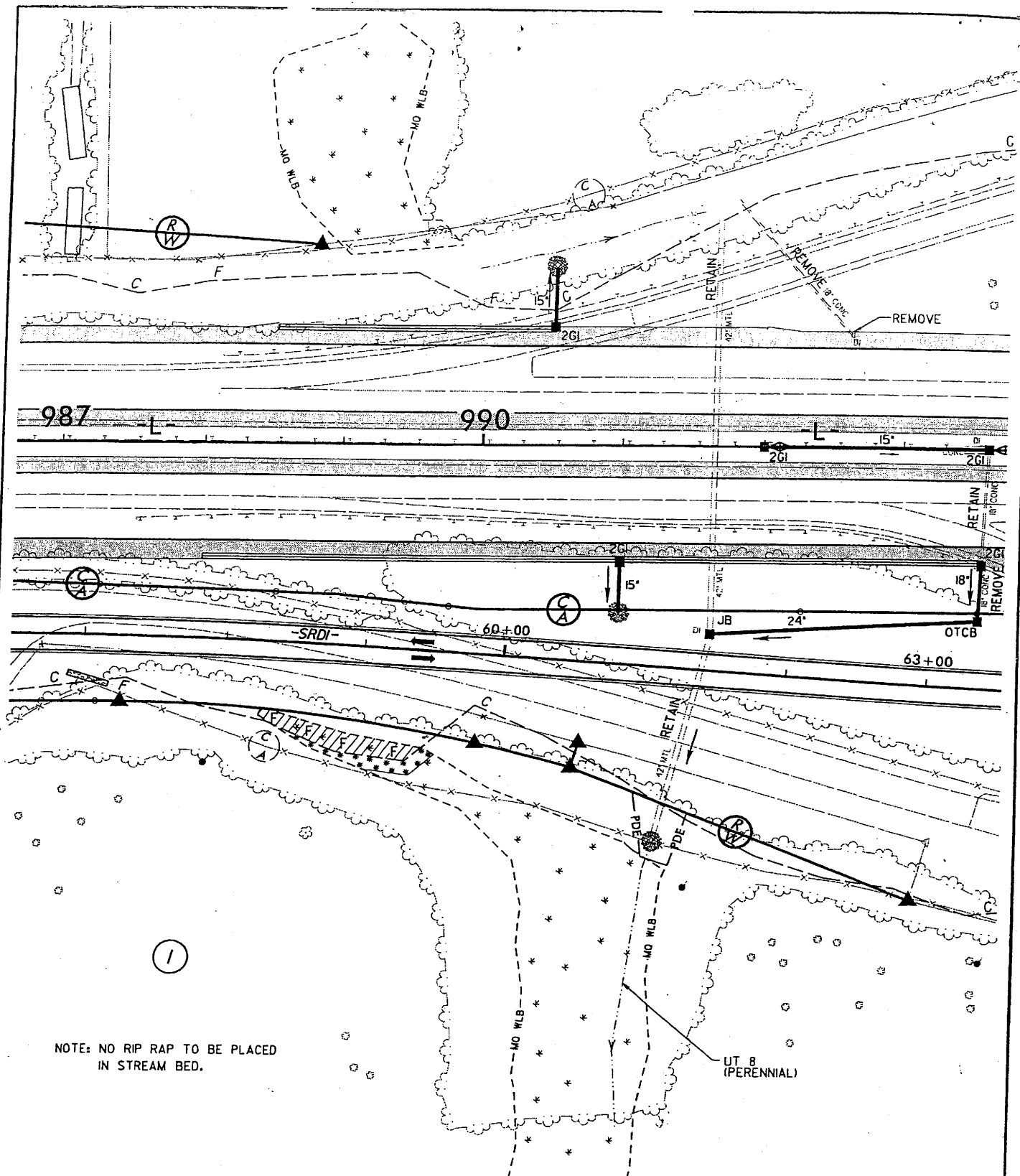

PLAN VIEW
SITE 1



- DENOTES MECHANIZED CLEARING
- DENOTES FILL IN WETLANDS

N.C. DEPT. OF TRANSPORTATION
DIVISION OF HIGHWAYS

DAVIDSON COUNTY

PROJECT: 8.1631403 (I-2304AB)
I-85 WIDENING FROM JUST NORTH
OF NC 150 TO JUST NORTH
OF I-85 BUSINESS

SHEET 3 OF 21

2/24/03

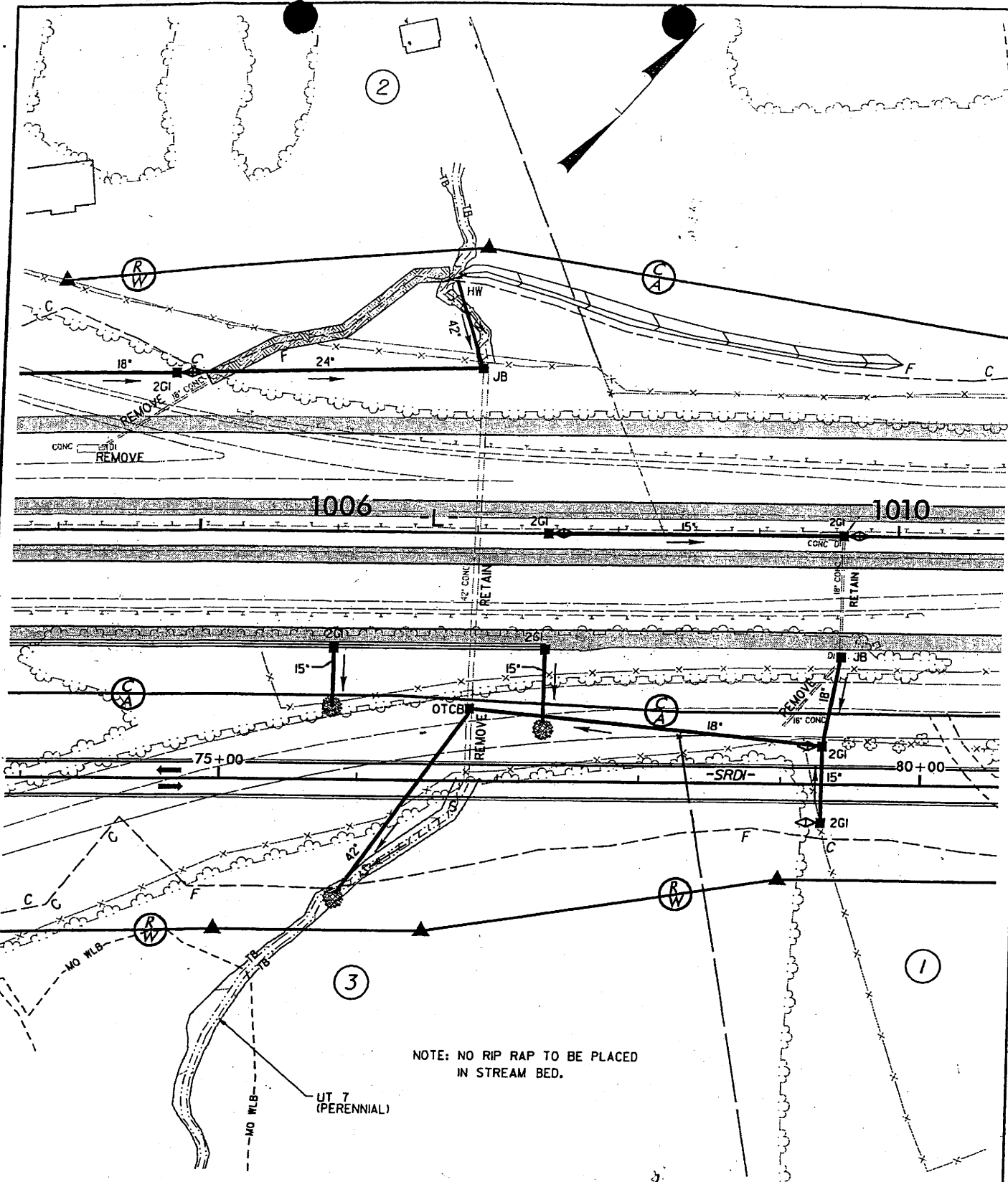

NOTE: NO RIP RAP TO BE PLACED IN STREAM BED.

PLAN VIEW SITE 2

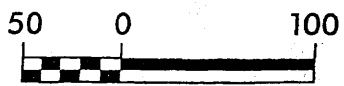

DENOTES FILL IN SURFACE WATERS

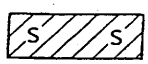

N.C. DEPT. OF TRANSPORTATION
DIVISION OF HIGHWAYS

DAVIDSON COUNTY

PROJECT: 8.1631403 (I-2304AB)
I-85 WIDENING FROM JUST NORTH
OF NC 150 TO JUST NORTH
OF I-85 BUSINESS

SHEET 4 OF 21

2/24/03

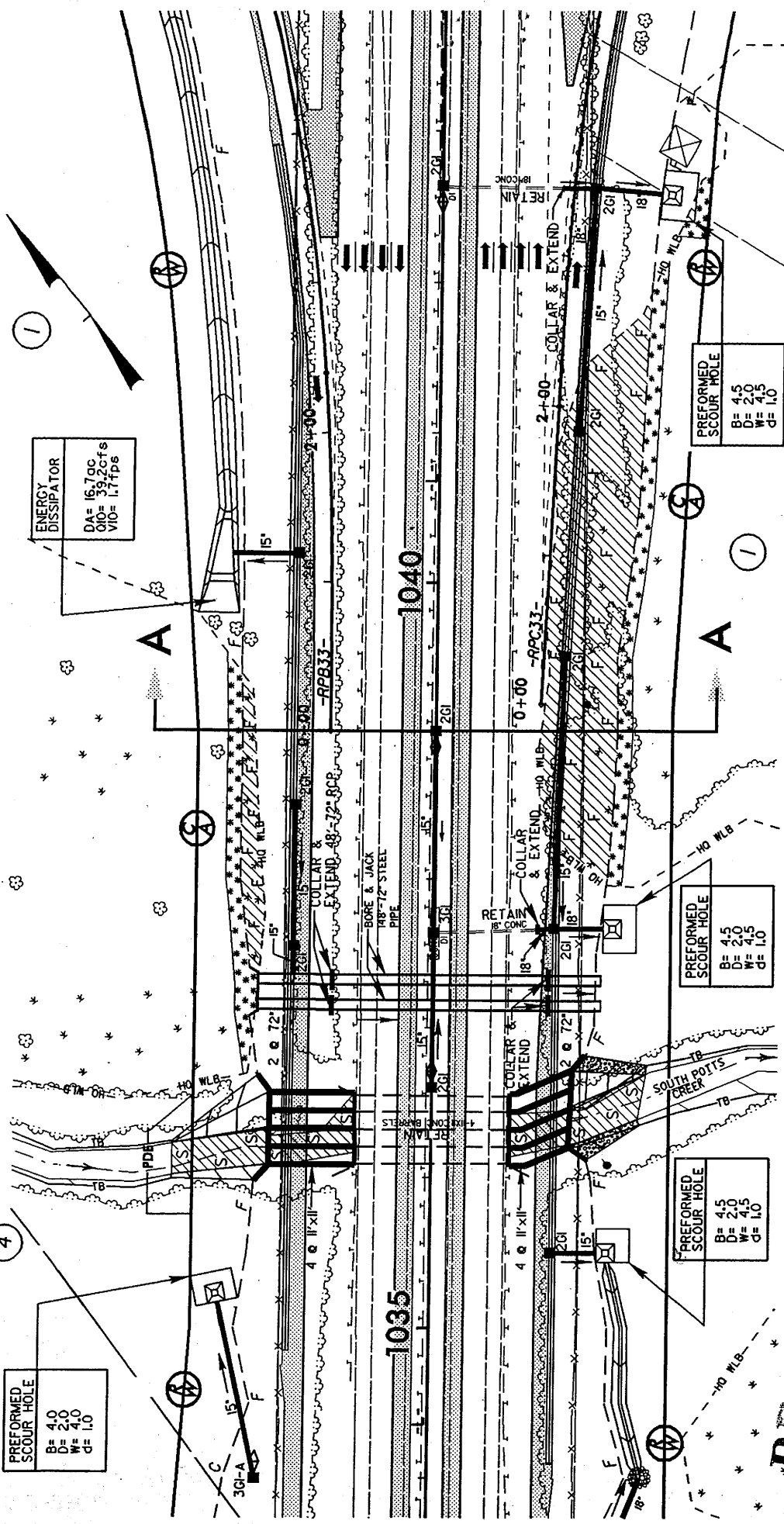

ENERGY DISSIPATOR
 DA= 16.7cc
 O/D= 39.2 Cfs
 V/D= 1.7 f/s

PREFORMED SCOUR HOLE
 B= 4.0
 D= 2.0
 W= 4.0
 C= 1.0

PREFORMED SCOUR HOLE
 B= 4.5
 D= 2.0
 W= 4.5
 C= 1.0

PREFORMED SCOUR HOLE
 B= 4.5
 D= 2.0
 W= 4.5
 C= 1.0

PREFORMED SCOUR HOLE
 B= 4.5
 D= 2.0
 W= 4.5
 C= 1.0

N.C. DEPT. OF TRANSPORTATION
 DIVISION OF HIGHWAYS

DAVIDSON COUNTY
 PROJECT: 8.1631403 (I-2304AB)
 I-85 WIDENING FROM JUST NORTH
 OF NC 150 TO JUST NORTH
 OF I-85 BUSINESS

SHEET 5 OF 21
 2/11/03
 REVISED 3/18/04

PLAN VIEW
 SITE 3

- ***** DENOTES MECHANIZED CLEARING
- ////// DENOTES EXCAVATION IN WETLAND
- ||||| DENOTES FILL IN WETLANDS
- ||||| DENOTES FILL IN SURFACE WATERS

NOTE: HAND CLEAR IN WETLANDS TO INSTALL CONTROLLED ACCESS FENCING.

RECEIVED 1
 4 2004

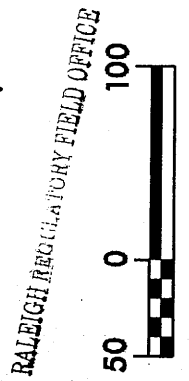

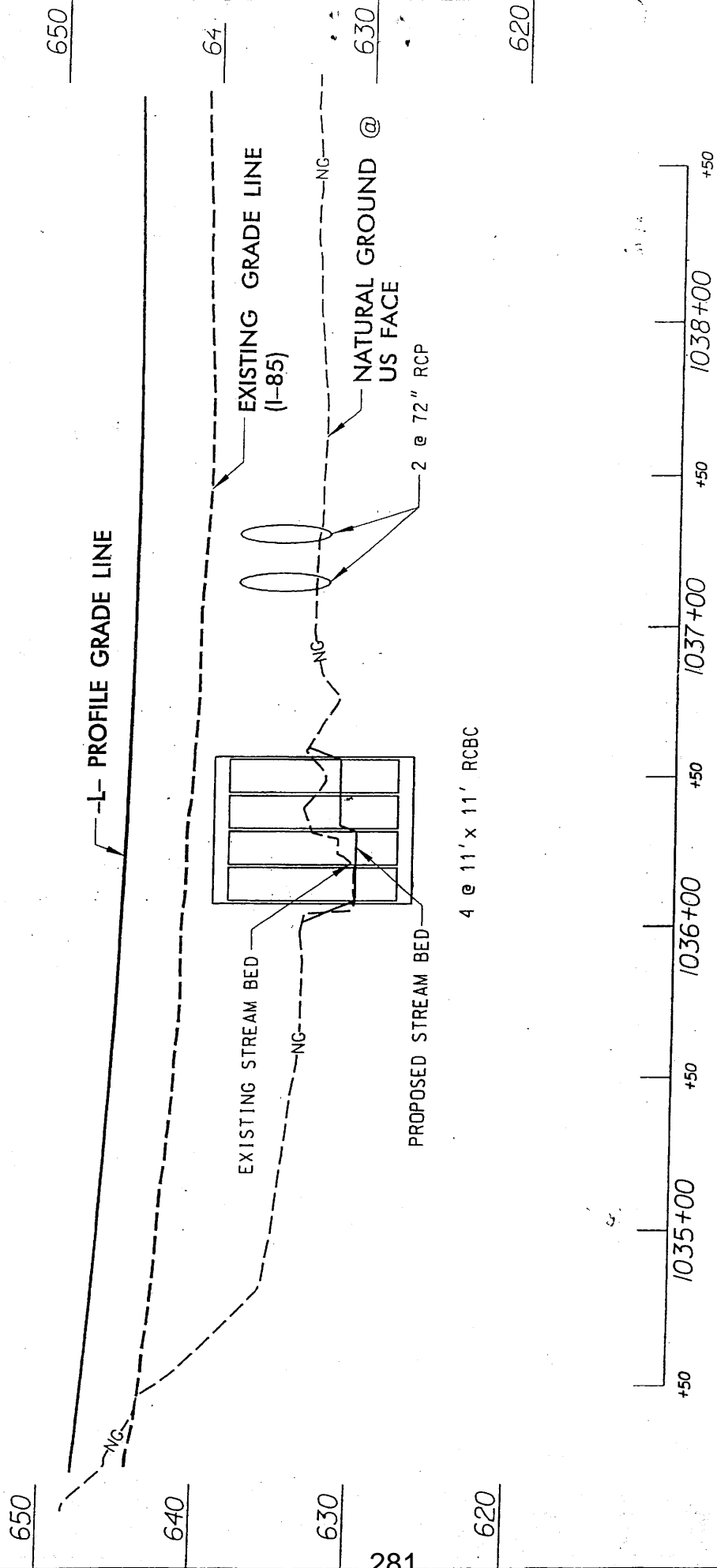

PROFILE SITE 3

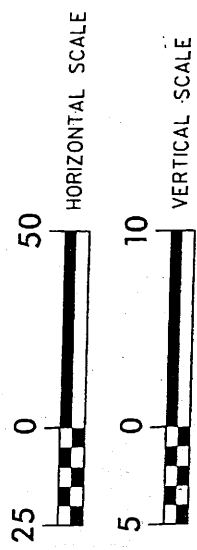

N.C. DEPT. OF TRANSPORTATION
DIVISION OF HIGHWAYS

DAVIDSON COUNTY

PROJECT: 8.1631403 (I-2504AB)
I-85 WIDENING FROM JUST NORTH
OF NC 150 TO JUST NORTH
OF I-85 BUSINESS

SHEET 2 OF 21

2/24/03

☉ 1039+00 -L-

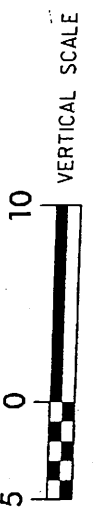
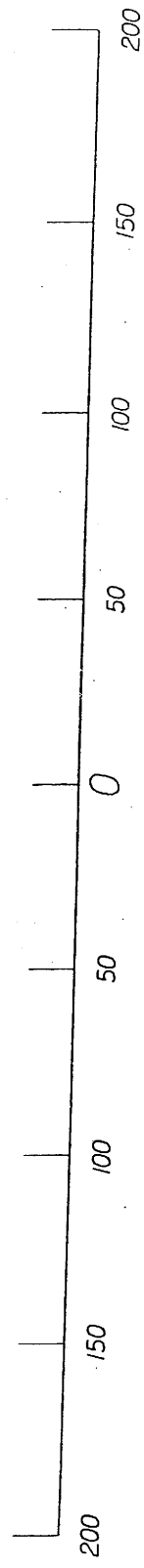
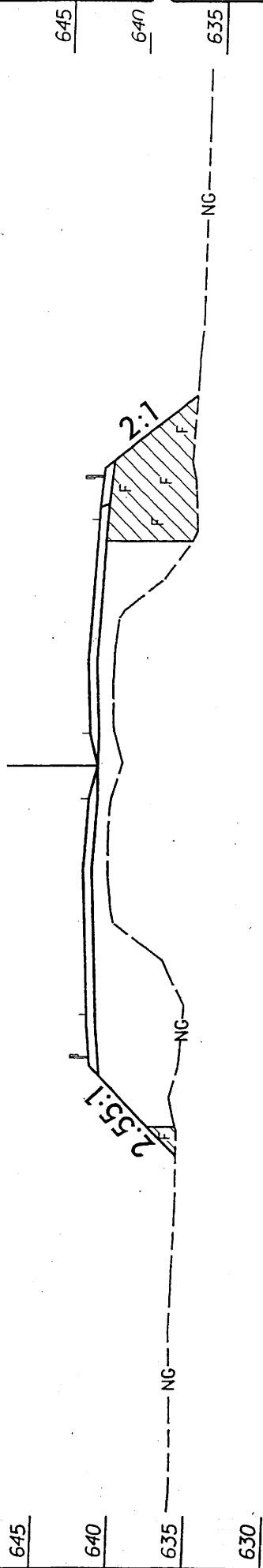

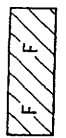
 DENOTES FILL IN WETLANDS

SITE 3
SECTION A-A

N.C. DEPT. OF TRANSPORTATION
 DIVISION OF HIGHWAYS
 DAVIDSON COUNTY
 PROJECT: 81631403 (I-2304AB)
 I-85 WIDENING FROM JUST NORTH
 OF NC 150 TO JUST NORTH
 OF I-85 BUSINESS
 SHEET 7 OF 21

2/24/03

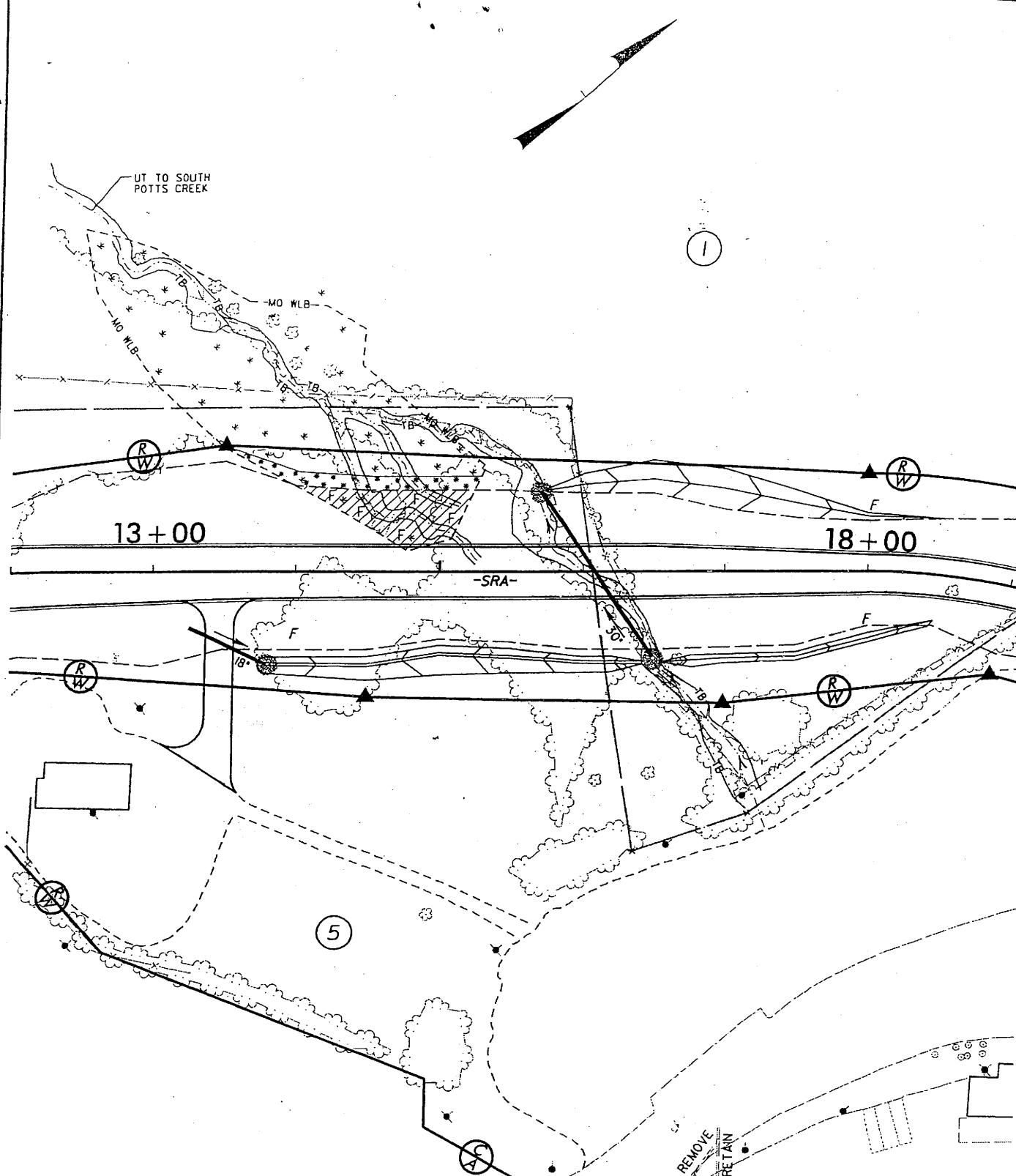

PLAN VIEW
SITE 4

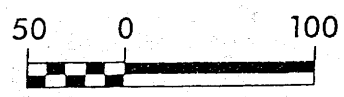

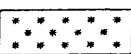
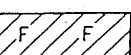
DENOTES MECHANIZED CLEARING 
 DENOTES FILL IN WETLANDS 

283

N.C. DEPT. OF TRANSPORTATION
 DIVISION OF HIGHWAYS

 DAVIDSON COUNTY
 PROJECT: 8.1631403 (I-2304AB)
 I-85 WIDENING FROM JUST NORTH
 OF NC 150 TO JUST NORTH
 OF I-85 BUSINESS
 SHEET 8 OF 21 2/24/03

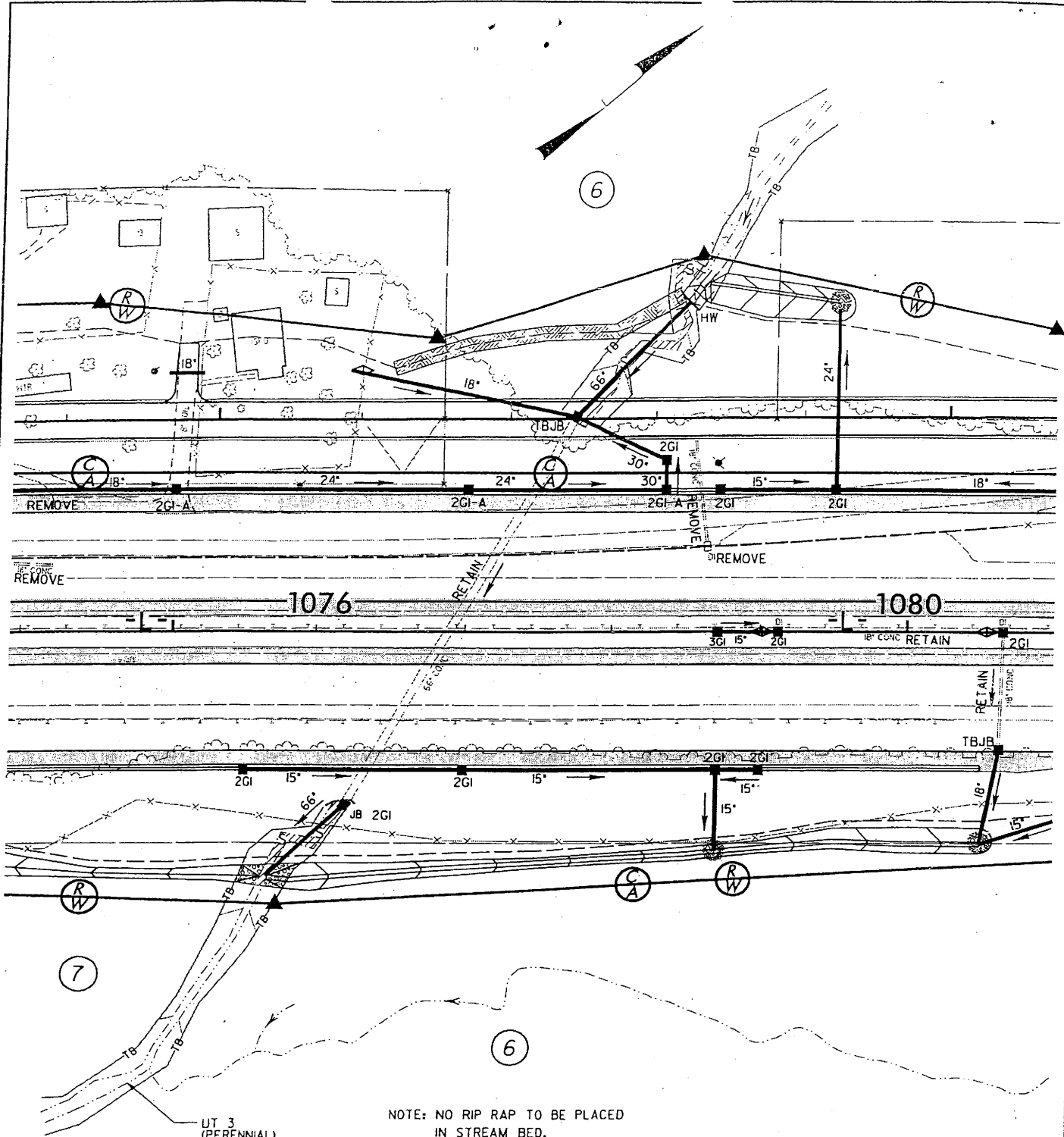

PLAN VIEW
SITE 5

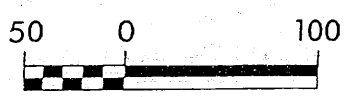

DENOTES FILL IN SURFACE WATERS

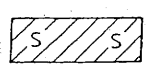

N.C. DEPT. OF TRANSPORTATION
DIVISION OF HIGHWAYS

DAVIDSON COUNTY

PROJECT: 8.1631403 (I-2304AB)
I-85 WIDENING FROM JUST NORTH
OF NC 150 TO JUST NORTH
OF I-85 BUSINESS

SHEET 9 OF 21

2/24/03

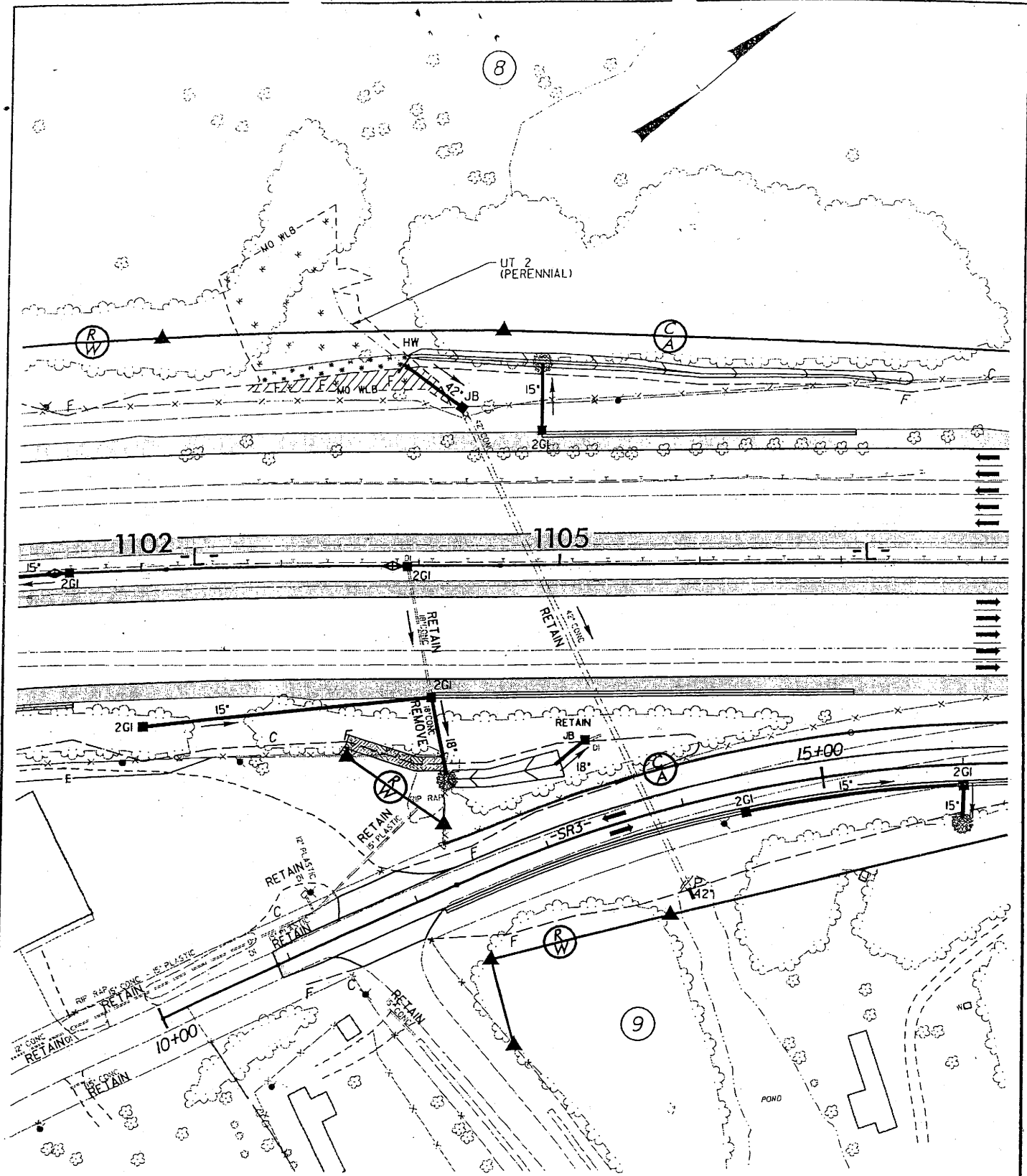

**PLAN VIEW
SITE 6**

NOTE: HAND CLEAR IN WETLANDS
TO INSTALL CONTROLLED
ACCESS FENCING.

DENOTES MECHANIZED
CLEARING

DENOTES FILL IN
WETLANDS

DENOTES FILL IN
SURFACE WATERS
(POND)

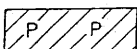

N.C. DEPT. OF TRANSPORTATION
DIVISION OF HIGHWAYS

DAVIDSON COUNTY

PROJECT: 8.1631403 (I-2304AB)
I-85 WIDENING FROM JUST NORTH
OF NC 150 TO JUST NORTH
OF I-85 BUSINESS

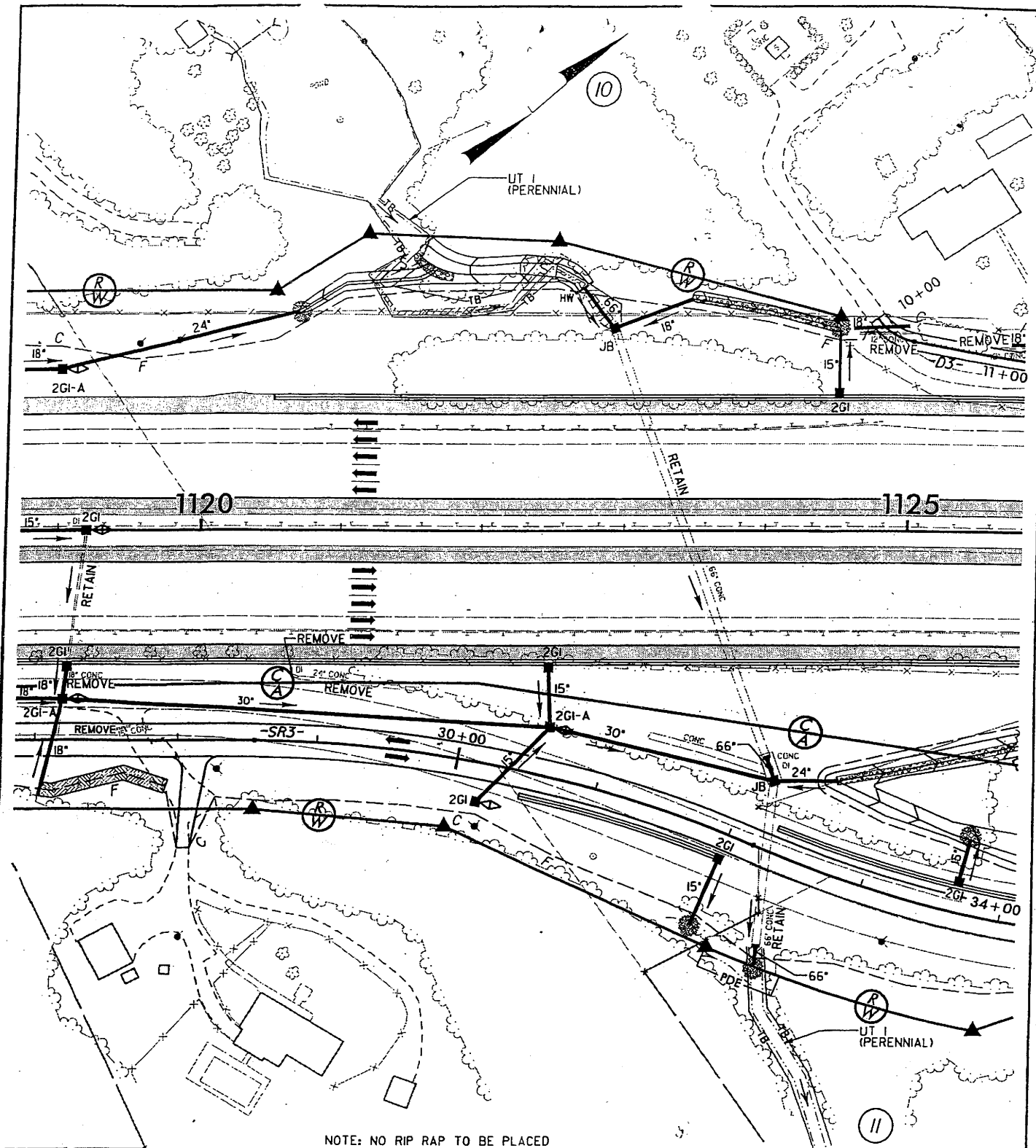

NOTE: NO RIP RAP TO BE PLACED
IN STREAM BED.

PLAN VIEW SITE 7

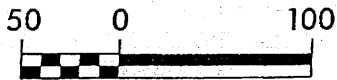

DENOTES FILL IN
SURFACE WATERS

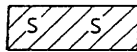

N.C. DEPT. OF TRANSPORTATION
DIVISION OF HIGHWAYS

DAVIDSON COUNTY

PROJECT: 8.1631403 (I-2304AB)
I-85 WIDENING FROM JUST NORTH
OF I-85 BUSINESS

SHEET 11 OF 21

2/24/03

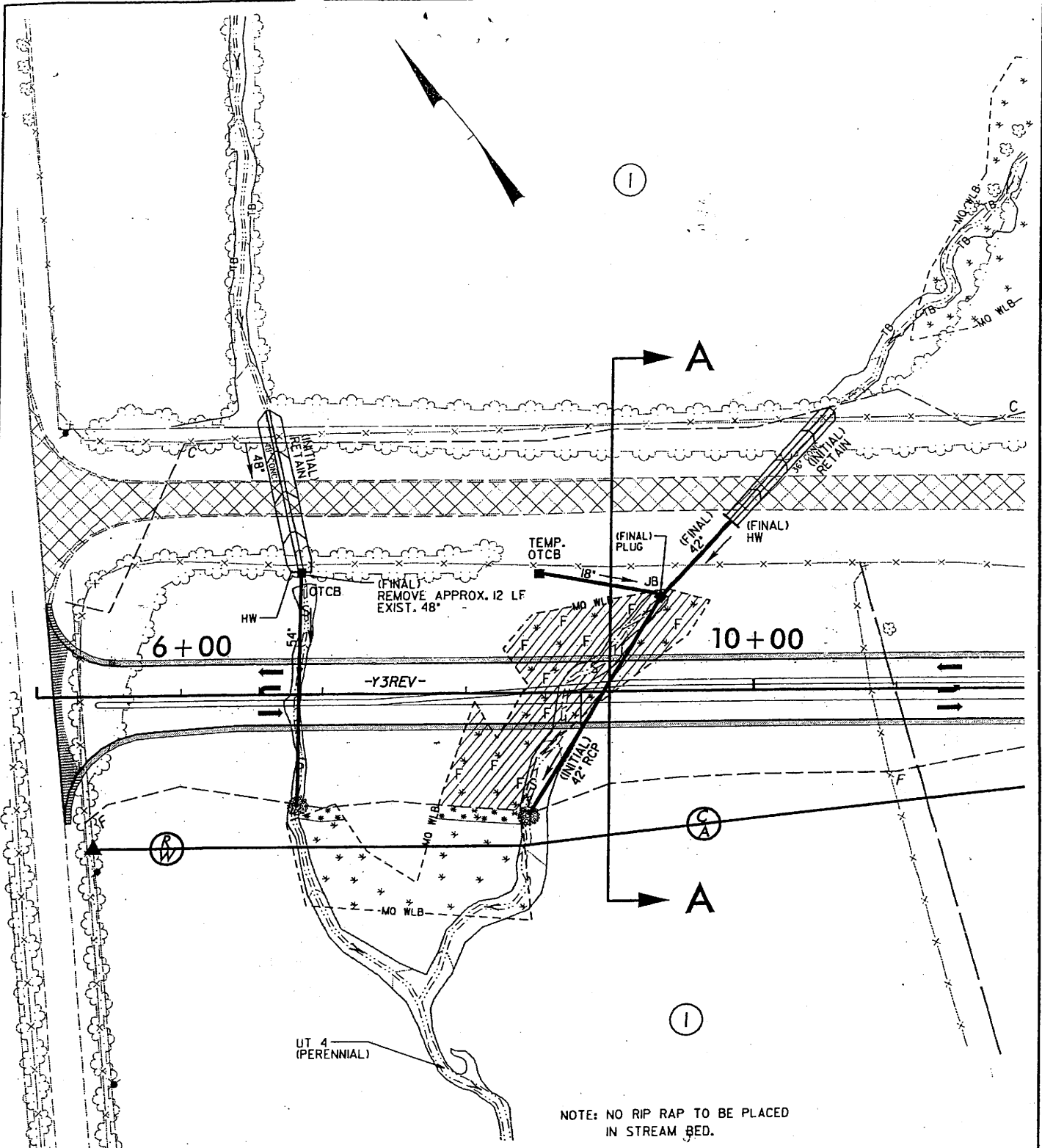

PLAN VIEW SITE 8

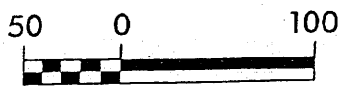

- DENOTES MECHANIZED CLEARING
- DENOTES FILL IN WETLANDS
- DENOTES FILL IN SURFACE WATERS

N.C. DEPT. OF TRANSPORTATION
DIVISION OF HIGHWAYS

DAVIDSON COUNTY

PROJECT: 8.1631403 (I-2304AB)
I-85 WIDENING FROM JUST NORTH
OF NC 150 TO JUST NORTH
OF I-85 BUSINESS

SHEET 12 OF 21 2 / 24 / 03

700

690

680

670

660

700

690

680

670

660

-Y3REV- PROFILE GRADE LINE

NATURAL GROUND

54" RCP

42" RCP

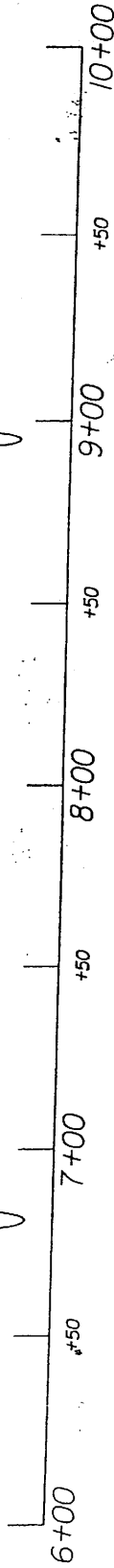

PROFILE SITE 8

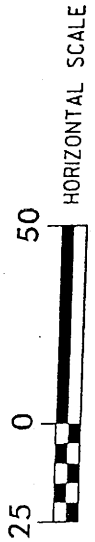

DNOTES FILL IN SURFACE WATERS



DNOTES FILL IN WETLANDS

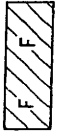

N.C. DEPT. OF TRANSPORTATION
DIVISION OF HIGHWAYS

DAVIDSON COUNTY

PROJECT: 8.1631403 (I-2304AB)
I-85 WIDENING FROM JUST NORTH
OF NC 150 TO JUST NORTH
OF I-85 BUSINESS

SHEET 13 OF 21 2/24/03

9 + 00 - Y3REV-

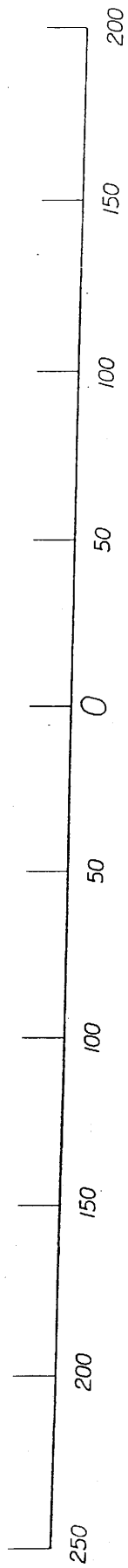
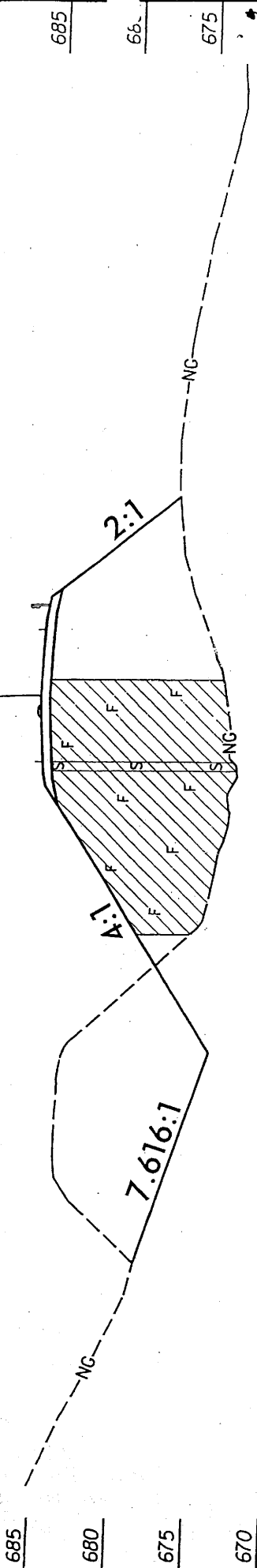

SITE 8
SECTION A-A

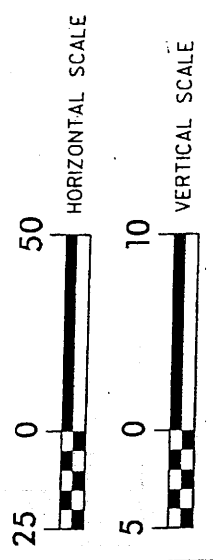

DENOTES FILL IN
 SURFACE WATERS
 DENOTES FILL IN
 WETLANDS

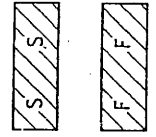

N.C. DEPT. OF TRANSPORTATION
 DIVISION OF HIGHWAYS
 DAVIDSON COUNTY
 PROJECT: 81631403 (I-2304AB)
 I-85 WIDENING FROM JUST NORTH
 OF NC 150 TO JUST NORTH
 OF I-85 BUSINESS
 SHEET 14 OF 21
 2 / 24 / 03

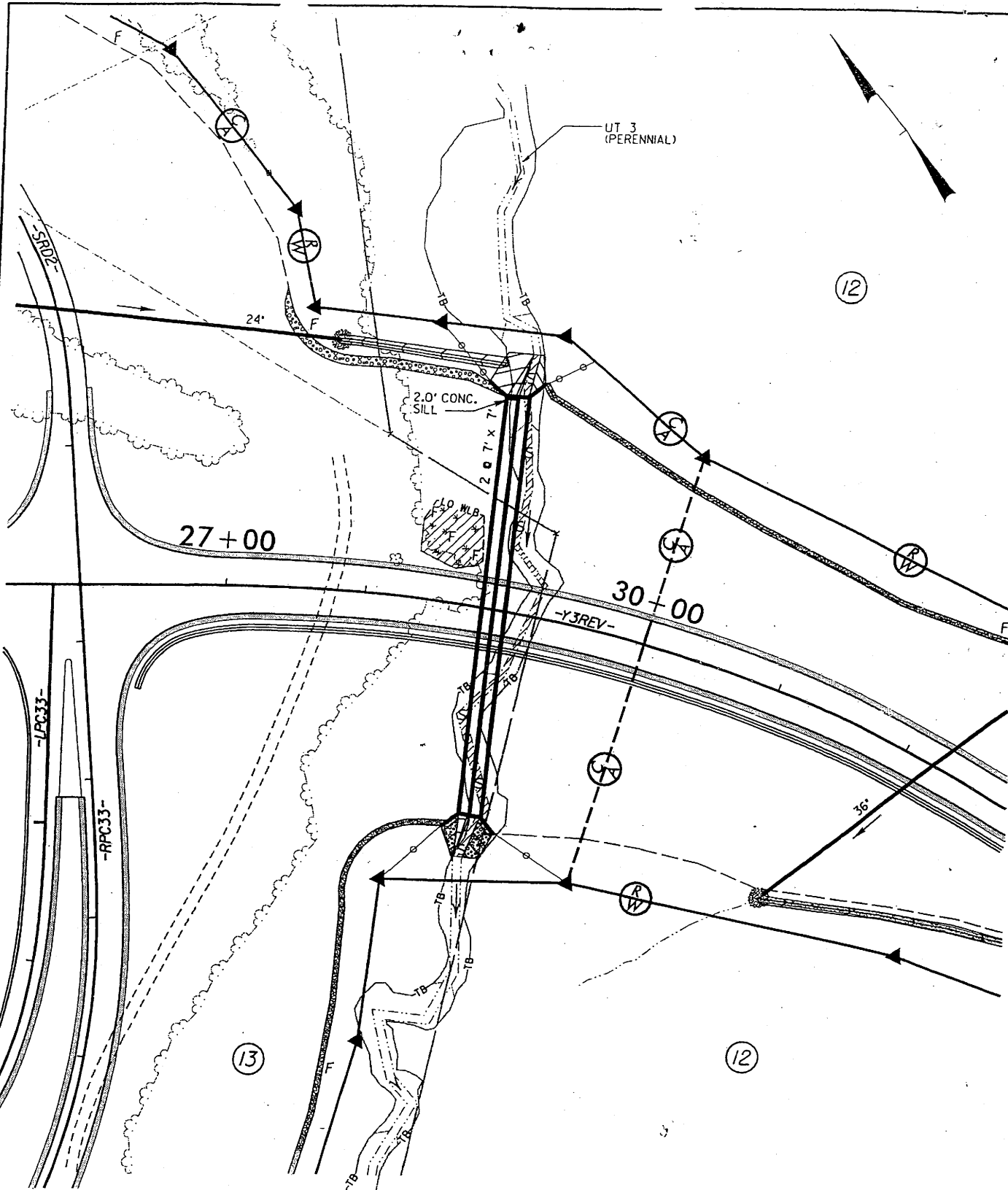

PLAN VIEW
SITE 9



DENOTES FILL IN
WETLANDS



DENOTES FILL IN
SURFACE WATERS



N.C. DEPT. OF TRANSPORTATION
DIVISION OF HIGHWAYS

DAVIDSON COUNTY

PROJECT: 8.1631403 (I-2304AB)
I-85 WIDENING FROM JUST NORTH
OF NC 150 TO JUST NORTH
OF I-85 BUSINESS

SHEET 15 OF 21

2/24/03

-Y3REV- PROFILE GRADE LINE

(-)2.9360%

720

700

680

660

640

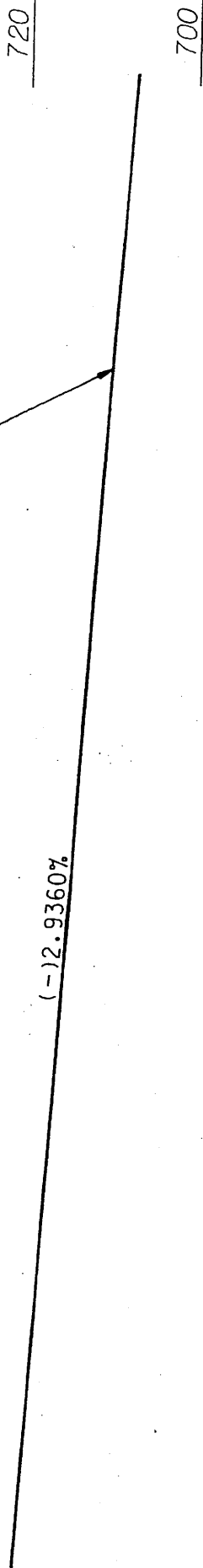

NATURAL GROUND LINE @ US FACE

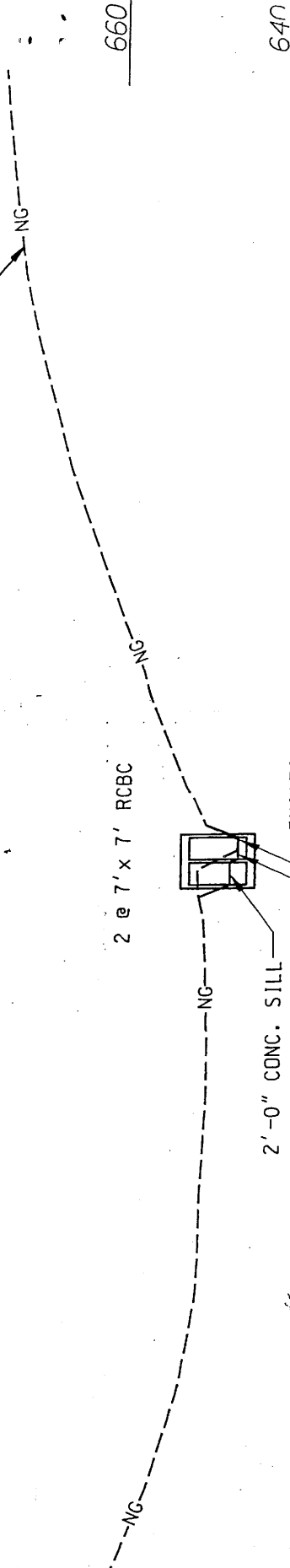

2 @ 7' x 7' RCBC



2'-0" CONC. SILL

PROPOSED STREAM BED

EXISTING STREAM BED

27+00

28+00

29+00

30+00

31+00

+50

+50

+50

+50

+50

PROFILE SITE 9



N.C. DEPT. OF TRANSPORTATION
DIVISION OF HIGHWAYS

DAVIDSON COUNTY

PROJECT: 8.1631403 (I-2304AB)

I-85 WIDENING FROM JUST NORTH
OF NC 150 TO JUST NORTH
OF I-85 BUSINESS

SHEET 16 OF 21

2/24/03

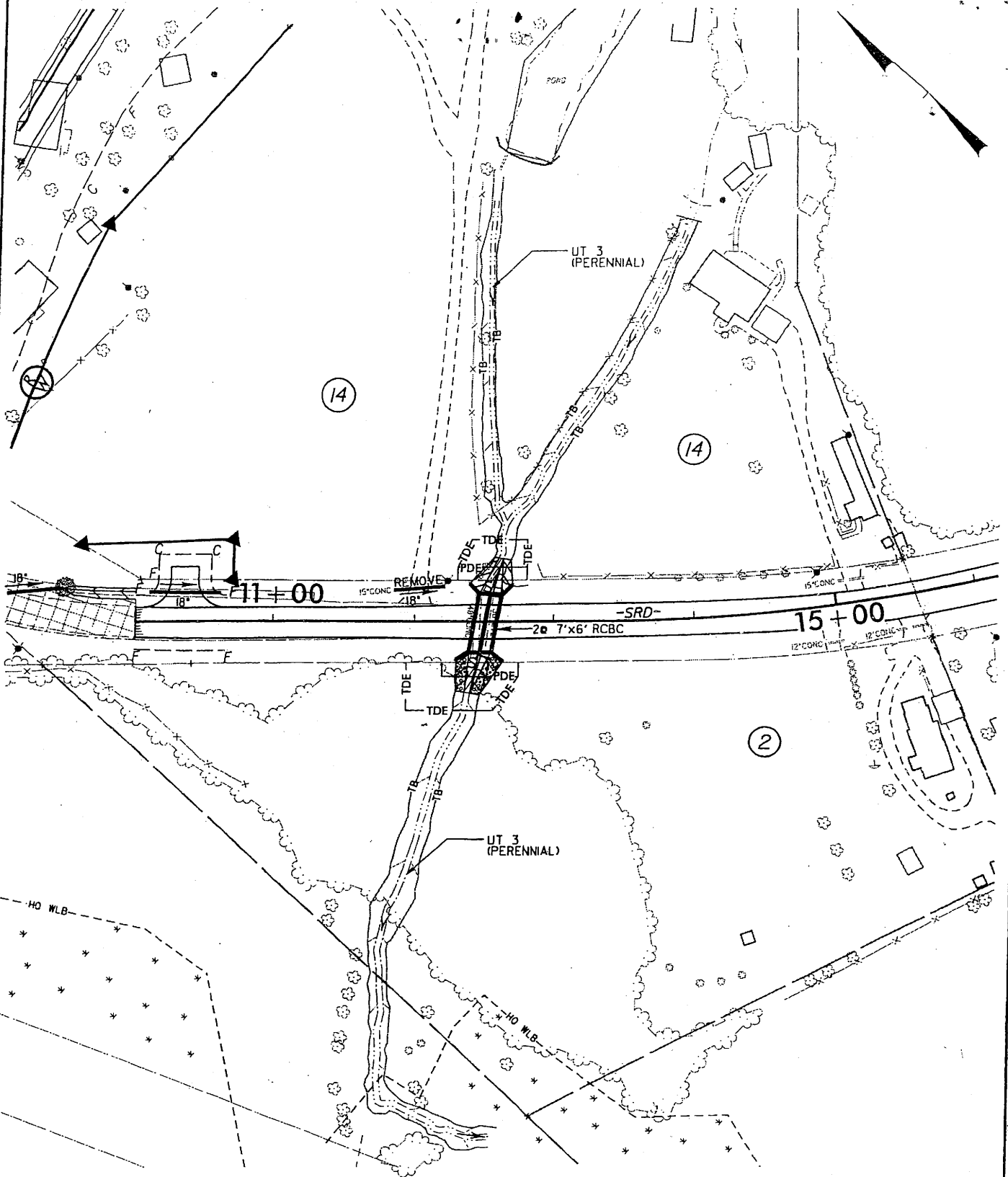

PLAN VIEW
SITE 10



DENOTES FILL IN
SURFACE WATERS



N.C. DEPT. OF TRANSPORTATION
DIVISION OF HIGHWAYS

DAVIDSON COUNTY

PROJECT: 8.1631403 (I-2304AB)
I-85 WIDENING FROM JUST NORTH
OF NC 150 TO JUST NORTH
OF I-85 BUSINESS

SHEET 17 OF 21

2 / 24 / 03

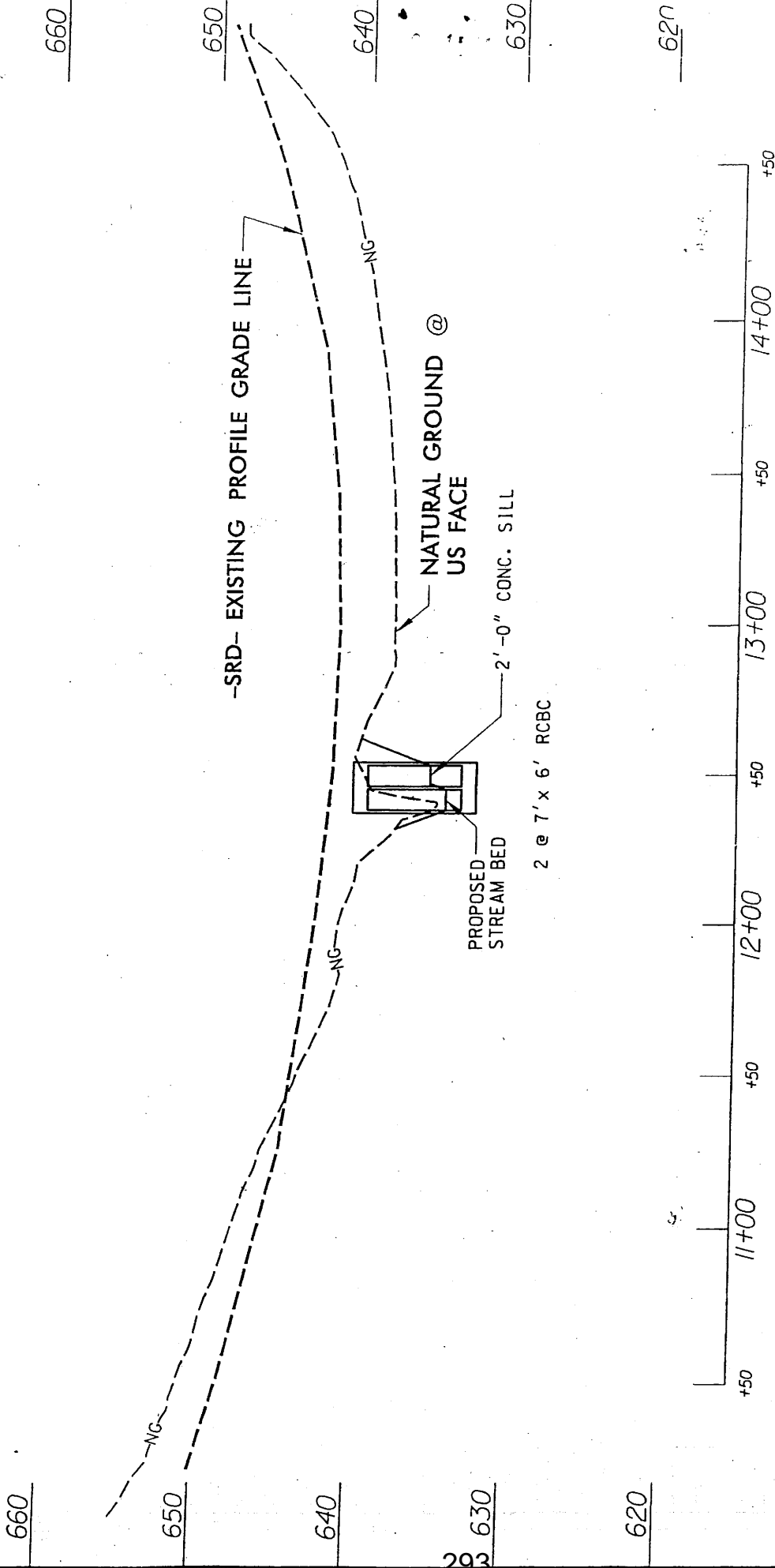

PROFILE SITE 10

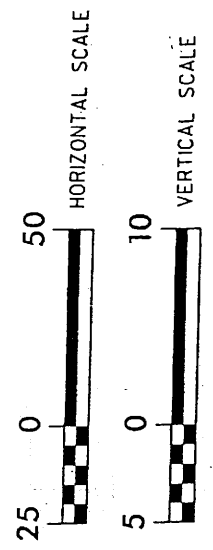

N.C. DEPT. OF TRANSPORTATION
DIVISION OF HIGHWAYS

DAVIDSON COUNTY

PROJECT: 8.1631403 (I-2304AB)
I-85 WIDENING FROM JUST NORTH
OF NC 150 TO JUST NORTH
OF I-85 BUSINESS

SHEET 18 OF 24

2/24/03

WETLAND PERMIT IMPACT SUMMARY

Site No.	Station (From / To)	Structure / Type	Size	WETLAND IMPACTS			SURFACE WATER IMPACTS								
				Fill In Wetlands (ac)	Temp. Fill In Wetlands (ac)	Excavation In Wetlands (ac)	Mechanized Clearing (Method III) (ac)	Fill In SW (Natural) (ac)	Fill In SW (Pond) (ac)	Temp. Fill In SW (ac)	Existing Channel Impacted (ft)	Natural Stream Design Depth (ft)			
1	-L- 988+45R / -L- 989+70R			0.033			0.019								
2	-L- 1006+08R / -L- 1007+00L	1 @ 42" RCP						0.021					219		
3	-L- 1036+00 / -L- 1042+70R	4 @ 11" x 11" RCBC w/ 2 @ 72"		0.463		0.016	0.171	0.062					216		
4	-SRA- 13+50L / -SRA- 16+70R	1 @ 30" RCP		0.071			0.036								
5	-L- 1075+70R / -L- 1078+70R	1 @ 66" RCP													
6	-L- 1102+75L / -L- 1106+10R	1 @ 42" RCP		0.037			0.026	0.034					270		
7	-L- 1121+15L / -L- 1124+05R	1 @ 66" RCP							0.003						
8	-Y3REV- 6+50R / -Y3REV- 6+92L -Y3REV- 7+80R / -Y3REV- 9+70R	1 @ 54" RCP 1 @ 42" RCP		0.263			0.005 0.003	0.009 0.014					179 201		
9	-Y3REV- 28+65L / -Y3REV- 29+35R	2 @ 7' x 7' RCBC w/ 2' CONC. SILL		0.039				0.042					395		
10	-SRD- 12+28R / -SRD- 12+78L	2 @ 7' x 6' RCBC w/ 2' CONC. SILL						0.006					59		
TOTALS:				0.906	0.000	0.016	0.266	0.218	0.003	0.000	1811	0			

N.C. DEPARTMENT OF TRANSPORTATION
 DIVISION OF HIGHWAYS

 DAVIDSON COUNTY

 PROJECT 8.1631403 (I-2304AB)
 I-85 WIDENING FROM JUST NORTH
 OF NC 150 TO JUST NORTH OF
 I-85 BUSINESS

Property Owner List

Site NO.	Parcel NO.	Name DB and Pg	Address
1	①	Robert L. Grubb Trustee of June C. Little DB 698 Pg 336	P.O. BOX 388 High Point, NC 27260
2	①	Robert L. Grubb Trustee of June C. Little DB 698 Pg 336	P.O. BOX 388 High Point, NC 27260
	②	Franklin Haywood Graves And Wife, Margaret L Graves DB 635 Pg 17 DB 915 Pg 965 DB 401 Pg 338	8291 Old Salisbury Road Linwood, NC 27299-9708
	③	Everhart Used Cars, Inc. DB 635 Pg 161	1517 Greensboro Road Lexington NC 27292-1919
3	①	Robert L. Grubb Trustee of June C. Little DB 699 Pg 336	P.O. BOX 388 High Point, NC 27260
	④	Earl L Blanton And Wife, Kathy L Blanton DB 705 Pg 514	7847 Old Salisbury Road Linwood, NC 27299
4	①	Robert L. Grubb Trustee of June C. Little DB 699 Pg 336	P.O. BOX 388 High Point, NC 27260
	⑤	Walser Enterprises DB 112 Pg 110	Snider-Kines Road Linwood, NC 27299
5	⑥	C. C. Fitzgerald Heirs DB 57 Pg 205	194 Redwine Road Linwood, NC 27299
	⑦	Randall G Lomax And Wife, Tammy P Lomax DB 875 Pg 936	310 Lake Shore Drive Lexington, NC 27292-8117

N.C. DEPT. OF TRANSPORTATION
 DIVISION OF HIGHWAYS
 DAVIDSON COUNTY
 PROJECT: 8.1631403 (I-2304AB)
 I-85 WIDENING FROM JUST NORTH
 OF NC 150 TO JUST NORTH
 OF I-85 BUSINESS
 SHEET 20 OF 21 2/24/03

Property Owner List

Site NO.	Parcel NO.	Name DB and Pg	Address
6	8	Mobile Development Corp. DB 1051 Pg 1588	23 West Second Street Lexington, NC 27292
	9	Robert A. Gusman DB 634 Pg 656 DB 613 Pg 959	P.O. Box 992 Lexington, NC 27293-0992
7	10	George W Gobble And Wife, Betty E Gobble DB 596 Pg 757	984 Wayane Gobble Road Linwood, NC 27299-9706
	11	Margaret N. Clark DB 832 Pg 814	1089 Clyde Fitzgerald Road Linwood, NC 27299
8	1	Robert L. Grubb Trustee of June C. Little DB 699 Pg 336	P.O. BOX 388 High Point, NC 27260
9	12	Beallmont Farms Inc. DB 931 Pg 628	P.O. Box 835 Linwood, NC 27299
	13	Henderson Hargrave Heirs DB 102 Pg 288	561 Belmont Road Linwood, NC 27299-9201
10	2	Walter McDowell, SR DB 550 Pg 769	796 Belmont Road Linwood, NC 27299-9201
	14	Henderson Hargrave Heirs DB 102 Pg 288	561 Belmont Road Linwood, NC 27299-9201

N.C. DEPT. OF TRANSPORTATION
 DIVISION OF HIGHWAYS
 DAVIDSON COUNTY
 PROJECT: 8.1631403 (I-2304AB)
 I-85 WIDENING FROM JUST NORHT
 OF NC 150 TO JUST NORTH
 OF I-85 BUSINESS
 SHEET 21 OF 21 2/24/03



REPLY TO
ATTENTION OF:

DEPARTMENT OF THE ARMY
WILMINGTON DISTRICT, CORPS OF ENGINEERS
69 DARLINGTON AVENUE
WILMINGTON, NORTH CAROLINA 28403-1343

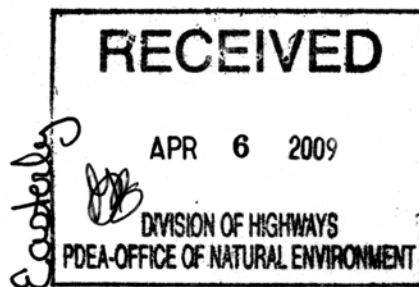

April 1, 2009

Regulatory Division

Action ID. 199821203; TIP No. I-23⁹4A

Dr. Gregory J. Thorpe, Ph.D.
Environmental Management Director, PDEA
N.C. Department of Transportation
1598 Mail Service Center
Raleigh, North Carolina 27699-1598

Dear Dr. Thorpe:

Reference is made to your Department of the Army (DA) permit issued on December 16, 2004, authorizing the discharge of fill material into waters of the United States (jurisdictional waters) for construction of Section A of the Interstate 85 (I-85) Improvements (T.I.P. No. I-2304A), from north of SR 2120 (Exit 81), northeast of Spence, in Rowan County, to north of I-85 Business (Exit 87), southwest of Lexington, in Davidson County, North Carolina. The project is adjacent to jurisdictional waters of the Yadkin River, Potts Creek, and unnamed tributaries of the Yadkin River.

Reference is also made to your written request of February 20, 2009, to extend your DA permit. As stated in your request the project was scheduled to start construction in 2004; however, funding for the project was cut and construction of the project was never started. At this time, new funding for the project is anticipated and the NCDOT plans to proceed with construction. The current DA permit for the project has an expiration date of December 31, 2009. It is expected that the project including the replacement and demolition of several bridges will take four years to complete. Therefore, you have requested a four year extension of your current DA permit. In accordance with your request, your permit is hereby extended until December 31, 2013. All other conditions of the original permit remain in full force and effect.

If the permitted work is not completed on or before the date herein specified, the authorization, if not previously revoked or specifically further extended, will cease and become null and void. If additional time is required to complete the project, you should contact this office with a request for an additional time extension.

Should you have questions, please contact Mr. John Thomas, Raleigh Regulatory Field Office, telephone (919) 554-4884 extension 25.

Sincerely,

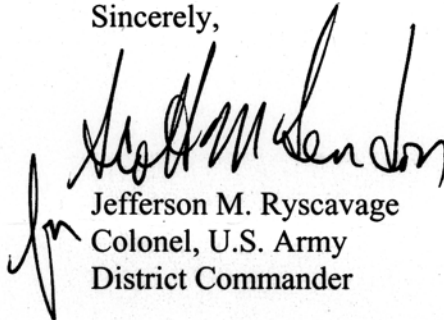

Jefferson M. Ryscavage
Colonel, U.S. Army
District Commander

Copies furnished:

Mr. Brian Wrenn
Division of Water Quality
North Carolina Department of Environment
and Natural Resources
1650 Mail Service Center
Raleigh, North Carolina 27699-1650

Mr. Travis Wilson
Eastern Region Highway Project Coordinator
Habitat Conservation Program
1142 I-85 Service Road
Creedmoor, North Carolina 27522

Mr. Pete Benjamin
U.S. Fish and Wildlife Service
Fish and Wildlife Enhancement
Post Office Box 33726
Raleigh, North Carolina 27636-3726

Mr. Chris Militscher
C/O FHWA
U.S. Environmental Protection Agency
Raleigh Office
310 New Bern Avenue, Room 206
Raleigh, North Carolina 27601

***** STANDARD SPECIAL PROVISIONS *******LIABILITY INSURANCE:**

(11-18-08)

DB1 G80

Revise the 2006 Standard Specifications as follows:

Page 1-68, Article 107-16 is amended to include the following as the first, second, third and fourth paragraphs:

The Design-Build Team shall be liable for any losses resulting from a breach of the terms of this contract. The Design-Build Team shall be liable for any losses due to the negligence or willful misconduct of its agents, assigns and employees including any sub-contractors which causes damage to others for which the Department is found liable under the Torts Claims Act, or in the General Courts of Justice, provided the Department provides prompt notice to the Design-Build Team and that the Design-Build Team has an opportunity to defend against such claims. The Design-Build Team shall not be responsible for punitive damages.

The Design-Build Team shall at its sole cost and expense obtain and furnish to the Department an original standard ACORD form certificate of insurance evidencing commercial general liability with a limit for bodily injury and property damage in the amount of \$5,000,000.00 per occurrence and general aggregate, covering the Design-Build Team from claims or damages for bodily injury, personal injury, or for property damages which may arise from operating under the contract by the employees and agents of the Design-Build Team. The required limit of insurance may be obtained by a single general liability policy or the combination of a general liability and excess liability or umbrella policy. The State of North Carolina shall be named as an additional insured on this commercial general liability policy. The policy may contain the following language as relates to the State as an additional insured: "This insurance with respect to the additional insured applies only to the extent that the additional insured is held liable for your or your agent's acts or omissions arising out of and in the course of operations performed for the additional insured."

The Design-Build Team shall maintain all legally required insurance coverage, including without limitation, worker's compensation and vehicle liability, in the amounts required by law. Providing and maintaining adequate insurance coverage is a material obligation of the Design-Build Team and is of the essence of this contract. All such insurance shall meet all laws of the State of North Carolina. Such insurance coverage shall be obtained from companies that are authorized to provide such coverage and that are authorized by the Commissioner of Insurance to do business in North Carolina. The Design-Build Team shall at all times comply with the terms of such insurance policies.

Upon execution of the contract, provide evidence of the above insurance requirements to the Engineer.

PLANT AND PEST QUARANTINES**(Imported Fire Ant, Gypsy Moth, Witchweed, And Other Noxious Weeds)**

(03-18-03)

DB1 G130

Within Quarantined Area

This project may be within a county regulated for plant and/or pests. If the project or any part of the Design-Build Team's operations is located within a quarantined area, thoroughly clean all equipment prior to moving out of the quarantined area. Comply with federal/state regulations by obtaining a certificate or limited permit for any regulated article moving from the quarantined area.

Originating in a Quarantined County

Obtain a certificate or limited permit issued by the N.C. Department of Agriculture/United States Department of Agriculture. Have the certificate or limited permit accompany the article when it arrives at the project site.

Contact

Contact the N.C. Department of Agriculture/United States Department of Agriculture at 1-800-206-9333, 919-733-6932, or <http://www.ncagr.com/plantind/> to determine those specific project sites located in the quarantined area or for any regulated article used on this project originating in a quarantined county.

Regulated Articles Include

1. Soil, sand, gravel, compost, peat, humus, muck, and decomposed manure, separately or with other articles. This includes movement of articles listed above that may be associated with cut/waste, ditch pulling, and shoulder cutting.
2. Plants with roots including grass sod.
3. Plant crowns and roots.
4. Bulbs, corms, rhizomes, and tubers of ornamental plants.
5. Hay, straw, fodder, and plant litter of any kind.
6. Clearing and grubbing debris.
7. Used agricultural cultivating and harvesting equipment.
8. Used earth-moving equipment.
9. Any other products, articles, or means of conveyance, of any character, if determined by an inspector to present a hazard of spreading imported fire ant, gypsy moth, witchweed or other noxious weeds.

CONTRACTOR CLAIM SUBMITTAL FORM:

(09-16-08)

DB1 G140

If the Design-Build Team elects to file a written claim or requests an extension of contract time, it shall be submitted on the *Contractor Claim Submittal Form (CCSF)* available through the Construction Unit or

http://ncdot.org/doh/operations/dp_chief_eng/constructionunit/formsmanuals/.

GIFTS FROM VENDORS AND CONTRACTORS:

(12-15-09)

DB1 G152

By Executive Order 24, issued by Governor Perdue, and *N.C. G.S. § 133-32*, it is unlawful for any vendor or contractor (i.e. architect, bidder, contractor, construction manager, design professional, engineer, landlord, offeror, seller, subcontractor, supplier, or vendor), to make gifts or to give favors to any State employee of the Governor's Cabinet Agencies (i.e. Administration, Commerce, Correction, Crime Control and Public Safety, Cultural Resources, Environment and Natural Resources, Health and Human Services, Juvenile Justice and Delinquency Prevention, Revenue, Transportation, and the Office of the Governor). This prohibition covers those vendors and contractors who:

- (1) have a contract with a governmental agency; or
- (2) have performed under such a contract within the past year; or
- (3) anticipate bidding on such a contract in the future.

For additional information regarding the specific requirements and exemptions, vendors and contractors are encouraged to review Executive Order 24 and *G.S. § 133-32*.

Executive Order 24 also encouraged and invited other State Agencies to implement the requirements and prohibitions of the Executive Order to their agencies. Vendors and contractors should contact other State Agencies to determine if those agencies have adopted Executive Order 24.

EMBANKMENTS

(5-16-06) (Rev 10-19-10)

DB2 R18

Revise the 2006 *Standard Specifications for Roads and Structures* as follows:

Page 2-22, Article 235-3 MATERIALS, amend as follows:

Add the following as the second sentence of the first paragraph:

Do not use material meeting the requirements of AASHTO M145 for soil classification A-2-5 and A-5 with a plasticity index (PI) of less than 8 within 12" of the subgrade.

Add the following as the second sentence of the second paragraph:

Aerate and dry material containing moisture content in excess of what is required to achieve embankment stability and specified density.

Page 2-22, Subarticle 235-4(B) Embankment Formation, add the following:

- (16) Do not place rock or broken pavement in embankment areas where piles or drilled shaft foundations are to be constructed. This shall include but not be limited to piles and foundations for structures, metal signal poles, overhead sign structures, and high mount lighting.

AGGREGATE SUBGRADE

(09-18-07) (Rev 03-16-10)

DB2 R35

Description

Construct aggregate subgrades in accordance with the contract or as directed by the Engineer. Undercut as needed in cut areas. Install fabric for soil stabilization and place Class IV Subgrade Stabilization at locations shown on the plans.

Materials

Refer to Division 10 of the 2006 *Standard Specifications for Roads and Structures*.

Item	Section
Select Material, Class IV	1016
Fabric for Soil Stabilization, Type 4	1056

Use Class IV Select Material for Class IV Subgrade Stabilization. If Class IV Subgrade Stabilization does not meet the requirements of Article 1010-2 of the 2006 *Standard Specifications for Roads and Structures*, the Engineer may consider the material reasonably acceptable in accordance with Article 105-3 of the 2006 *Standard Specifications for Roads and Structures*.

Construction Methods

When shallow undercut is required to construct aggregate subgrades, undercut 6 to 24 inches as shown on the plans or as directed by the Engineer. Perform undercut excavation in accordance with Section 225 of the 2006 *Standard Specifications for Roads and Structures*. Install fabric for soil stabilization in accordance with Article 270-3 of the 2006 *Standard Specifications for Roads and Structures*. Place Class IV Subgrade Stabilization (standard size no. ABC) by end dumping ABC on the fabric. Do not operate heavy equipment on the fabric until it is covered with Class IV Subgrade Stabilization. Compact ABC to 92% of AASHTO T180 as modified by the Department or to the highest density that can be reasonably obtained.

Maintain Class IV Subgrade Stabilization in an acceptable condition and minimize the use of heavy equipment on ABC in order to avoid damaging aggregate subgrades. Provide and maintain drainage ditches and drains as required to prevent entrapping water in aggregate subgrades.

FLOWABLE FILL

(08-21-07)

DB3 R30

Description

This work consists of all work necessary to place flowable fill in accordance with these provisions, the plans developed by the Design-Build Team and as directed.

Materials

Provide flowable fill material in accordance with Article 340-2 of the 2006 *Standard Specifications for Roads and Structures*.

Construction Methods

Discharge flowable fill material directly from the truck into the space to be filled, or by other approved methods. The mix may be placed full depth or in lifts as site conditions dictate. The Design-Build Team shall provide a method to plug the ends of the existing pipe in order to contain the flowable fill.

BRIDGE APPROACH FILLS

(10-19-10)

DB4 R01

Description

Construct bridge approach fills in accordance with the contract. Bridge approach fills include bridge approach fills for sub regional tier bridges and reinforced bridge approach fills. Geotextiles include engineering fabrics and geomembranes.

Materials

Refer to Division 10 of the *Standard Specifications*:

Item	Section
Portland Cement Concrete, Class B	1000
Select Material	1016
Subsurface Drainage Materials	1044
Engineering Fabrics	1056

Use Class III or V Select Material for reinforced approach fills and only Class V Select Material (standard size no. 78M stone) for bridge approach fills for sub regional tier bridges. Provide polyvinyl chloride (PVC) plastic drainage pipes, fittings and outlet pipes for subsurface drainage materials for all bridge approach fills. For bridge approach fills for sub regional tier bridges, use Type 1 Engineering Fabric for filter fabric to encase no. 78M stone. For reinforced bridge approach fills, use Type 5 Engineering Fabric for woven fabrics and Type 2 Engineering Fabric and no. 78M stone for drains.

Load, transport, unload and store geomembranes such that they are kept clean and free of damage. Geomembranes with defects, flaws, deterioration or damage will be rejected. Do not unwrap geomembranes until just before installation and do not leave geomembranes exposed for more than 7 days before covering geomembranes with woven fabrics.

Use either polyvinyl chloride (PVC), high density polyethylene (HDPE) or linear low density polyethylene (LLDPE) geomembranes. For PVC geomembranes, provide grade PVC30 geomembranes meeting the requirements of ASTM D7176. For HDPE and LLDPE

geomembranes, use geomembranes with a nominal thickness of 30 mils meeting the requirements of Geosynthetic Research Institute Standard Specifications GM13 or GM17, respectively.

Construction Methods

Excavate as necessary for bridge approach fills in accordance with the contract. Notify the Engineer when foundation excavation is complete. Do not place geomembranes or filter fabrics until obtaining approval from the Department of the excavation depth and foundation material.

Attach geomembranes or filter fabrics to back of end bent caps and wing walls with adhesives, tapes or other approved methods. Use wire staples as needed to hold filter fabrics in place until covered. Overlap adjacent fabrics a minimum of 18" such that overlaps are parallel to the roadway centerline. Glue or weld geomembrane seams to prevent leakage. Contact the Engineer when existing or future structures such as foundations, pavements, pipes, inlets or utilities will interfere with geotextiles.

For reinforced bridge approach fills, place woven fabrics within 2" of locations shown on the plans and in slight tension free of kinks, folds, wrinkles or creases. Place first layer of woven fabric directly on geomembranes with no void or material in between. Install woven fabrics with the machine direction (MD) parallel to the roadway centerline. The MD is the direction of the length or long dimension of the roll. Do not splice or overlap woven fabrics in the MD such that splices or overlaps are perpendicular to the roadway centerline. Install woven fabrics with the orientation, dimensions and number of layers shown on the plans. Wrap woven fabrics as shown on the plans or as directed by the Engineer.

For reinforced bridge approach fills, construct 1 ft by 1 ft drains consisting of 4" diameter perforated PVC pipes surrounded by no. 78M stone wrapped in type 2 fabric. For bridge approach fills for sub regional tier bridges, install 4" diameter perforated PVC drainage pipes as shown on the plans.

Firmly connect PVC pipes together as needed. Connect perforated pipes to outlet pipes near the back faces of wing walls. Provide drains with positive drainage towards outlets. Place pipe sleeves in or under wing walls for outlet pipes such that positive drainage is maintained. Use sleeves of sufficient strength to withstand wing wall loads.

Place select material in 8 to 10 inch thick lifts. Compact Class III Select Material in accordance with Subarticle 235-4(C) of the *Standard Specifications*. Do not displace or damage fabrics or drains when placing and compacting select material. End dumping directly on fabrics and drains is not permitted. Do not operate heavy equipment on woven fabrics or drains until they are covered with at least 8" of select material. Replace any damaged fabrics and drains to the satisfaction of the Engineer.

Use only hand operated compaction equipment for bridge approach fills for sub regional tier bridges and within 3 ft of end bent cap back or wing walls for reinforced bridge approach fills. At a distance greater than 3 ft for reinforced bridge approach fills, compact select material with

at least 4 passes of an 8 – 10 ton vibratory roller. Smooth wheeled or rubber tired rollers are also acceptable for compacting select material. Do not use sheepsfoot, grid rollers or other types of compaction equipment with feet.

Use solvent cement for connecting outlet pipes and fittings such as wyes, tees and elbows. Provide connectors for outlet pipes and fittings that are watertight and suitable for gravity flow conditions. All open ends of outlet pipes shall be covered with rodent screens.

Connect drains to concrete pads or existing drainage structures at ends of outlet pipes as directed by the Engineer. Construct concrete pads and provide an Ordinary Surface Finish in accordance with Subarticle 825-6(B) of the *Standard Specifications*.

FINE GRADING SUBGRADE, SHOULDERS AND DITCHES

(07-21-09)

DB5 R001

Revise the 2006 *Standard Specifications for Roads and Structures* as follows:

Page 5-1, Article 500-1 Description, replace the first sentence with the following:

Perform the work covered by this section including but not limited to preparing, grading, shaping, manipulating moisture content, and compacting either an unstabilized or stabilized roadbed to a condition suitable for placement of base course, pavement, and shoulders.

Page 5-1, Subarticle 500-2(A) General, insert the following as the fifth paragraph:

Control the moisture content of the material by drying or adding water.

AGGREGATE BASE COURSE

(12-19-06)

DB5 R03

Revise the 2006 *Standard Specifications for Roads and Structures* as follows:

Page 5-11, Article 520-5 Hauling and Placing Aggregate Base Material, 6th paragraph, replace the first sentence with the following:

Base course that is in place on November 15 shall have been covered with a subsequent layer of pavement structure or with a sand seal. Base course that has been placed between November 16 and March 15 inclusive shall be covered within 7 calendar days with a subsequent layer of pavement structure or with a sand seal.

PREPARATION OF SUBGRADE AND BASE

(01-16-96)

DB5 R05

On mainline portions and ramps of this project, prepare the subgrade and base beneath the pavement structure in accordance with the applicable sections of the 2006 *Standard Specifications for Roads and Structures* except use an automatically controlled fine grading machine utilizing string lines, laser controls, or other approved methods to produce final

subgrade and base surfaces meeting the lines, grades, and cross sections required by the plans or established by the Engineer.

AGGREGATE FOR SOIL-CEMENT BASE

(07-18-06)

DB5 R15

Revise the 2006 *Standard Specifications for Roads and Structures* as follows:

Page 5-27, Article 542-1. Delete the first sentence and substitute the following:

The work covered by this section consists of constructing and curing a soil-cement base by treating the subgrade, existing subbase, or existing base, or any combination of these materials, by pulverizing, adding portland cement, adding aggregate when required, mixing, wetting, and compacting the mixture to the required density.

Page 5-27, Article 542-2. Add the following:

Item	Section
Aggregate, Std. Size ABC	1005

Page 5-29, Article 542-7. Add the following after the first paragraph:

Prior to spreading cement, aggregate shall be spread at the rate shown in the plans.

ASPHALT PAVEMENTS - SUPERPAVE

(07-18-06)(Rev 04-20-10)

DB6 R01

Revise the 2006 *Standard Specifications* as follows:

Page 6-2, Article 600-9 Measurement and Payment, delete the second paragraph.

Page 6-12, Subarticle 609-5(C)2, Required Sampling and Testing Frequencies, first partial paragraph at the top of the page, delete last sentence and add the following:

If the Engineer allows the mix to remain in place, payment will be made in accordance with Article 105-3.

Page 6-12, Subarticle 609-5(C)2, QUALITY CONTROL MINIMUM SAMPLING AND TESTING SCHEDULE

First paragraph, delete and replace with the following.

Sample and test the completed mixture from each mix design per plant per year at the following minimum frequency during mix production:

Second paragraph, delete the fourth sentence, and replace with the following

When daily production of each mix design exceeds 100 tons and a regularly scheduled full test series random sample location for that mix design does not occur during that day's production, perform at least one partial test series consisting of Items A and B in the schedule below.

Page 6-12, Subarticle 609-5(C)2(c) Maximum Specific Gravity, add after (AASHTO T 209):

or ASTM D 2041

Page 6-13, last line and on page and Page 6-14, Subarticle 609-5(C)(2)(e) Retained Tensile Strength (TSR), add a heading before the first paragraph as follows:

- (i) Option 1

Insert the following immediately after the first paragraph:

- (ii) Option 2

Mix sampled from truck at plant with one set of specimens prepared by the Contractor and then tested jointly by QA and QC at a mutually agreed upon lab site within the first 7 calendar days after beginning production of each new mix design.

Second paragraph, delete and replace with the following:

Test all TSR specimens required by either option noted above on either a recording test press or a test press that maintains the peak load reading after the specimen has broken.

Subarticle 609-5(C)(3) Control Charts, delete the second sentence of the first paragraph and replace with the following:

For mix incorporated into the project, record full test series data from all regularly scheduled random samples or directed samples that replace regularly scheduled random samples, on control charts the same day the test results are obtained.

Page 6-15, Subarticle 609-5(C)(3) Control Charts, first paragraph on this page, delete the last sentence and substitute the following:

Denote the moving average control limits with a dash green line and the individual test limits with a dash red line.

Subarticle 609-5(C)(3)(a), (b) and (c), replace (a) (b) and (c) with the following:

- (a) A change in the binder percentage, aggregate blend, or G_{mm} is made on the JMF, or,

- (b) When the Contractor elects to stop or is required to stop production after one or two moving average values, respectively, fall outside the moving average limits as outlined in subarticle 609-5(C)6 or,
- (c) If failure to stop production after two consecutive moving averages exceed the moving average limits occurs, but production does stop at a subsequent time, re-establish a new moving average beginning at the actual production stop point.

Subarticle 609-5(C)(4) Control Limits, replace the first paragraph and the CONTROL LIMITS Table on page 6-16 with the following.

The following are established as control limits for mix production. Apply the individual limits to the individual test results. Control limits for the moving average limits are based on a moving average of the last 4 data points. Apply all control limits to the applicable target source.

CONTROL LIMITS

Mix Control Criteria	Target Source	Moving Average Limit	Individual Limit
2.36 mm Sieve	JMF	±4.0 %	±8.0 %
0.075mm Sieve	JMF	±1.5 %	±2.5 %
Binder Content	JMF	±0.3 %	±0.7 %
VTM @ N _{des}	JMF	±1.0 %	±2.0 %
VMA @ N _{des}	Min. Spec. Limit	Min Spec. Limit	-1.0%
P _{0.075} / P _{be} Ratio	1.0	±0.4	±0.8
% G _{mm} @ N _{ini}	Max. Spec. Limit	N/A	+2.0%
TSR	Min. Spec. Limit	N/A	- 15%

Page 6-16, Subarticle 609-5(C)(5) Warning Bands, delete this subarticle in its entirety.

Pages 6-16 through 6-19, Subarticle 609-5(C)(6), delete the word "warning" and substitute the words "moving average".

Page 6-16, Subarticle 609-5(C)(6) Corrective Actions, first paragraph, first sentence, delete and replace with the following:

Immediately notify the Engineer when moving averages exceed the moving average limits.

Page 6-17, third full paragraph, delete and replace with the following:

Failure to stop production when required due to an individual mix test not meeting the specified requirements will subject all mix from the stop point tonnage to the point when the next individual test is back on or within the moving average limits, or to the tonnage

point when production is actually stopped, whichever occurs first, to being considered unacceptable.

Sixth full paragraph, delete the first, second, and third sentence and replace with the following:

Immediately notify the Engineer when any moving average value exceeds the moving average limit. If two consecutive moving average values for any one of the mix control criteria fall outside the moving average limits, cease production of that mix, immediately notify the Engineer of the stoppage, and make adjustments. The Contractor may elect to stop production after only one moving average value falls outside the moving average limits.

Page 6-18, Subarticle 609-5(C)(6) Corrective Actions second full paragraph, delete and replace with the following:

If the process adjustment improves the property in question such that the moving average after four additional tests is on or within the moving average limits, the Contractor may continue production with no reduction in payment

Page 6-18, delete the third and fourth full paragraphs, including the Table for Payment for Mix Produced in the Warning Bands and substitute the following:

If the adjustment does not improve the property in question such that the moving average after four additional individual tests is outside the moving average limits, the mix will be evaluated for acceptance in accordance with Article 105-3. Reduced payment for or removal of the mix in question will be applied starting from the plant sample tonnage at the stop point to the sample tonnage when the moving average is on or within the moving average limits. In addition, any mix that is obviously unacceptable will be rejected for use in the work.

Page 6-19, First paragraph, delete and replace with the following:

Failure to stop production and make adjustments when required due to two consecutive moving average values falling outside the moving average limits will subject all mix produced from the stop point tonnage to the tonnage point when the moving average is back on or within the moving average limits or to the tonnage point when production is actually stopped, whichever occurs first, to being considered unacceptable. Remove this material and replace with materials that comply with the Specifications at no additional costs to the Department, unless otherwise approved. Payment will be made for the actual quantities of materials required to replace the removed quantities, not to exceed the original amounts.

Page 6-20, Subarticle 609-5(D)(1) General, delete the third full paragraph, and replace with the following:

Perform the sampling and testing at the minimum test frequencies as specified above. Should the density testing frequency fail to meet the minimum frequency as specified above, all mix without the required density test representation will be considered unsatisfactory. If the Engineer allows the mix to remain in place, payment will be made in accordance with Article 105-3.

Page 6-22, Subarticle 609-5(D)(4) Nuclear Gauge Density Procedures, third paragraph, insert the following as the second sentence:

Determine the Daily Standard Count in the presence of the QA Roadway Technician or QA Nuclear Gauge Technician on days when a control strip is being placed.

Page 6-23, Subarticle 609-5(D)(5) Limited Production Procedure, delete the first paragraph including (a), (b), (c) and substitute the following:

Proceed on limited production when, for the same mix type and on the same contract, one of the following conditions occur (except as noted in the first paragraph below).

- (a) Two consecutive failing lots, except on resurfacing*
- (b) Three consecutive failing lots on resurfacing*
- (c) Two consecutive failing nuclear control strips.

* Resurfacing is defined as the first new uniform layer placed on an existing pavement.

Page 6-25, Article 609-6 Quality Assurance, Density Quality Assurance, insert the following items after item (E):

- (F) By retesting Quality Control core samples from control strips (either core or nuclear) at a frequency of 100% of the frequency required of the Contractor;
- (G) By observing the Contractor perform all standard counts of the Quality Control nuclear gauge prior to usage each nuclear density testing day; or
- (H) By any combination of the above

Page 6-28, Subarticle 610-3(A) Mix Design-General, delete the fourth and fifth paragraphs and replace with the following:

Reclaimed Asphalt Pavement (RAP) or Reclaimed Asphalt Shingles (RAS) may be incorporated into asphalt plant mixes in accordance with Article 1012-1 and the following applicable requirements.

Reclaimed asphalt pavement (RAP) may constitute up to 50% of the total material used in recycled mixtures, except for mix Type S 12.5D, Type S 9.5D, and mixtures containing reclaimed asphalt shingle material (RAS). Reclaimed asphalt shingle (RAS)

material may constitute up to 6% by weight of total mixture for any mix. When both RAP and RAS are used, do not use a combined percentage of RAS and RAP greater than 20% by weight of total mixture, unless otherwise approved. When the percent of binder contributed from RAS or a combination of RAS and RAP exceeds 20% but not more than 30% of the total binder in the completed mix, the virgin binder PG grade shall be one grade below (both high and low temperature grade) the binder grade specified in Table 610-2 for the mix type, unless otherwise approved. When the percent of binder contributed from RAS or a combination of RAS and RAP exceeds 30% of the total binder in the completed mix, the Engineer will establish and approve the virgin binder PG grade. Use approved methods to determine if any binder grade adjustments are necessary to achieve the performance grade for the specified mix type.

For Type S 12.5D and Type S 9.5D mixes, the maximum percentage of reclaimed asphalt material is limited to 20% and shall be produced using virgin asphalt binder grade PG 76-22. For all other recycled mix types, the virgin binder PG grade shall be as specified in Table 610-2A for the specified mix type.

When the percentage of RAP is greater than 20% but not more than 30% of the total mixture, use RAP meeting the requirements for processed or fractionated RAP in accordance with the requirements of Section 1012-1.

When the percentage of RAP is greater than 30% of the total mixture, use an approved stockpile of RAP in accordance with Section 1012-1(C). Use approved test methods to determine if any binder grade adjustments are necessary to achieve the performance grade for the specified mix type. The Engineer will establish and approve the virgin asphalt binder grade to be used.

Page 6-34, Subarticle 610-3(C),

Delete Table 610-2 and associated notes. Substitute the following:

Page 6-34, Insert the following immediately after Table 610-2:

**TABLE 610-2A
SUPERPAVE MIX DESIGN CRITERIA**

	Percentage of RAP in Mix		
	Category 1	Category 2	Category 3
Mix Type	% RAP ≤20%	20.1% ≤ %RAP ≤ 30.0%	%RAP > 30.0%
All A and B Level Mixes, I19.0C, B25.0C	PG 64 -22	PG 64 -22	TBD
S9.5C, S12.5C, I19.0D	PG 70 -22	PG 64-22	TBD
S 9.5D and S12.5D	PG 76-22	N/A	N/A

Note:

- (1) Category 1 RAP has been processed to a maximum size of 2 inches.
- (2) Category 2 RAP has been processed to a maximum size of 1 inch by either crushing and or screening to reduce variability in the gradations.
- (3) Category 3 RAP has been processed to a maximum size of 1 inch, fractionating the RAP into 2 or more sized stockpiles

Page 6-35, Table 610-3 delete and replace with the following:

**TABLE 610-3
ASPHALT PLACEMENT- MINIMUM TEMPERATURE REQUIREMENTS**

Asphalt Concrete Mix Type	Minimum Air Temperature	Minimum Surface Temperature
ACBC, Type B 25.0B, C, B 37.5C	35°F	35°F
ACIC, Type I 19.0B, C, D	35°F	35°F
ACSC, Type S 4.75A, SF 9.5A, S 9.5B	40°F	50°F*
ACSC, Type S 9.5C, S 12.5C	45°F	50°F
ACSC, Type S 9.5D, S 12.5D	50°F	50°F

* 35°F if surface is soil or aggregate base for secondary road construction.

Page 6-44, Article 610-8 Spreading and Finishing, third full paragraph, replace the first sentence with the following:

Use the 30 foot minimum length mobile grade reference system or the non-contacting laser or sonar type ski *with at least four referencing stations mounted on the paver at a minimum length of 24 feet* to control the longitudinal profile when placing the initial lanes and all adjacent lanes of all layers, including resurfacing and asphalt in-lays, unless otherwise specified or approved.

Page 6-45, Article 610-8 SPREADING AND FINISHING delete the third paragraph on page 6-45 and replace with the following:

Use a Material Transfer Vehicle (MTV) when placing all asphalt concrete plant mix pavements which require the use of asphalt binder grade PG 76-22 and for all types of OGAFc, unless otherwise approved. Use a MTV for all surface mix regardless of binder grade placed on Interstate facilities. Where required above, utilize the MTV when placing all full width travel lanes, collector lanes, ramps, and loops.

Page 6-50, Article 610-13 Density Acceptance, delete the second paragraph and replace with the following:

As an exception, when the first layer of mix is a surface course and is being placed directly on an unprimed aggregate or soil base, the layer will be included in the "Other" construction category.

Page 6-50, Article 610-13 Density Acceptance, delete the formula and description in the middle of the page and replace with the following:

$$\text{PF} = 100 - 10(D)^{1.465}$$

where:

PF = Pay Factor (computed to 0.1%)
D = the deficiency of the lot average density, not to exceed 2.0%

Page 6-53, Article 620-4 Measurement and Payment:

Sixth paragraph, delete the last sentence.

Seventh paragraph, delete the paragraph and replace with the following:

The adjusted contract unit price will then be applied to the theoretical quantity of asphalt binder authorized for use in the plant mix placed during the partial payment period involved, except that where recycled plant mix is used, the adjusted unit price will be applied only to the theoretical number of tons of additional asphalt binder materials required by the job mix formula.

Page 6-54, Article 620-4 Measurement and Payment, add the following pay item:

Pay Item	Pay Unit
Asphalt Binder for Plant Mix, Grade PG 70-28	Ton

Page 6-59, Article 650-5 CONSTRUCTION REQUIREMENTS delete the second paragraph from the bottom of the page beginning "Use a Material Transfer Vehicle (MTV)..." and replace with the following:

Use a Material Transfer Vehicle (MTV) when placing all asphalt concrete plant mix pavements which require the use of asphalt binder grade PG 76-22 and for all types of OGAFc, unless otherwise approved. Use a MTV for all surface mix regardless of binder grade placed on

Interstate facilities. Where required above, utilize the MTV when placing all full width travel lanes, collector lanes, ramps, and loops.

Page 6-69, Table 660-1 Material Application Rates and Temperatures, add the following:

Type of Coat	Grade of Asphalt	Asphalt Rate gal/yd ²	Application Temperature °F	Aggregate Size	Aggregate Rate lb./sq. yd. Total
Sand Seal	CRS-2 or CRS-2P	0.22-0.30	150-175	Blotting Sand	12-15

Page 6-75, Subarticle 660-9(B), add the following as sub-item (5)

(5) Sand Seal

Place the fully required amount of asphalt material in one application and immediately cover with the seal coat aggregate. Uniformly spread the fully required amount of aggregate in one application and correct all non-uniform areas prior to rolling.

Immediately after the aggregate has been uniformly spread, perform rolling.

When directed, broom excess aggregate material from the surface of the seal coat.

When the sand seal is to be constructed for temporary sealing purposes only and will not be used by traffic, other grades of asphalt material meeting the requirements of Articles 1020-6 and 1020-7 may be used in lieu of the grade of asphalt required by Table 660-1 when approved.

Page 6-76, Article 661-1 Description, add the following as the 2nd paragraph:

Provide and conduct the quality control and required testing for acceptance of the UBWC in accordance with *Quality Management System for Asphalt Pavements (OGAFC, PADL, and Ultra-Thin HMA Version)*, included in the contract.

Page 6-76, Article 661-2 Materials, add the following after Asphalt Binder, Grade 70-28:

Item	Section
Asphalt Binder, Grade 76-22	1020
Reclaimed Asphalt Shingles	1012

Page 6-78, Subarticle 661-2(E), Asphalt Binder For Plant Mix, Grade PG 70-28, rename as ASPHALT BINDER FOR PLANT MIX and add the following as the first paragraph:

Use either PG 70-28 or PG 76-22 binder in the mix design. Where PG 76-22 is being used in the production of Ultra-thin, the grade of asphalt binder to be paid for will be PG 70-28, unless otherwise approved.

Page 6-79, Subarticle 661-2(G), Composition of Mix, add the following as the third sentence of the first paragraph.

The percent of asphalt binder contributed from the RAS shall not exceed 20% of the total binder in the completed mix.

Page 6-80, Article 661-2(G) Composition of Mix, replace Table 661-4 and associated notes with the following:

TABLE 661-4 – MIXTURE DESIGN CRITERIA				
Gradation Design Criteria (% Passing by Weight)				
Standard Sieves		1/2 in. Type A	3/8 in. Type B	1/4 in. Type C
ASTM	mm	(% Passing by Weight)		
¾ inch	19.0	100		
½ inch	12.5	85 - 100	100	
3/8 inch	9.5	60 - 80	85 - 100	100
#4	4.75	28 - 38	28 - 44	40 - 55
#8	2.36	19 - 32	17 - 34	22 - 32
#16	1.18	15 - 23	13 - 23	15 - 25
#30	0.600	10 - 18	8 - 18	10 - 18
#50	0.300	8 - 13	6 - 13	8 - 13
#100	0.150	6 - 10	4 - 10	6 - 10
#200	0.075	4.0 - 7.0	3.0 - 7.0	4.0 - 7.0

Mix Design Criteria			
	1/2 in. Type A	3/8 in. Type B	1/4 in. Type C
Asphalt Content, %	4.6 - 5.6	4.6 - 5.8	5.0 - 5.8
Draindown Test, AASHTO T 305	0.1% max.		
Moisture Sensitivity, AASHTO T 283*	80% min.		
Application Rate, lb/ yd ²	90	70	50
Approximate Application Depth, in.	3/4	5/8	1/2
Asphalt PG Grade, AASHTO M 320	PG 70-28 or PG 76-22	PG 70-28 or PG 76-22	PG 70-28 or PG 76-22

NOTE: *Specimens for T-283 testing are to be compacted using the SUPERPAVE gyratory compactor. The mixtures shall be compacted using 100 gyrations to achieve specimens approximately 95 mm in height. Use mixture and compaction temperatures recommended by the binder supplier.

Page 6-80, Subarticle 661-3(A) Equipment, add the following as the first paragraph:

Use asphalt mixing plants in accordance with Article 610-5 of the *Standard Specifications*.

Page 6-82, Subarticle 661-3(C), Application of Ultra-thin Bonded Wearing Course, delete the first paragraph and add the following as the first and second paragraphs.

Use only one asphalt binder PG grade for the entire project, unless the Engineer gives written approval.

Do not place Ultra-thin Bonded Wearing Course between October 31 and April 1, when the pavement surface temperature is less than 50°F or on a wet pavement. In addition, when PG 76-22 binder is used in the JMF, place the wearing course only when the road pavement surface temperature is 60°F or higher and the air temperature in the shade away from artificial heat is 60°F or higher.

Page 10-40, Subarticle 1012-1(A), add the following at the end of the last paragraph, last sentence:

or ultra-thin bonded wearing course.

Page 10-41, Table 1012-1, delete the entries for OGAF C and add new entries for OGAF C and a row for UBWC with entries:

Mix Type	Coarse Aggregate Angularity ^(b) ASTM D5821	Fine Aggregate Angularity % Minimum AASHTO T304 Method A	Sand Equivalent % Minimum AASHTO T176	Flat & Elongated 5:1 Ratio % Maximum ASTM D4791 Section 8.4
S 9.5 D	100/100	45	50	10
OGAF C	100/100	N/A	N/A	10
UBWC	100/85	40	45	10

Delete Note (c) under the Table 1012-1 and replace with the following:

(c) Does not apply to Mix Types SF 9.5A and S 9.5B.

Page 10-42, Subarticle 1012-1(B)(6), add as the last sentence:

The percentage loss for aggregate used in UBWC shall be no more than 35%.

Page 10-43, Subarticle 1012-1(F): Reclaimed Asphalt Shingle Material (RAS), insert the following immediately following the first paragraph:

(1) Mix Design RAS

Incorporate RAS from stockpiles that have been tested for uniformity of gradation and binder content prior to use in an asphalt mix design.

(2) Mix Production RAS

New Source RAS is defined as acceptable material which was not included in the stockpile when samples were taken for mix design purposes. Process new source RAS so that all materials will pass a 1/2" sieve prior to introduction into the plant mixer unit.

After a stockpile of processed RAS has been sampled and mix designs made from these samples, do not add new source RAS to the original stockpile without prior field testing to insure gradation and binder uniformity. Sample and test new source RAS before blending with the existing stockpile.

Store new source RAS in a separate stockpile until the material can be sampled and tested for comparison with the original recycled mix design data. New source RAS may also be placed against the existing stockpile in a linear manner provided it is sampled for mix design conformity prior to its use in the recycled mix.

RAS contamination including but not limited to excessive dirt, debris, clean stone, concrete will not be allowed.

Field approval of new source RAS will be based on the table below and volumetric mix properties on the mix with the new source RAS included. Provided these tolerances are met, volumetric properties of the new mix will then be performed. If all volumetric mix properties meet the mix design criteria for that mix type, the new source RAS may continue to be used.

If the gradation, binder content, or any of the volumetric mix properties are not within the allowable tolerances of the table below, do not use the new source RAS unless approved by the Engineer. The Contractor may elect to either not use the stockpile, to request an adjustment to the JMF, or to redesign the mix.

NEW SOURCE RAS GRADATION and BINDER TOLERANCES
(Apply Tolerances to Mix Design Data)

0-6% RAS	
P _b %	±1.6%
Sieve Size (mm)	Tolerance
9.5	±1
4.75	±5
2.36	±4
1.18	±4
0.300	±4
0.150	±4
0.075	±2.0

Page 10-43 through 10-45, Subarticle 1012-1(G), delete this in its entirety and replace with the following:

(G) Reclaimed Asphalt Pavement (RAP)

(1) Mix Design RAP

Incorporate RAP from stockpiles or other sources that have been tested for uniformity of gradation and binder content prior to use in an asphalt mix design. Use reclaimed asphalt pavement that meets all requirements specified for *one* of the following *two* classifications.

(a) Millings

Existing reclaimed asphalt pavement (RAP) that is removed from its original location by a milling process as specified in Section 607. Millings should be such that it has a uniform gradation and binder content and all materials will pass a 2" sieve prior to introduction into the plant mixer unit.

(b) Processed RAP

RAP that is processed in some manner (possibly by crushing and/or use of a blending method) to produce a uniform gradation and binder content in the RAP prior to use in a recycled mix. Process RAP so that all materials have a uniform gradation and binder content and will pass a 1" sieve prior to introduction into the plant mixer unit.

(c) Fractionated RAP

Fractionated RAP is defined as having two or more RAP stockpiles, where the RAP is divided into coarse and fine fractions. Grade RAP so that all materials will pass a 1" sieve. The coarse RAP stockpile shall only contain material retained on a 3/8" screen, unless otherwise approved. The fine RAP stockpile shall only contain material passing the 3/8" screen, unless otherwise approved. The Engineer may allow the Contractor to use an alternate to the 3/8" screen to fractionate the RAP. The maximum percentages of fractionated RAP may be comprised of coarse, fine, or the combination of both. Utilize a separate cold feed bin for each stockpile of fractionated RAP used.

(d) Approved Stockpiled RAP

Approved Stockpiled RAP is defined as fractionated RAP which has been isolated and tested for asphalt content, gradation, and asphalt binder characteristics with the intent to be used in mix designs with

greater than 30% RAP materials. Fractionate the RAP in accordance with Section 1012-1(G)(c). Utilize a separate cold feed bin for each approved stockpile of RAP used.

Perform extraction tests at a rate of 1 per 1000 tons of RAP, with a minimum of 5 tests per stockpile to determine the asphalt content and gradation. Separate stockpiles of RAP material by fine and coarse fractions. Erect and maintain a sign satisfactory to the Engineer on each stockpile to identify the material. Assure that no deleterious material is allowed in any stockpile. The Engineer may reject by visual inspection any stockpiles that are not kept clean, separated, and free of foreign materials.

Submit requests for RAP stockpile approval to the Engineer with the following information at the time of the request:

- (1) Approximate tons of materials in stockpile
- (2) Name or Identification number for the stockpile
- (3) Asphalt binder content and gradation test results
- (4) Asphalt characteristics of the Stockpile.

For the Stockpiled RAP to be considered for approval, the gradation and asphalt content shall be uniform. Individual test results, when compared to the target, will be accepted if within the tolerances listed below:

APPROVED STOCKPILED RAP GRADATION and BINDER TOLERANCES
(Apply Tolerances to Mix Design Data)

P_b %	$\pm 0.3\%$
Sieve Size (mm)	Percent Passing
25.0	$\pm 5\%$
19.0	$\pm 5\%$
12.5	$\pm 5\%$
9.5	$\pm 5\%$
4.75	$\pm 5\%$
2.36	$\pm 4\%$
1.18	$\pm 4\%$
0.300	$\pm 4\%$
0.150	$\pm 4\%$
0.075	$\pm 1.5\%$

Note: If more than 20% of the individual sieves are out of the gradation tolerances, or if more than 20% of the asphalt binder content test results fall outside the appropriate tolerances, the RAP shall not be used in HMA unless the RAP representing the failing tests is removed from the stockpile.

Do not add additional material to any approved RAP stockpile, unless otherwise approved by the Engineer.

Maintain at the plant site a record system for all approved RAP stockpiles. Include at a minimum the following: Stockpile identification and a sketch of all stockpile areas at the plant site; all RAP test results (including asphalt content, gradation, and asphalt binder characteristics).

(2) Mix Production RAP

During mix production, use RAP that meets the criteria for one of the following categories:

(a) Mix Design RAP

RAP contained in the mix design stockpiles as described above may be used in all applicable JMFs. These stockpiles have been pretested; however, they are subject to required QC/QA testing in accordance with Subarticle 609-5(C)(2).

(b) New Source RAP

New Source RAP is defined as any acceptable material that was not included in the stockpile or other source when samples were taken for mix design purposes. Process new source RAP so that all materials have a uniform gradation and binder content and will pass a 2" sieve prior to introduction into the plant mixer unit.

After a stockpile of millings, processed RAP, or fractionated RAP has been sampled and mix designs made from these samples, do not add new source RAP to the original stockpile without prior field testing to insure gradation and binder uniformity. Sample and test new source RAP before blending with the existing stockpile.

Store new source RAP in a separate stockpile until the material can be sampled and tested for comparison with the original recycled mix design data. New source RAP may also be placed against the existing stockpile in a linear manner provided it is sampled for mix design conformity prior to its use in the recycled mix.

Unprocessed RAP is asphalt material that was not milled and/or has not been processed to obtain a uniform gradation and binder content and is not representative of the RAP used during the applicable mix design. Unprocessed RAP shall not be incorporated into any JMFs

prior to processing. Different sources of unprocessed RAP may be stockpiled together provided it is generally free of contamination and will be processed prior to use in a recycled mix. RAP contamination in the form of excessive dirt, debris, clean stone, concrete, etc. will not be allowed. Incidental amounts of dirt, concrete, and clean stone may be acceptable. Unprocessed RAP may be processed and then classified as a new source RAP as described above.

Field approval of new source RAP will be based on Table 1012-2 below and volumetric mix properties on the mix with the new source RAP included. Provided the Table 1012-2 tolerances are met, volumetric properties of the new mix will then be performed. If all volumetric mix properties meet the mix design criteria for that mix type, the new source RAP may continue to be used.

If the gradation, binder content, or any of the volumetric mix properties are not within the allowable tolerances of Table 1012-2, do not use the new source RAP unless approved by the Engineer. The Contractor may elect to either not use the stockpile, to request an adjustment to the JMF, or to redesign the mix.

TABLE 1012-2									
NEW SOURCE RAP GRADATION and BINDER TOLERANCES									
(Apply Tolerances to Mix Design Data)									
Mix Type	0-20% RAP			20 ⁺ -30 % RAP			30 ⁺ % RAP		
Sieve (mm)	Base	Inter.	Surf.	Base	Inter.	Surf.	Base	Inter.	Surf.
P _b %	± 0.7%			± 0.4%			± 0.3%		
25.0	±10	-	-	±7	-	-	±5	-	-
19.0	±10	±10	-	±7	±7	-	±5	±5	-
12.5	-	±10	±10	-	±7	±7	-	±5	±5
9.5	-	-	±10	-	-	±7	-	-	±5
4.75	±10	-	±10	±7	-	±7	±5	-	±5
2.36	±8	±8	±8	±5	±5	±5	±4	±4	±4
1.18	±8	±8	±8	±5	±5	±5	±4	±4	±4
0.300	±8	±8	±8	±5	±5	±5	±4	±4	±4
0.150	-	-	±8	-	-	±5	-	-	±4
0.075	±4	±4	±4	±2	±2	±2	±1.5	±1.5	±1.5

ASPHALT PAVER - FIXED AND MOBILE STRING LINE

(07-21-09)

DB6 R07

The Design Build Team's attention is directed to Article 610-8 of the 2006 *Standard Specifications for Roads and Structures* dealing with automatically controlled screeds on the asphalt pavement spreaders.

A mobile string line consisting of a 30 to 40 foot long ski is required for the widening and resurfacing on this project. A fixed string line is required for the new pavement construction on this project.

ASPHALT BINDER CONTENT OF ASPHALT PLANT MIXES

(10-06-05)

DB6 R15

The approximate asphalt binder content of the asphalt concrete plant mixtures used on this project will be as follows:

Asphalt Concrete Base Course	Type B 25.0_	4.3%
Asphalt Concrete Intermediate Course	Type I 19.0_	4.7%
Asphalt Concrete Surface Course	Type S 4.75_	7.0%
Asphalt Concrete Surface Course	Type SF 9.5_	6.5%
Asphalt Concrete Surface Course	Type S 9.5_	6.0%
Asphalt Concrete Surface Course	Type S 12.5_	5.5%

The actual asphalt binder content will be established during construction by the Engineer within the limits established in the 2006 *Standard Specifications* or Project Special Provisions.

FINAL SURFACE TESTING - ASPHALT PAVEMENTS

(07-15-08)

DB6 R45

On portions of this project where the typical section requires two or more layers of new pavement, perform acceptance testing of the longitudinal profile of the finished pavement surface in accordance with these provisions using a North Carolina Hearne Straightedge (Model No. 1). Furnish and operate the straightedge to determine and record the longitudinal profile of the pavement on a continuous graph. Final surface testing is an integral part of the paving operation and is subject to observation and inspection by the Engineer as deemed necessary.

Push the straightedge manually over the pavement at a speed not exceeding 2 miles per hour (3 kilometers per hour). For all lanes, take profiles in the right wheel path approximately 3 ft (1 m) from the right edge of pavement in the same direction as the paving operation, unless otherwise approved due to traffic control or safety considerations. As an exception, lanes adjacent to curb and gutter, expressway gutter, or shoulder berm gutter may be tested in the left wheel path. Make one pass of the straightedge in each full width travel lane. The full lane width should be comparable in ride quality to the area evaluated with the Hearne Straightedge. If deviations exist at other locations across the lane width, utilize a 10 foot (3 meters) non-mobile straightedge or the Hearne Straightedge to evaluate which areas may require corrective action. Take profiles as soon as practical after the pavement has been rolled and compacted but in no event later than 24 hours following placement of the pavement, unless otherwise authorized by

the Engineer. Take profiles over the entire length of final surface travel lane pavement exclusive of -Y- line travel lanes less than or equal to 1000 feet (300 meters) in length, ramps less than or equal to 1000 feet (300 meters) in length, turn lanes less than or equal to 1000 feet (300 meters) in length, structures, approach slabs, paved shoulders, loops, and tapers or other irregular shaped areas of pavement, unless otherwise approved by the Engineer. Test in accordance with this provision all mainline travel lanes, full width acceleration or deceleration lanes, -Y- line travel lanes greater than 1000 feet (300 meters) in length, ramps, full width turn lanes greater than 1000 feet (300 meters) in length, and collector lanes.

At the beginning and end of each day's testing operations, and at such other times as determined necessary by the Engineer, operate the straightedge over a calibration strip so that the Engineer can verify correct operation of the straightedge. The calibration strip must be a 100 ft (30 m) section of pavement that is reasonably level and smooth. Submit each day's calibration graphs with that day's test section graphs to the Engineer. Calibrate the straightedge in accordance with the current NCDOT procedure titled "North Carolina Hearne Straightedge - Calibration and Determination of Cumulative Straightedge Index". Copies of this procedure may be obtained from the Department's Pavement Construction Section.

Plot the straightedge graph at a horizontal scale of approximately 25 ft per inch (3 m per cm) with the vertical scale plotted at a true scale. Record station numbers and references (bridges, approach slabs, culverts, etc.) on the graphs, and distances between references/stations must not exceed 100 ft (30 m). Have the operator record the Date, Project No., Lane Location, Wheel Path Location, Type Mix, and Operator's Name on the graph.

Upon completion of each day's testing, evaluate the graph, calculate the Cumulative Straightedge Index (CSI), and determine which lots, if any, require corrective action. Document the evaluation of each lot on a QA/QC-7 form. Submit the graphs along with the completed QA/QC-7 forms to the Engineer, within 24 hours after profiles are completed, for verification of the results. The Engineer will furnish results of their acceptance evaluation to the Design-Build Team within 48 hours of receiving the graphs. In the event of discrepancies, the Engineer's evaluation of the graphs will prevail for acceptance purposes. The Engineer will retain all graphs and forms.

Use blanking bands of 0.2 inches, 0.3 inches, and 0.4 inches (5 mm, 7.5 mm, and 10 mm) to evaluate the graph for acceptance. The 0.2 inch and 0.3 inch (5 mm and 7.5 mm) blanking bands are used to determine the Straightedge Index (SEI), which is a number that indicates the deviations that exceed each of the 0.2 inch and 0.3 inch (5 mm and 7.5 mm) bands within a 100 ft (30 m) test section. The Cumulative Straightedge Index (CSI) is a number representing the total of the SEIs for one lot, which consist of not more than 25 consecutive test sections. In addition, the 0.4 inch (10 mm) blanking band is used to further evaluate deviations on an individual basis. The Cumulative Straightedge Index (CSI) will be determined by the Engineer in accordance with the current procedure titled "North Carolina Hearne Straightedge - Calibration and Determination of Cumulative Straightedge Index".

The pavement will be accepted for surface smoothness on a lot by lot basis. A test section represents pavement one travel lane wide not more than 100 ft (30 m) in length. A lot will

consist of 25 consecutive test sections, except that separate lots will be established for each travel lane, unless otherwise approved by the Engineer. In addition, full width acceleration or deceleration lanes, ramps, turn lanes, and collector lanes, will be evaluated as separate lots.

If during the evaluation of the graphs, 5 lots (mainline travel lanes and full width -Y- line travel lanes greater than 300 feet in length only) require corrective action, then proceed on limited production for unsatisfactory laydown in accordance with Article 610-12. Proceeding on limited production is based upon the Design-Build Team's initial evaluation of the straightedge test results and must begin immediately upon obtaining those results. Additionally, the Engineer may direct the Design-Build Team to proceed on limited production in accordance with Article 610-12 due to unsatisfactory laydown or workmanship.

Limited production for unsatisfactory laydown is defined as being restricted to the production, placement, compaction, and final surface testing of a sufficient quantity of mix necessary to construct only 2500 feet (750 meter) of pavement at the laydown width. Once this lot is complete, the final surface testing graphs will be evaluated jointly by the Design-Build Team and the Engineer. Remain on limited production until such time as acceptable laydown results are obtained or until three consecutive 2500 foot (750 meter) sections have been attempted without achieving acceptable laydown results. The Engineer will determine if normal production may resume based upon the CSI for the limited production lot and any adjustments to the equipment, placement methods, and/or personnel performing the work. Once on limited production, the Engineer may require the Design-Build Team to evaluate the smoothness of the previous asphalt layer and take appropriate action to reduce and/or eliminate corrective measures on the final surface course. Additionally, the Design-Build Team may be required to demonstrate acceptable laydown techniques off the project limits prior to proceeding on the project.

If the Design-Build Team fails to achieve acceptable laydown results after three consecutive 2500 foot (750 meter) sections have been attempted, cease production of that mix type until such time as the cause of the unsatisfactory laydown results can be determined.

As an exception, the Engineer may grant approval to produce a different mix design of the same mix type if the cause is related to mix problem(s) rather than laydown procedures. If production of a new mix design is allowed, proceed under the limited production procedures detailed above.

After initially proceeding under limited production, the Design-Build Team shall immediately notify the Engineer if any additional lot on the project requires corrective action. The Engineer will determine if limited production procedures are warranted for continued production.

If the Design-Build Team does not operate by the limited production procedures as specified above, the 5 lots, which require corrective action, will be considered unacceptable and may be subject to removal and replacement.

The adjustment schedule for the Cumulative Straightedge Index (CSI) test results per lot is as follows:

Adjustment Schedule for Cumulative Straightedge Index (CSI) (Obtained by adding SE Index of up to 25 consecutive 100 ft. (30m) sections)		
*CSI	ACCEPTANCE CATEGORY	CORRECTIVE ACTION
0-0	Acceptable	None
1-0 or 2-0	Acceptable	None
3-0 or 4-0	Acceptable	None
Any Other Number	Unacceptable	Required

***Either Before or After Corrective Actions**

Correct any deviation that exceeds a 0.3 inch (7.5 mm) blanking band such that the deviation is reduced to 0.2 inches (5 mm) or less.

Corrective actions shall be performed at the Design-Build Team's expense and shall be presented for evaluation and approval by the Engineer prior to proceeding. Any corrective action performed shall not reduce the integrity or durability of the pavement which is to remain in place. Corrective action for deviation repair may consist of overlaying or removing and replacing. Scraping of the pavement with any blade type device will not be allowed as a corrective action. Provide overlays of the same type mix, full roadway width, and to the length and depth established by the Engineer. Tapering of the longitudinal edges of the overlay will not be allowed.

Take corrective actions as specified if the CSI indicates "Required" corrective action. The CSI after corrective action should meet or exceed "Acceptable" requirements.

Where corrective action is required, the test section(s) requiring corrective action will be retested, unless the Engineer directs the retesting of the entire lot.

Test sections and/or lots that are initially tested by the Design-Build Team which indicate excessive deviations such that corrective action is required, may be re-rolled with asphalt rollers while the mix is still warm and in a workable condition, to possibly correct the problem. In this instance, reevaluation of the test section(s) must be completed within 24 hours of pavement placement and these test results will serve as the initial test results.

Areas excluded from testing by the N.C. Hearne Straightedge will be tested by using a non-mobile 10-foot (3 m) straightedge. Assure that the variation of the surface from the testing edge of the straightedge between any two contact points with the surface is not more than 1/8 inch (3 mm). Correct deviations exceeding the allowable tolerance in accordance with the corrective actions specified above, unless the Engineer permits other corrective actions.

Furnish the North Carolina Hearne Straightedge(s) necessary to perform this work. Maintain responsibility for all costs relating to the procurement, handling, and maintenance of these devices. The Department has entered into a license agreement with a manufacturer to fabricate, sell, and distribute the N.C. Hearne Straightedge. The Department's Pavement Construction

Section may be contacted for the name of the current manufacturer and the approximate price of the straightedge.

TYING PROPOSED CONCRETE PAVEMENT TO EXISTING CONCRETE PAVEMENT

(07-01-95)

DB7 R05

Tie proposed concrete pavement on this project to existing concrete pavement in accordance with the detail shown in the plans and the following provision:

1. Drill holes in the existing concrete pavement 1/8" greater than the diameter of the dowel bar. After drilling, blow the hole out with air and allow to dry.
2. Next, place the cement grout or epoxy resin in the back of the dowel hole. The placement of grout can be achieved by using a flexible tube with a long nose that places the material in the back of the dowel hole; the placement of epoxy-type materials can be achieved by using a cartridge with a long nozzle that dispenses the material to the rear of the dowel hole.
3. Insert the dowel into the hole with a slight twisting motion so that the material in the back of the hole is forced up and around the dowel bar to ensure a uniform coating of the anchoring material over the dowel bar.
4. Place a thin nylon or plastic grout retention disk, (1/16" minimum thickness) manufactured to slip tightly over the dowel over the dowel and against the slab face to prevent the anchoring material from flowing out of the hole, and to create an effective face at the entrance of the dowel hole.

CONCRETE PAVEMENTS AND SHOULDERS

(08-24-09)(Rev. 07-20-10)

DB7 R20

Revise the 2006 *Standard Specifications for Roads and Structures* as follows:

**SECTION 700
GENERAL REQUIREMENT FOR PORTLAND CEMENT CONCRETE PAVING**

Page 7-1, Article 700-3 Concrete Hauling Equipment, delete the fourth paragraph and substitute the following:

For concrete hauled in a transit mix (ready mix) truck, use Table 1000-2 to determine the maximum elapsed time. For concrete hauled in other equipment, minimize the elapsed time to be 60 minutes or less, unless otherwise approved. The elapsed time is defined as the period from first contact between mixing water and cement until the entire operation of placing and finishing up to micro-surfacing, including corrective measures if necessary, has been completed.

Page 7-2, Article 700-4 Preparation of Subgrade and Base, fourth paragraph, delete the 3rd and 4th sentence and substitute the following:

Set pins at a distance no farther than 50 feet apart. When located on a vertical curve, set pins no farther than 25 feet apart.

Page 7-3, Article 700-5 (A)(4), delete the 2nd and 3rd paragraphs and substitute the following:

Where additional pavement, aggregate or soil must be placed adjacent to new pavement by machine methods, do not place it until the concrete has attained a compressive strength of at least 3000 psi.

Construction equipment or hauling equipment will not be allowed over the pavement until the concrete has attained a compressive strength of 3,000 psi.

Page 7-5, Article 700-7 Finishing, insert the following as the second sentence.

The use of excessive water for finishing will not be allowed

Page 7-5, Subarticle 700-8(C) Hot Weather, 1st sentence

Substitute 90°F for 80°F.

Page 7-7, 700-11(A) General, delete the fourth paragraph and substitute the following:

Immediately after sawing the joint to the dimensions shown on the plans, completely remove the resulting slurry from the joint. Immediately reapply curing membrane following the sawing operation to damaged areas in the vicinity of the joint.

Page 7-8, insert the following as Subarticle 700-11(G)

(G) Verification of Dowel Bar Alignment

Use either properly secured dowel baskets or a dowel bar inserter, provided the ability to correctly locate and align the dowels at the joints is demonstrated as described below.

Provide a calibrated magnetic imaging device that will document dowel bar location and alignment. Calibrate the magnetic imaging device to the type and size dowel bar used in the work. Utilize this device as a process control and make necessary adjustment to ensure the dowels are placed in the correct location.

Scan at least 25% percent of the joints in the initial placement or 1.0 mile of pavement, whichever is greater, at random intervals throughout the pavement each time the paving train is mobilized. Mark scanned joints on the pavement.

Scan all joints in this initial section if the dowel bars exhibit longitudinal translation (side shift), horizontal translation, vertical translation (depth), horizontal skew, or vertical tilt, above the allowable tolerances defined below. In addition, continue scanning 25% of the joints until it is established that the dowel bar inserter or secured dowel basket assemblies are consistently placing the dowel bars at the correct location (meeting the tolerances defined below). Once the Engineer determines that consistency is established, the Contractor may reduce the percentage of scanned joints to no less than 10%. At any time inconsistency in the placement of the dowel bars become evident, additional scanning may be required up to 100% of the joints.

If consistency of the proper dowel bar alignment cannot be established within a reasonable time frame, the Engineer will have the option of suspending the paving operation.

Provide a report of the scanned joints within 48 hours of completing the day's production. The report should include the station and lane of the joint scanned, as well as the horizontal location, depth, longitudinal translation (side shift), horizontal skew, and vertical tilt of each dowel bar in the joint. If a dowel bar inserter is used, the joint score described below should also be provided in the report.

Longitudinal translation (side shift) is defined as the position of the center of the dowel bar in relation to the sawed joint. The maximum allowable longitudinal translation (side shift) is 2 inches.

Horizontal translation is defined as difference in the actual dowel bar location from its theoretical position as detailed in the standard details. The maximum allowable horizontal translation is 2 inches.

Vertical translation (depth) is the difference in the actual dowel bar location from the theoretical midpoint of the slab. The maximum allowable vertical translation is 1/2 inch higher than the theoretical midpoint, and 1 inch lower than the theoretical midpoint. .

Dowel bar misalignment, either vertical tilt or horizontal skew, is defined as the difference in position of the dowel bar ends with respect to each other. Vertical tilt is measured in the vertical axis whereas horizontal skew is measured in the horizontal axis.

If a dowel bar inserter is used, determine a joint score for each joint scanned. The joint score is a measure of combined effects from the dowel's horizontal skew or vertical tilt. The joint score is determined by summing the product of the weight (shown in the table below) and the number of bars in each misalignment category and adding 1. The vertical tilt and horizontal skew should be evaluated and the greater misalignment shall be utilized in determining the joint score. If two lanes

are poured simultaneously, the joint score is calculated for the 24 foot section.

Misalignment Category, mm	Weight
$0 \leq d \leq 15$	0
$15 < d \leq 20$	2
$20 < d \leq 25$	4
$25 < d \leq 38$	5
$38 \leq d$	10

where d is the individual dowel bar misalignment.

A joint that has a joint score of 10 or greater will be considered locked.

When a locked joint as defined above is discovered, scan the two joints immediately adjacent to the locked joint. If either of the adjacent joints are deemed to be locked, provide a written proposal to address the dowel misalignment for each locked joint. No corrective action should be performed without written approval.

Any and all corrective action necessitated by improper joint alignment shall be at no cost to the Department.

Page 7-9, Article 700-13 USE OF NEW PAVEMENT OR SHOULDER, delete the Article in its entirety and substitute the following:

700-13 USE OF NEW PAVEMENT OR SHOULDER

Traffic or other heavy equipment will not be allowed on the concrete pavement or shoulder until the estimated compressive strength of the concrete using the maturity method has exceeded 3,000 psi unless otherwise permitted.

Estimate the compressive strength of concrete pavement in accordance with the most current version of ASTM C 1074 Standard Practice for Estimating Concrete Strength by the Maturity Method unless otherwise specified herein.

Furnish thermocouples or thermistors and digital data logging maturity meters that automatically compute and display the maturity index in terms of a temperature-time factor. The maturity meters must be capable of storing a minimum of 28 days worth of data and exporting data into an excel spreadsheet. Submit the proposed equipment to the Engineer for approval.

When establishing a strength-maturity relationship, perform compressive tests at ages 1, 3, 7, 14 and 28 days in accordance with AASHTO Test Method T22.

Use the temperature-time factor maturity function to compute the maturity index from the measured temperature history of the concrete. Set the datum temperature at -10°C to calculate the temperature-time factor in Equation 1 of ASTM C 1074.

Establish and submit a strength-maturity relationship in conjunction with each concrete pavement mix design. Determine the temperature-time factor corresponding to the strength-maturity relationship at 3,000 psi, TTF. Any changes to plant operations, material sources, or mix proportions will affect the strength-maturity relationship. If any changes occur during production, develop a new strength-maturity relationship unless otherwise directed.

Verify the strength-maturity relationship during the first day's production. Utilize the temperature-time factor developed at mix design TTF to verify the production strength-maturity relationship. Verify the strength-maturity relationship at a minimum of every 10 calendar days or when production is suspended for more than 10 days. If the verification sample's compressive strength when tested at TTF is less than 3,000 psi, immediately suspend early opening of traffic on pavement that has not obtained TTF until a new strength-maturity relationship is developed.

No permanent traffic will be allowed on the pavement until construction of the joints, including all sawing, sealing, and curing that is required, has been completed.

Take particular care to protect the exposed pavement edges and ends.

Page 7-11, Subarticle 700-15(E), Flexural Strength, delete the Subarticle and replace with the following:

(E) Compressive Strength

Determine the compressive strength of concrete using one set of two 6" x 12" cylinders at 28 calendar days. Test samples will be made by the Engineer from the concrete as it comes from the mixer. The samples will be made and cured in accordance with AASHTO T 23. Test specimens will be tested by the Engineer in accordance with AASHTO T 22. Furnish curing facilities for the test samples in accordance with Section 725

Page 7-11, Subarticle 700-15(F), Thickness, replace the first and second paragraphs with the following:

The thickness of the pavement will be determined by measurement of cores in accordance with AASHTO T 148.

Take 4-inch diameter cores in the presence of the Engineer. Take the cores when the concrete has attained a compressive strength of at least 3,000 psi and at least 72 hours have elapsed since placement of the pavement. If the concrete has not attained a compressive strength of at least 3,000 psi, the gross vehicle weight rating of vehicles supporting the coring operation may not exceed 7,000 pounds. Take cores no later than 30 days after the pavement has been placed. The core locations for each lot will be selected at random by the Engineer.

Patch all core holes within 72 hours of taking the core, using a Department approved nonshrink grout compatible with the pavement or shoulder concrete.

SECTION 710 CONCRETE PAVEMENT

Page 7-12. Article 710-1 Description, 1st sentence

Insert *and cylinders* after the words *test beams*

Insert *verifying dowel bar alignment;* after the words *sealing joints;*

Page 7-12. Article 710-3 COMPOSITION OF CONCRETE, after the first paragraph, insert the following:

Prior to placement, concrete produced by the plant must demonstrate that it is represented by the mix design submitted. The Engineer will make compressive and flexural samples from plant produced mix for testing at 1, 3, 7, 14 and 28 days of age. The strength results must be within 10% of the strengths reported by the Contractor during the mix design process. If the plant produced mix meets this criteria at 14 days of age, the Engineer will notify the Contractor that placement of concrete may commence.

If any major change as defined in section 1000-3 is made to the mix design, the process shall be initiated again.

Page 7-12. Article 710-4 ACCEPTANCE OF CONCRETE, delete the first sentence and replace with the following:

Test the concrete pavement for acceptance with respect to compressive strength and thickness on a lot by lot basis in accordance with the requirements of Article 700 15 and the following requirements:

For all concrete pavement, including mainline, shoulders, ramps, tapers, intersections, entrances, crossovers, and irregular areas not otherwise defined, produce a lot consisting of 1,333.3 square yards or fraction thereof placed within 28 calendar days. From each lot, make a minimum of one set of two 6" x 12" cylinders from a randomly selected batch of concrete. The average compression strength of the two cylinders is considered one test. If Division of Highways personnel make and test additional sets of cylinders for a lot, these sets will be averaged with the original set to determine the strength. In the case of low strength, the Engineer will perform an investigation.

Page 7-13, Article 710-6 Finishing, insert the following at the end of the 6th paragraph.

Provide a textured surface with an average texture depth of 0.8 mm as tested in accordance with ASTM E 965 (*Test Method for Measuring Pavement Macrot texture Depth Using a Sand Volumetric Technique*) with no single test having a texture depth of 0.5 mm or less. Perform four randomly located tests in accordance with ASTM E 965 within the initial pavement lot of each mobilization and provide test results to the Engineer. A lot is defined in Article 710-4. If the average of the four tests does not meet the above criteria, make appropriate changes to the surface texture operations and test the next lot as detailed above. Once the surface texture process is established to meet minimum texture requirements, maintain consistency within the operation to provide the above minimum texture depth. Perform additional sand patch tests in accordance with ASTM E 965 when directed.

Should the surface texture become damaged or reduced by rain, or any other action, reestablish or restore surface texture by an approved method.

Page 7-15, Article 710-9 Thickness Tolerances, delete the 4th and 5th paragraph and substitute with the following:

When the measurement of the core from a lot is deficient by 0.2" or less from the plan thickness, full payment will be made. When such measurement is deficient by more than 0.2" from the plan thickness, take 2 additional cores at random within the lot and calculate the average thickness of the lot from the 3 cores.

In determining the average thickness of the pavement lot, the Engineer will use all 3 core measurements. Individual core measurements which are greater than the plan thickness plus 0.2" will be considered as the plan thickness plus 0.2". Individual cores which are less than the plan thickness minus 1.0" will be considered as the plan thickness minus 1.0 inch. If the average measurement of the 3 cores is within 0.2" from the plan thickness, full payment will be made. If the average measurement of the 3 cores is deficient by more than 0.2" from the plan thickness, an adjusted unit price in accordance with Subarticle 710-10(B) will be paid for the lot represented.

Areas found deficient in thickness by more than 1.0" will be removed and replaced with concrete of the thickness shown on the plans. Any full lane or full shoulder width repairs to the concrete pavement must be performed in accordance with the North Carolina Department of Transportation Partial and Full Depth Repair Manual and not be less than 1/2 of the panel length (7.5 feet)

When the measurement of any core (original core or additional cores taken to calculate the average) is less than the plan thickness by more than 1.0", the extent of the removal area due to thickness deficiency will be determined by taking additional exploratory cores at approximately 10 foot intervals parallel to the center line in each direction from the deficient core until an exploratory core is found in each direction which is within 1.0" of the plan thickness. The pavement between these exploratory cores will be removed full

lane width wide and replaced with concrete of the thickness shown on the plans. Exploratory cores for deficient thickness will not be used in averages for adjusted unit price.

Patch all core holes within 72 hours of taking the core, using a Department approved nonshrink grout compatible with the pavement concrete.

Page 7-16, Subarticle 710-10 (A) GENERAL, delete the second paragraph and substitute the following:

Separate measurement will be made of pavement that is deficient in thickness by more than 0.2" and of pavement that is deficient in compressive strength.

Page 7-17, Subarticle 710-10 (C) Concrete Pavement Varying in Flexural Strength, delete the title, first paragraph and the equation for the pay factor calculation and substitute the following:

(C) Concrete Pavement Varying In Compressive Strength

The pay factor for pavement achieving a compressive strength in 28 days of 4,500 psi or greater is 100%. The pay factor for pavement achieving a compressive strength in 28 days between 3000 psi and 4,500 psi is determined by the following formula:

$$\text{Pay Factor (\%)} = 0.0333(\text{PSI}) - 50$$

(pay factor rounded to nearest tenth of one percent)

Page 7-17, Subarticle 710-10 (C) Concrete Pavement Varying in Flexural Strength, delete the first sentence of the third paragraph and substitute the following:

Any pavement that fails to attain 3,000 psi in compression is subject to removal.

Page 7-19, Article 720-4 ACCEPTANCE OF CONCRETE, delete the first sentence and substitute the following:

Concrete shoulders will be tested for acceptance with respect to compressive strength and thickness on a lot by lot basis.

Page 7-19, Subarticle 720-9, Thickness Tolerances, replace the first paragraph with the following:

The thickness of the shoulder will be determined by measurement of cores in accordance with AASHTO T 148.

Page 7-20, Subarticle 720-10 (C) Concrete Shoulder Varying in Flexural Strength, delete the title and the first sentence of the second paragraph and substitute the following, respectively:

(C) Concrete Shoulder Varying in Compressive Strength

The quantities of concrete shoulder that fail to meet 4,500 psi, measured as provided in Article 710-10, will be paid for at an adjusted unit price per square yard, completed in place and accepted.

SECTION 725

FIELD LABORATORY FOR PORTLAND CEMENT CONCRETE PAVEMENT

Page 7-21, Subarticle 725-2, General Requirements, replace with the following:

Furnish and maintain for the exclusive use of the Engineer a field office and laboratory in which to house and use all testing equipment needed. Only Department representatives will have access to these facilities. Provide a field office that is dust and water tight, floored, and has an adequate foundation so as to prevent excessive floor movement. Provide a field office that contains 6 or more 110 volt electrical double outlets properly grounded and spaced; a telephone; at least 2 windows, satisfactory locks on all doors and windows; adequate lighting, heating, and air conditioning; sink; running water to sink; and satisfactory exhaust fan. Provide a field office that meets the following approximate minimum requirements: 200 square feet of floor space; 10 feet interior width; 6 feet 6 inches interior height; 20 square feet of counter space, 2.5 to 3 feet high and 2 feet deep with cabinets or drawers below the counter top; and 6 square feet of desk space not enclosed with cabinets. Locate the office in a position that will permit full view of the plant from the interior of the office. At or near the office, furnish toilet facilities, with waste disposal, available for use of the Department personnel. Maintain these toilets in a neat and clean condition.

Provide a laboratory trailer adjacent to the field office that is at least 400 square feet in area, approximately 20 feet wide, 20 feet long, and 7 feet in height. Provide a laboratory trailer that contains 6 or more 110 volt electrical double outlets properly grounded and spaced; satisfactory locks on all doors and windows; adequate lighting, heating, and air conditioning; sink; running water to sink; and satisfactory exhaust fans. Provide two workbenches that are approximately 10 feet long, 2 feet wide, and 2.5 feet high. One workbench shall be installed inside the trailer and the other across the end of the trailer. Provide a shelter or roof over the outside workbench to provide protection from weather. Provide, in the laboratory, an adequate number of water storage tanks to hold all acceptance beams and cylinders and any additional beams and cylinders made for the purpose of determining early strengths. Construct the water storage tanks of non-corroding materials and have requirements for automatic control of the water temperature. Maintain the water in the tank at a temperature of $73^{\circ} \text{ F} \pm 3^{\circ} \text{ F}$. Equip each tank with a recording thermometer with its bulb located in the water. Provide sufficient tank volume to maintain all beams and cylinders, stored with the long axis vertical, in a fully submerged condition for the duration of the required curing period. Furnish a wooden mixing board at least 3/4 inch thick and approximately 4 feet wide and 4 feet long, that is covered on one side with

sheet metal of at least 22 gage, at the shelter. Provide facilities to maintain the test beams and cylinders at temperature between 60° F and 80° F during initial curing.

SECTION 1000

PORTLAND CEMENT CONCRETE PRODUCTION AND DELIVERY

Page 10-2, Subarticle 1000-3(A) Composition and Design, delete the Subarticle and substitute the following:

Submit concrete paving mix design in terms of saturated surface dry weights on M&T Form 312U for approval a minimum of 30 days prior to proposed use. Use a mix that contains a minimum of 526 pounds of cement per cubic yard, a maximum water cement ratio of 0.559, an air content in the range of 4.5 to 5.5 percent, a maximum slump of 1.5" and a minimum flexural strength of 650 psi and a minimum compressive strength of 4,500 psi at 28 days.

The cement content of the mix design may be reduced by a maximum of 20% and replaced with fly ash at a minimum rate of 1.2 pounds of fly ash to each pound of cement replaced. Use a maximum water-cementitious material ratio not to exceed 0.538.

The cement content of the mix design may be reduced by a maximum of 50% and replaced with blast furnace slag pound for pound.

Include in the mix design the source of aggregates, cement, fly ash, slag, and admixtures; the gradation and specific gravity of the aggregates; the fineness modulus (F.M.) of the fine aggregate; and the dry rodded unit weight and size of the coarse aggregate. Submit test results showing that the mix design conforms to the criteria, including the 1, 3, 7, 14 and 28-day strengths of the average of two beams and the average of two cylinders for each age made and tested in accordance with AASHTO R39, T22 and T97. Design the mix to produce an average strength sufficient to indicate that a minimum strength of 650 psi in flexure and 4,500 psi in compression will be achieved in the field within 28 days.

If any change is made to the mix design, submit a new mix design.

If any major change is made to the mix design, also submit new test results showing the mix design conforms to the criteria. A major change to the mix design is defined as:

- 1) A source change in Coarse aggregate, Fine aggregate, Cement or Pozzolan (applies only to a change from one type of pozzolan to another; e.g., Class F fly ash to Class C fly ash)

- 2) A quantitative change in Coarse aggregate (applies to an increase or decrease greater than 5 %), Fine aggregate (applies to an increase or decrease greater than 5 %), Water (applies to an increase only), Cement (applies to a decrease only), Pozzolan (applies to a decrease only).

Where concrete with a higher slump for hand methods of placing and finishing is necessary, submit an adjusted mix design for approval to provide a maximum slump of 3" and to maintain the water-cementitious material ratio established by the original mix design.

Page 10-6, Table 1000-1, under column titled “Minimum compressive Strength at 28 days, psi”, in row titled “Pavement”, delete “560 flexural” and substitute “4,500”

SUBSURFACE DRAINAGE

(07-20-10)

DB8 R05

Revise the *2006 Standard Specifications for Roads and Structures* as follows:

Page 8-13, Delete Section 815 SUBSURFACE DRAINAGE and replace it with the following:

Description

Construct subsurface drains, underdrains, blind drains and other types of drains in accordance with the contract or as directed by the Engineer. Install markers to locate concrete pads for drains as shown on the plans. This provision does not apply to shoulder drains.

Materials

Refer to Division 10 of the *Standard Specifications*.

Item	Section
Portland Cement Concrete, Class B	1000
Select Material, Class V	1016
Subsurface Drainage Materials	1044
Filter Fabric for Subsurface Drains, Type 1	1056
Steel Markers	1072-4
Steel Marker Paint	1080-14
Pavement Marker Paint	1087

Use Class B Concrete for concrete pads and Class V Select Material for subdrain coarse aggregate. Provide subdrain coarse aggregate for subsurface drains and subdrain fine aggregate for underdrains and blind drains.

Construction Methods

Do not leave filter fabrics uncovered for more than 7 days. Excavate trenches as necessary in accordance with the contract or as directed by the Engineer. For subsurface drains, line trench with filter fabric and overlap fabric ends a minimum of 6" on top of subdrain coarse aggregate.

Install blind drains at a depth of 4 to 6 ft below subgrade elevation. Install subdrain pipes for subsurface drains and underdrains at a depth of 4 to 6 ft below subgrade elevation unless the subgrade will be proof rolled. For subsurface drains and underdrains in subgrades that will be proof rolled, install subdrain pipes at a depth of 6 ft below subgrade elevation. Firmly connect

subdrain pipes together as needed. Place perforated subdrain pipes with perforations down except for pipes in dry materials, in which case turn perforations up or use non-perforated pipes. For concrete pipes in dry materials, construct mortar joints in accordance with Subarticle 300-6(A) of the *Standard Specifications*.

Place subdrain aggregate beneath, around and over subdrain pipes such that pipes are covered by at least 6" of aggregate unless shown otherwise on the plans. Do not displace or damage subdrain pipes while placing and compacting subdrain aggregate. Lightly compact backfill material such that settlement is minimized.

Use solvent cement for connecting polyvinyl chloride (PVC) outlet pipes and fittings such as wyes, tees and elbows. Provide connectors for outlet pipes and fittings that are watertight and suitable for gravity flow conditions. Cover open ends of outlet pipes with rodent screens as shown on the plans.

Connect drains to concrete pads or existing drainage structures at ends of outlet pipes. Construct concrete pads and provide an Ordinary Surface Finish in accordance with Subarticle 825-6(B) of the *Standard Specifications*. Furnish and install steel and pavement markers at concrete pads as shown on the plans.

Allow drains to function for up to 30 days or a sufficient time as determined by the Engineer before undercutting, proof rolling or constructing embankments over drains.

GUARDRAIL ANCHOR UNITS, TYPE M-350

(04-20-04)

DB8 R60

Description

Furnish and install guardrail anchor units in accordance with the details in the plans developed by the Design-Build Team, the applicable requirements of Section 862 of the 2006 *Standard Specifications for Roads and Structures*, and at locations shown in the plans.

Materials

The Design Build Team may, at his option, furnish any one of the following guardrail anchor units.

The guardrail anchor unit (SRT-350) as manufactured by:

TRINITY INDUSTRIES, INC.
2525 N. STEMMONS FREEWAY
DALLAS, TEXAS 75207
TELEPHONE: 800 644-7976

The guardrail anchor unit (FLEAT) as manufactured by:

ROAD SYSTEMS, INC.
3616 OLD HOWARD COUNTY AIRPORT
BIG SPRINGS, TEXAS 79720
TELEPHONE: 915-263-2435

The guardrail anchor unit (REGENT) as manufactured by:

ENERGY ABSORPTION SYSTEMS, INC.
ONE EAST WACKER DRIVE
CHICAGO, ILLINOIS 60601-2076
TELEPHONE: 888-32-ENERGY

Prior to installation the Design Build Team shall submit to the Engineer:

1. FHWA acceptance letter for each guardrail anchor unit certifying it meets the requirements of NCHRP Report 350, Test Level 3, in accordance with Section 106-2 of the 2006 *Standard Specifications for Roads and Structures*.
2. Certified working drawings and assembling instructions from the manufacturer for each guardrail anchor unit in accordance with Section 105-2 of the 2006 *Standard Specifications for Roads and Structures*.

No modifications shall be made to the guardrail anchor unit without the express written permission from the manufacturer. Perform installation in accordance with the details in the plans, and details and assembling instructions furnished by the manufacturer.

Construction

Guardrail end delineation is required on all approach and trailing end sections for both temporary and permanent installations. Guardrail end delineation consists of yellow reflective sheeting applied to the entire end section of the guardrail in accordance with Section 1088-3 of the 2006 *Standard Specifications for Roads and Structures* and is incidental to the cost of the guardrail anchor unit.

GUARDRAIL ANCHOR UNITS, TYPE 350

(04-20-04)

DB8 R65

Description

Furnish and install guardrail anchor units in accordance with the details in the plans as developed by the Design-Build Team, the applicable requirements of Section 862 of the 2006 *Standard Specifications for Roads and Structures*, and at locations shown in the plans.

Materials

The Design-Build Team may at his option, furnish any one of the guardrail anchor units.

Guardrail anchor unit (ET-2000) as manufactured by:

TRINITY INDUSTRIES, INC.
2525 N. STEMMONS FREEWAY
DALLAS, TEXAS 75207
TELEPHONE: 800-644-7976

The guardrail anchor unit (SKT 350) as manufactured by:

ROAD SYSTEMS, INC.
3616 OLD HOWARD COUNTY AIRPORT
BIG SPRING, TEXAS 79720
TELEPHONE: 915 263-2435

Prior to installation the Design-Build Team shall submit to the Engineer:

1. FHWA acceptance letter for each guardrail anchor unit certifying it meets the requirements of NCHRP Report 350, Test Level 3, in accordance with Section 106-2 of 2006 *Standard Specifications for Roads and Structures*.
2. Certified working drawings and assembling instructions from the manufacturer for each guardrail anchor unit in accordance with Section 105-2 of the 2006 *Standard Specifications for Roads and Structures*.

No modifications shall be made to the guardrail anchor unit without the express written permission from the manufacturer. Perform installation in accordance with the details in the plans, and details and assembling instructions furnished by the manufacturer.

Construction

Guardrail end delineation is required on all approach and trailing end sections for both temporary and permanent installations. Guardrail end delineation consists of yellow reflective sheeting applied to the entire end section of the guardrail in accordance with Section 1088-3 of the 2006 *Standard Specifications for Roads and Structures* and is incidental to the cost of the guardrail anchor unit.

IMPACT ATTENUATOR UNITS, TYPE 350

(04-20-04) (Rev. 7-18-06)

DB8 R75

Description

Furnish and install impact attenuator units and any components necessary to connect the impact attenuator units in accordance with the manufacturer's requirement, the details in the plans and at locations shown in the plans.

Materials**NON-GATING IMPACT ATTENUATOR UNITS:**

The impact attenuator unit (QUADGUARD) as manufactured by:

ENERGY ABSORPTION SYSTEMS, INC.
ONE EAST WACKER DRIVE
CHICAGO, ILLINOIS 60601-2076
TELEPHONE: 312-467-6750

The impact attenuator unit (TRACC) as manufactured by:

TRINITY INDUSTRIES, INC.
2525 N. STEMMONS FREEWAY
DALLAS, TEXAS 75207
TELEPHONE: 1-800-644-7976

GATING IMPACT ATTENUATOR UNITS:

The impact attenuator unit (BRAKEMASTER) as manufactured by:

ENERGY ABSORPTION SYSTEMS, INC.
ONE EAST WACKER DRIVE
CHICAGO, ILLINOIS 60601-2076
TELEPHONE: 312-467-6750

The impact attenuator unit (CAT) as manufactured by:

TRINITY INDUSTRIES, INC.
2525 N. STEMMONS FREEWAY
DALLAS, TEXAS 75207
TELEPHONE: 1-800-644-7976

Prior to installation the Design-Build Team shall submit to the Engineer:

1. FHWA acceptance letter for each impact attenuator unit certifying it meets the requirements of NCHRP Report 350, Test Level 3, in accordance with Section 106-2 of the 2006 *Standard Specifications for Roads and Structures*.
2. Certified working drawings and assembling instructions from the manufacturer for each impact attenuator unit in accordance with Section 105-2 of the 2006 *Standard Specifications for Roads and Structures*.

No modifications shall be made to the impact attenuator unit without the express written permission from the manufacturer. Perform installation in accordance with the details in the plans, and details and assembling instructions furnished by the manufacturer.

Construction Methods

If the median width is 40 feet or less, the Design-Build Team shall supply one of the NON-GATING Impact Attenuator Units listed in the Materials Section herein.

If the median width is greater than 40 feet, the Design-Build Team may use any of the GATING or NON-GATING Impact Attenuator Units listed in the Materials Section herein.

FENCE

(03-06-06)

DB8 R86

Revise the 2006 *Standard Specifications for Roads and Structures* as follows:

Page 8-54, Subarticle 866-3(A), second sentence,

Add *existing fencing* after stumps

PREFORMED SCOUR HOLE WITH LEVEL SPREADER APRON

(08-24-09)

DB8 R105

Description

Construct and maintain preformed scour holes with spreader aprons at the locations shown on the plans and in accordance with the details in the plans. Work includes excavation, shaping and maintaining the hole and apron, furnishing and placing filter fabric, rip rap (class as specified in the plans) and permanent soil reinforcement matting.

Materials

Item	Section
Plain rip rap	1042
Filter Fabric	1056

The permanent soil reinforcement matting shall be permanent erosion control reinforcement mat and shall be constructed of synthetic or a combination of coconut and synthetic fibers evenly distributed throughout the mat between a bottom UV stabilized netting and a heavy duty UV stabilized top net. The matting shall be stitched together with UV stabilized polypropylene thread to form a permanent three dimensional structure. The mat shall have the following minimum physical properties:

<i>Property</i>	<i>Test Method</i>	<i>Value Unit</i>
Light Penetration	ASTM D6567	9 %
Thickness	ASTM D6525	0.40 in
Mass Per Unit Area	ASTM D6566	0.55 lb/sy
Tensile Strength	ASTM D6818	385 lb/ft
Elongation (Maximum)	ASTM D6818	49 %
Resiliency	ASTM D1777	>70 %
UV Stability *	ASTM 4355	≥80 %
Porosity (Permanent Net)	ECTC Guidelines	≥85 %
Maximum Permissible Shear Stress (Vegetated)	Performance Bench Test	≥8.0 lb/ft ²
Maximum Allowable Velocity (Vegetated)	Performance Bench Test	≥16.0 ft/s

*ASTM D1682 Tensile Strength and % strength retention of material after 1000 hours of exposure.

A certification (Type 1, 2, or 3) from the manufacturer showing:

- (A) the chemical and physical properties of the mat used, and
- (B) conformance of the mat with this specification will be required.

Construction Methods

All areas to be protected with the mat shall be brought to final grade and seeded in accordance with Section 1660 of the *Standard Specifications*. The surface of the soil shall be smooth, firm, stable and free of rocks, clods, roots or other obstructions that would prevent the mat from lying in direct contact with the soil surface. Areas where the mat is to be placed will not need to be mulched.

STREET SIGNS AND MARKERS AND ROUTE MARKERS

(07-01-95)

DB9 R01

Move any existing street signs, markers, and route markers out of the construction limits of the project and install the street signs and markers and route markers so that they will be visible to the traveling public if there is sufficient right of way for these signs and markers outside of the construction limits.

Near the completion of the project and when so directed by the Engineer, move the signs and markers and install them in their proper location in regard to the finished pavement of the project.

Stockpile any signs or markers that cannot be relocated due to lack of right of way, or any signs and markers that will no longer be applicable after the construction of the project, at locations directed by the Engineer for removal by others.

The Design-Build Team shall be responsible to the owners for any damage to any street signs and markers or route markers during the above described operations.

STEEL U-CHANNEL POSTS

(07-18-06)

DB9 R02

Amend the 2006 *Standard Specifications for Roads and Structures* as follows:

Page 9-15 Subarticle 903-3(D) first paragraph, last sentence, delete the last sentence and add the following:

Use posts of sufficient length to permit the appropriate sign mounting height. Spliced posts are not permitted on new construction.

SHIPPING SIGNS

(05-15-07)

DB9 R03

Revise the 2006 *Standard Specifications for Roads and Structures* as follows:

Page 9-2, Section 901-3(A), General, add the following as the 7th paragraph:

Ship all multi-panel signs to the project intact, completely assembled and ready to be hung. Fabricate signs taller than 12 ft as 2 separate signs with a horizontal splice, ready to be spliced and hung. No assembly other than a horizontal splice will be permitted.

GALVANIZED HIGH STRENGTH BOLTS, NUTS AND WASHERS

(02-17-09)

DB10 R02

Revise the 2006 *Standard Specifications for Roads and Structures* as follows:

Page 10-126, Subarticle 1072-7(F)(3) Change the AASHTO reference to B 695 Class 55

Page 10-247, Table 1092-2, Steel Sign Materials, Change High Strength Bolts, Nuts & Washers ASTM Specifications for Galvanizing to B695 Class 55.

Page 10-259, Subarticle 1094-1(A) Breakaway or Simple Steel Beam Sign Supports, replace the third paragraph with the following:

Fabricate high strength bolts, nuts, and washers required for breakaway supports from steel in accordance with ASTM A325 and galvanize in accordance with AASHTO B 695 Class 55.

Page 10-261, Article 1096-2 Steel Overhead Sign Structures, replace the last sentence with the following:

The galvanizing shall meet the requirement of AASHTO B 695 Class 55 for fasteners and of ASTM A123 for other structural steel.

GALVANIZING

(8-17-10)

DB10 R03

Revise the *Standard Specifications* as follows:

Page 10-150, Subarticle 1076-1, Galvanizing, add a second paragraph as the follows:

Allow the Engineer to obtain samples of molten zinc directly from the galvanizing vat upon request.

AGGREGATE PRODUCTION

(11-20-01)

DB10 R05

Provide aggregate from a producer who utilizes the new Aggregate Quality Control / Quality Assurance Program that is in effect at the time of shipment.

No price adjustment is allowed to Design-Build Team or producers who utilize the new program. Participation in the new program does not relieve the producer of the responsibility of complying with all requirements of the 2006 *Standard Specifications for Roads and Structures*. Copies of this procedure are available upon request from the Materials and Test Unit.

CONCRETE BRICK AND BLOCK PRODUCTION

(11-20-01)

DB10 R10

Provide concrete brick and block from a producer who utilizes the new Solid Concrete Masonry Brick / Unit Quality Control / Quality Assurance Program that is in effect on the date that material is received on the project.

No price adjustment is allowed to Design-Build Team or producers who utilize the new program. Participation in the new program does not relieve the producer of the responsibility of complying with all requirements of the 2006 *Standard Specifications for Roads and Structures*. Copies of this procedure are available upon request from the Materials and Test Unit.

PORTLAND CEMENT CONCRETE (Alkali-Silica Reaction)

(02-20-07)

DB10 R16

Revise the 2006 *Standard Specifications for Roads and Structures* as follows:

Article 1024-1(A), replace the 2nd paragraph with the following:

Certain combinations of cement and aggregate exhibit an adverse alkali-silica reaction. The alkalinity of any cement, expressed as sodium-oxide equivalent, shall not exceed 1.0 percent. For mix designs that contain non-reactive aggregates and cement with an alkali content less than 0.6%, straight cement or a combination of cement and fly ash, cement and ground granulated blast furnace slag or cement and microsilica may be used. The pozzolan quantity shall not exceed the amount shown in Table 1024-1. For mixes that contain cement with an alkali content between 0.6% and 1.0%, and for mixes that contain a reactive aggregate documented by the Department, regardless of the alkali content of the cement, use a pozzolan in the amount shown in Table 1024-1.

Obtain the list of reactive aggregates documented by the Department at:

<http://www.ncdot.org/doh/operations/materials/pdf/quarryasrprob.pdf>

Table 1024-1	
Pozzolans for Use in Portland Cement Concrete	
<i>Pozzolan</i>	<i>Rate</i>
Class F Fly Ash	20% by weight of required cement content, with 1.2 lbs Class F fly ash per lb of cement replaced
Ground Granulated Blast Furnace Slag	35%-50% by weight of required cement content with 1 lb slag per lb of cement replaced
Microsilica	4%-8% by weight of required cement content, with 1 lb microsilica per lb of cement replaced

GLASS BEADS

(7-18-06)(Rev 10-19-10)

DB10 R35

Revise the 2006 *Standard Specifications for Roads and Structures* as follows:

Page 10-223, 1087-4(A) Composition, add the following as the fourth paragraph:

Glass beads shall have no more than 75 parts per million of arsenic as determined by the United States Environmental Protection Agency Method 6010B in conjunction with the United States Environmental Protection Agency Method 3052 modified.

Page 10-223, 1087-4(C) Gradation & Roundness, delete the last paragraph and replace the second sentence of the first paragraph with the following:

All Drop-On and Intermixed Glass Beads shall be tested in accordance with ASTM D1155.

Page 10-226, 1087-8 Material Certification, add the following below the first sentence:

Glass Beads (for paint, thermoplastic and polyurea) – Type 3 Material Certification for no more than 75 parts per million of arsenic.

ENGINEERING FABRICS

(7-18-06) (Rev 10-19-10)

DB10 R40

Revise the 2006 *Standard Specifications for Roads and Structures* as follows:

Page 10-99, Delete Section 1056 ENGINEERING FABRICS and replace it with the following:

SECTION 1056 ENGINEERING FABRICS

1056-1 General

Use engineering fabrics that meet the requirements of Article 4.1 of AASHTO M288 and have been evaluated by National Transportation Product Evaluation Program (NTPEP). When required, sew fabrics together in accordance with Article X1.1.4 of AASHTO M288. Provide sewn seams with seam strengths meeting the required strengths for the engineering fabric type and class specified.

Load, transport, unload and store fabrics such that they are kept clean and free of damage. Label, ship and store fabrics in accordance with Section 7 of AASHTO M288. Fabrics with defects, flaws, deterioration or damage will be rejected. Do not unwrap fabrics until just before installation. With the exception of fabrics for temporary silt fences and mechanically stabilized earth (MSE) wall faces, do not leave fabrics exposed for more than 7 days before covering fabrics with material.

When required, use pins a minimum of 3/16" in diameter and 18" long with a point at one end and a head at the other end that will retain a steel washer with a minimum outside diameter of 1.5". When wire staples are required, provide staples in accordance with Subarticle 1060-8(D) of the 2006 *Standard Specifications for Roads and Structures*.

1056-2 Fabric Properties

Provide Type 1 Certified Mill Test Report, Type 2 Typical Certified Mill Test Report or Type 4 Certified Test Report in accordance with Article 106-3 of the 2006 *Standard Specifications for Roads and Structures*. Furnish certifications with minimum average roll values (MARV) as defined by ASTM D4439 for all fabric properties with the exception of elongation. For testing fabrics, a lot is defined as a single day's production.

Provide engineering fabric types and as submitted and accepted by the Department. Machine direction (MD) and cross-machine direction (CD) are as defined by ASTM D4439. Use woven or nonwoven fabrics with properties meeting the requirements of Table 1056-1.

**TABLE 1056-1
FABRIC PROPERTY REQUIREMENTS**

Property	ASTM Test Method	Requirements (MARV ¹)				
		Type 1	Type 2	Type 3 ²	Type 4	Type 5 ³
<i>Typical Application</i>		<i>Shoulder Drains</i>	<i>Under Riprap</i>	<i>Temporary Silt Fence</i>	<i>Soil Stabilization</i>	<i>Temporary MSE Walls</i>
Elongation (MD & CD)	D4632	≥ 50 %	≥ 50 %	≤ 25 %	< 50 %	< 50 %
Grab Strength (MD & CD)	D4632	90 lbs	205 lbs	100 lbs	180 lbs	---
Tear Strength (MD & CD)	D4533	40 lbs	80 lbs	---	70 lbs	---
Puncture Strength	D6241	220 lbs	440 lbs	---	370 lbs	---
Wide Width Tensile Strength @ Ultimate (MD & CD)	D4595	---	---	---	---	2400 lbs/ft (unless required otherwise in the contract)
Permittivity	D4491	0.20 sec ⁻¹	0.20 sec ⁻¹	0.05 sec ⁻¹	0.05 sec ⁻¹	0.20 sec ⁻¹
Apparent Opening Size ⁴	D4751	#60	#60	#30	#40	#30
Ultraviolet Stability (retained strength) ⁵	D4355	50 %	50 %	70 %	50 %	50%

¹MARV does not apply to elongation
²Minimum roll width of 36" required
³Minimum roll width of 13 ft required
⁴US Sieve No. per AASHTO M92
⁵After 500 hours of exposure

QUALIFICATION OF WELDS AND PROCEDURES

(06-03-09)

DB 10 R43

Page 10-143, Subarticle 1072-20(D) Qualification of Welds and Procedures, replace the third sentence of the first paragraph with the following:

For all prequalified field welds, submit Welding Procedure Specifications (WPS) for each joint configuration for approval at least 30 days prior to performing any welding. In lieu of this, use the WPS provided and preapproved by the Department. These preapproved WPS are available from the Materials and Tests Unit or at:

http://www.ncdot.org/doh/operations/materials/structural/appr_proc.html.

Use non-prequalified welds only if approved by the Engineer. Submit WPS for all non-prequalified welds to the Engineer for approval. At no cost to the Department, demonstrate their adequacy in accordance with the requirements of the Bridge Welding Code.

PAINT SAMPLING AND TESTING

(08-15-06)

DB10 R 45

Revise the 2006 *Standard Specifications for Roads and Structures* as follows:

Page 10-190, Article 1080-4, Delete the first paragraph and replace with the following:

All paint will be sampled, either at the point of manufacture or at the point of destination. Inspection and sampling will be performed at the point of manufacture wherever possible. The Design-Build Team shall not begin painting until the analysis of the paint has been performed, and the paint has been accepted.

PORTABLE CONCRETE BARRIER

(02-20-07)

DB10 R50

The 2006 *Standard Specifications for Roads and Structures* shall be revised as follows:

Page 10-245, Article 1090-1(A) General, add the following after the first sentence:

The requirement for approved galvanized connectors will be waived if the barrier remains the property of the Design-Build Team.

CHANNELIZING DEVICES (Drums):

(07-20-10)

DB10 R60

Revise the 2006 *Standard Specifications for Roads and Structures* as follows:

Page 10-236, Subarticle 1089-5(A) Drums (1) General, replace the paragraph with the following:

(1) General

Provide drums composed of a body, alternating orange and white 4 band pattern of Type III-High Intensity Microprismatic Sheeting and ballasts that have been evaluated by NTPEP.

The following guidelines will be used during the transition from drums with the standard 5 band engineer's grade sheeting to the new 4 band configuration.

- (a) All **new** drums purchased **after July 20, 2010** shall have the new sheeting and 4 band configuration.

(b) Existing 5 band drums with engineer's grade sheeting (both new and used devices in existing inventories) will be allowed for use on all on-going construction projects until project completion and will also be allowed for use on other projects until a sunset date has been established.

(c) Intermixing of "old drums" and "new drums" on the same project is acceptable during the transition.

(d) 4 band drums with engineer's grade sheeting will not be allowed at anytime.

Page 10-236, Subarticle 1089-5(A) Drums (3) Retroreflective Stripes, replace the paragraph with the following:

(3) Retroreflective Bands

Provide a minimum of 4 retroreflective bands- 2 orange and 2 white alternating horizontal circumferential bands. The top band shall always be orange. Use a 6" to 8" wide band Type III-High Intensity Microprismatic Retroreflective Sheeting or better that meets the requirement of Section 1093 for each band. Do not exceed 2" for any non-reflective spaces between orange and white stripes. Do not splice the retroreflective sheeting to create the 6-inch band. Apply the retroreflective sheeting directly to the drum surface. Do not apply the retroreflective sheeting over a pre-existing layer of retroreflective sheeting. Do not place bands over any protruding corrugations areas. No damage to the reflective sheeting should result from stacking and unstacking the drums, or vehicle impact.

Page 10-237, Subarticle 1089-5 (B) Skinny-Drums (1) General, replace the paragraph with the following:

(1) General

All existing skinny-drums that do not have Type III-High Intensity Microprismatic Sheeting as a minimum will have the same transition requirements as drums as stated above. All **new** skinny-drums purchased **after July 20, 2010** shall have Type III-High Intensity Microprismatic Sheeting as the minimum. Type IV and higher grade sheeting is acceptable for use on both new and used devices.

Provide skinny-drums composed of a body, reflective bands, and ballasts that have been evaluated by NTPEP.

Page 10-237, Subarticle 1089-5 (B) Skinny Drums (3) Retroreflective Stripes, replace the paragraph with the following:

(3) Retroreflective Bands

Provide a minimum of 4 retroreflective bands- 2 orange and 2 white alternating horizontal circumferential bands for each skinny-drum. The top band shall always be orange. Use a 6" to 8" wide band Type III-High Intensity Microprismatic Retroreflective Sheeting or better that meets the requirement of Section 1093 for each band. Do not exceed 2" for any non-reflective spaces between orange and white stripes. Do not splice the retroreflective sheeting to create the 6-inch band. Apply the retroreflective sheeting directly to the skinny-drum surface. Do not apply the retroreflective sheeting over a pre-existing layer of retroreflective sheeting. Do not place bands over any protruding corrugations areas. No damage to the reflective sheeting should result from stacking and unstacking the skinny-drums, or vehicle impact.

TEMPORARY SHORING

(09-25-07)

DB11 R02

Description

Design and construct temporary shoring in accordance with the contract. Temporary shoring includes standard shoring, temporary mechanically stabilized earth (MSE) walls and non-anchored temporary shoring. Trench boxes are not considered temporary shoring. "Standard shoring" refers to *standard temporary shoring* and *standard temporary MSE walls*. Notes on plans may restrict the use of one or both types of standard shoring. Notes on plans may also require or prohibit temporary MSE walls.

Unless noted otherwise on the plans, temporary shoring is required as shown on the plans and to maintain traffic. Temporary shoring to maintain traffic is defined as shoring necessary to provide lateral support to the side of an excavation or embankment parallel to an open travelway when a theoretical 2:1 (H:V) slope from the bottom of the excavation or embankment intersects the existing ground line closer than 5 ft from the edge of pavement of the open travelway.

This provision is not applicable to anchored temporary shoring or the installation of pipes, drop inlets and utilities unless noted otherwise on the plans. Provide all shoring submittals before beginning work.

Materials

(A) **Certifications, Storage and Handling**

Provide Type 7 Contractor's Certifications in accordance with Article 106-3 of the 2006 *Standard Specifications for Roads and Structures* for all shoring materials used with the exception of reinforcing fabrics and geogrids. Furnish Type 2 Typical Certified Mill Test Reports in accordance with Article 106-3 of the 2006 *Standard Specifications for Roads and Structures* for all seam strengths and reinforcing fabric and geogrid properties. Provide minimum average roll values (MARV) in accordance with ASTM D4759 for test reports. For testing reinforcing fabric and geogrids, a lot is defined as a single day's production.

Load, transport, unload and store shoring materials such that they are kept clean and free of damage. Identify, store and handle all geogrids and geotextile fabrics in accordance with ASTM D4873. Geogrids and fabrics with defects, flaws, deterioration or damage will be rejected. Do not leave fabrics or geogrids uncovered for more than 7 days.

(B) Shoring Backfill

Use shoring backfill for the construction of all temporary shoring including backfilling behind non-anchored temporary shoring and in the reinforced zone for temporary MSE walls. Unless backfilling around culverts, use shoring backfill that meets the requirements of Class II Type I, Class III, Class V or Class VI select material in accordance with Section 1016 of the 2006 *Standard Specifications for Roads and Structures* or AASHTO M145 for soil classification A-2-4 with a maximum plasticity index (PI) of 6. For backfilling around culverts, use shoring backfill as defined herein except for A-2-4 soil.

(C) Non-anchored Temporary Shoring

Use steel shapes, plates and piles that meet the requirements of ASTM A36 and steel sheet piles that meet the requirements of Article 1084-2 of the *Standard Specifications*. Use timber lagging with a minimum allowable bending stress of 1000 psi that meets the requirements of Article 1082-1 of the 2006 *Standard Specifications for Roads and Structures*. For standard temporary shoring, use pile sections and lengths and lagging sizes as shown on the plans.

(D) Temporary MSE Walls

Use welded wire reinforcement forms, facings, mesh and mats that meet the requirements of AASHTO M55 or M221. Use connector bars and wires for welded wire wall components and support struts that meet the requirements of AASHTO M32. For standard temporary MSE walls, use wire gauges, strut sizes and welded wire components as shown on the plans.

(1) Geotextile Fabrics

Use geotextile fabrics that meet the requirements of Article 1056-1 of the 2006 *Standard Specifications for Roads and Structures*.

(a) Reinforcing Fabric

The reinforcement direction (RD) is defined as the direction perpendicular to the wall face and the cross-reinforcement direction (CRD) is defined as the direction parallel to the wall face.

Use woven polyester or polypropylene fabric that meets the following properties:

Property	Test Method	Requirement (MARV)
Wide Width Tensile Strength @ Ultimate (RD)	ASTM D4595	Varies – 200 lb / in min
Wide Width Tensile Strength @ Ultimate (CRD)	ASTM D4595	100 lb / in min
Trapezoidal Tear Strength	ASTM D4533	100 lb min
CBR Puncture Strength	ASTM D6241	600 lb min
UV Resistance after 500 hrs	ASTM D4355	70 %
Apparent Opening Size (AOS), US Sieve	ASTM D4751	20 min – 70 max
Permittivity	ASTM D4491	0.20 sec ⁻¹

For standard temporary MSE walls (temporary fabric wall) use reinforcing fabric wide width tensile strengths and lengths in the RD as shown on the plans.

(b) Retention Fabric

Retain shoring backfill at the face of temporary MSE walls with retention fabric. Use fabric that meets the requirements of Class 3 and the UV resistance, AOS and permittivity for separation geotextile in accordance with AASHTO M288.

(2) SierraScape Temporary Wall

Use uniaxial (UX) geogrids composed of high-density polyethylene (HDPE) manufactured by Tensar Earth Technologies. Test geogrids in accordance with ASTM D6637. Use connection rods manufactured by Tensar Earth Technologies to transfer the load between the facings and geogrids.

For standard temporary MSE walls (SierraScape temporary wall) use geogrid types and lengths as shown on the plans.

(3) Terratrel Temporary Wall

Use ribbed reinforcing steel strips manufactured by The Reinforced Earth Company that meet the requirements of ASTM A572, Grade 65. Use connector rods that meet the requirements of AASHTO M31, Grade 60 and hair pin connectors that meet the requirements of ASTM A1011, Grade 50. Use bolts, nuts and washers that meet the requirements of AASHTO M164.

For standard temporary MSE walls (Terratrel temporary wall) use ribbed steel strip size and lengths, rod lengths and diameters, hairpin connectors, bolts, nuts and washers as shown on the plans.

Embedment

“Embedment” is defined as the depth of shoring below the bottom of the excavation or the grade in front of the shoring. For cantilever shoring, embedment is the depth of the piling below the grade in front of the shoring. For temporary MSE walls, embedment is the difference between the grade elevation in front of the wall and the elevation of the bottom of the reinforced zone.

Portable Concrete Barriers

Provide portable concrete barriers in accordance with the plans and if shoring is located within the clear zone as defined in the *AASHTO Roadside Design Guide*. Use NCDOT portable concrete barriers (PCBs) in accordance with Roadway Standard Drawing No. 1170.01 and Section 1170 of the 2006 *Standard Specifications for Roads and Structures*. Use Oregon Tall F-Shape Concrete Barriers in accordance with detail drawing and special provision obtained from:

<http://www.ncdot.org/doh/preconstruct/wztc/DesRes/English/DesResEng.html>

The clear distance is defined as the horizontal distance from the back face of the barrier to the edge of pavement and the minimum required clear distance is shown on the traffic control plans. At the Contractor’s option or if the minimum required clear distance is not available, set an unanchored PCB against the traffic side of the shoring and design shoring for traffic impact or use the “surcharge case with traffic impact” for the standard temporary shoring. An anchored PCB or Oregon barrier is required for barriers above and behind temporary MSE walls.

Contractor Designed Shoring

“Contractor designed shoring” is defined as non-anchored temporary shoring or temporary MSE walls designed by the Contractor. Unless prohibited or required, Contractor designed shoring is optional. Contractor designed shoring is required when notes on plans prohibit the use of standard shoring. Non-anchored Contractor designed shoring is prohibited when notes on plans require the use of temporary MSE walls and Contractor designed temporary MSE walls are prohibited when notes on plans prohibit the use of temporary MSE walls.

Before beginning design, survey the shoring location to determine existing elevations and actual design heights. Submit design calculations and drawings including typical sections for review and acceptance showing details of the proposed design and construction sequence in accordance with Article 105-2 of the 2006 *Standard Specifications for Roads and Structures*. Have shoring designed, detailed and sealed by a Professional Engineer registered in the State of North Carolina. Submit 3 hard copies of design calculations and 10 hard copies of drawings and an electronic copy (pdf or jpeg format on CD or DVD) of both the calculations and drawings.

Design non-anchored temporary shoring in accordance with the *AASHTO Guide Design Specifications for Bridge Temporary Works* and temporary MSE walls in accordance with the

AASHTO Allowable Stress Design Standard Specifications for Highway Bridges. Use the following soil parameters for shoring backfill in the reinforced zone.

Total Unit Weight = 120 pcf

Friction Angle = 30 degrees

Cohesion = 0 psf

Design temporary shoring in accordance with the in-situ assumed soil parameters shown on the plans. Design shoring for a 3-year design service life and a traffic surcharge equal to 240 psf. This surcharge is not applicable for construction traffic. If a construction surcharge will be present within a horizontal distance equal to the height of the shoring, design the shoring for the required construction surcharge. If the edge of pavement or a structure to be protected is within a horizontal distance equal to the height of the shoring, design shoring for a maximum deflection of 3". Otherwise, design shoring for a maximum deflection of 6".

For non-anchored temporary shoring, the top of shoring elevation is defined as the elevation where the grade intersects the back face of the shoring. For traffic impact, apply 2 kips / ft to the shoring 1.5 ft above the top of shoring elevation. When designing for traffic impact, extend shoring at least 32" above the top of shoring elevation. Otherwise, extend shoring at least 6" above the top of shoring elevation.

Standard Shoring

Unless notes on plans prohibit the use of one or both types of standard shoring, standard shoring is optional. Submit a "Standard Temporary MSE Wall Selection Form" for each standard temporary MSE wall location and a "Standard Temporary Shoring Selection Form" for up to three standard temporary shoring locations. Submit selection forms at least 14 days before beginning shoring construction. Obtain standard shoring selection forms from:

<http://www.ncdot.org/doh/preconstruct/highway/geotech/formdet/standards.html>

(A) Standard Temporary Shoring

Determine the shoring height, traffic impact, groundwater condition and slope or surcharge case for each standard temporary shoring location. Determine the minimum required extension, embedment and sheet pile section modulus or H pile section from the plans for each location.

(B) Standard Temporary MSE Walls

Choose a standard temporary MSE wall from the multiple temporary MSE wall options shown in the plans. Do not use more than one option per wall location.

Step bottom of reinforced zone in increments equal to vertical reinforcement spacing for the wall option chosen. Determine the wall height and slope or surcharge case for each section of standard temporary MSE wall. With the exception of either the first or last section of wall, use horizontal section lengths in increments equal to the following for the wall option chosen.

Standard Temporary MSE Wall Option	Increment
Temporary Fabric Wall	9 ft min (varies)
Hilfiker Temporary Wall	10 ft min (varies)
SierraScape Temporary Wall	18 ft – 7 ¼ in
Retained Earth Temporary Wall	24 ft
Terratrel Temporary Wall	19 ft – 8 in

Determine the appropriate facings and/or forms and reinforcement length, spacing, strength, type, density and/or size from the plans for each wall section.

Construction Methods

When using an anchored PCB, anchor the barrier in accordance with Roadway Standard Drawing 1170.01 and Section 1170 of the 2006 *Standard Specifications for Roads and Structures*. Control drainage during construction in the vicinity of temporary shoring. Collect and direct run off away from temporary MSE walls, shoring and shoring backfill.

(A) Non-anchored Temporary Shoring

Install and interlock sheet piling or install piles as shown on the plans or accepted submittals with a tolerance of 1/2 inch per foot from vertical. Contact the Engineer if the design embedment is not achieved. If piles are placed in drilled holes, perform pile excavation to the required elevations and backfill excavations with concrete and lean sand grout.

Remove grout as necessary to install timber lagging. Install timber lagging with a minimum bearing distance of 3” on each pile flange. Backfill voids behind lagging with shoring backfill.

Perform welding in accordance with the accepted submittals and Article 1072-20 of the 2006 *Standard Specifications for Roads and Structures*.

(1) Pile Excavation

Excavate a hole with a diameter that will result in at least 3” of clearance around the entire pile. Use equipment of adequate capacity and capable of drilling through soil and non-soil including rock, boulders, debris, man-made objects and any other materials encountered. Blasting is not permitted to advance excavations. Blasting for core removal is permitted only when approved by the Engineer. Dispose of drilling spoils in accordance with Section 802 of the 2006 *Standard Specifications for Roads and Structures*. Drilling spoils consist of all excavated material including water removed from excavations by either pumping or drilling tools.

If unstable, caving or sloughing soils are encountered, stabilize excavations with clean watertight steel casing. Steel casings may be either sectional type or one continuous corrugated or non-corrugated piece. Provide casings of ample strength to withstand handling and driving stresses and the pressures imposed by concrete, earth or backfill. Use steel casings with an outside diameter equal to the hole size and a minimum wall thickness of 1/4 inch.

Before placing concrete, check the water inflow rate in the excavation after any pumps have been removed. If the inflow rate is less than 6" per half hour, remove any water and free fall the concrete into the excavation. Ensure that concrete flows completely around the pile. If the water inflow rate is greater than 6" per half hour, propose and obtain approval of the concrete placement procedure before placing concrete.

Center the pile in the excavation and fill the excavation with Class A concrete in accordance with Section 1000 of the 2006 *Standard Specifications for Roads and Structures* except as modified herein. Provide concrete with a slump of 6 to 8 inches. Use an approved high-range water reducer to achieve this slump. Place concrete in a continuous manner to the bottom of shoring or the elevations shown on the accepted submittals. Fill the remainder of the excavation with a lean sand grout and remove all casings.

(B) Temporary MSE Walls

The Engineer may require a wall preconstruction meeting to discuss the construction and inspection of the temporary MSE walls. If required, conduct the meeting with the Site Superintendent, the Resident or Bridge Maintenance Engineer, the Bridge Construction Engineer and the Geotechnical Operations Engineer before beginning wall construction.

Perform all necessary clearing and grubbing in accordance with Section 200 of the 2006 *Standard Specifications for Roads and Structures*. Excavate as necessary as shown on the plans or accepted submittals. Notify the Engineer when foundation excavation is complete. Do not place shoring backfill or first reinforcement layer until obtaining approval of the excavation depth and foundation material.

If applicable, install foundations located within the reinforced zone in accordance with the plans or accepted submittals.

Erect and maintain facings and forms as shown on the plans or accepted submittals. Stagger vertical joints of facings and forms to create a running bond when possible unless shown otherwise on the plans or accepted submittals.

Place facings and forms as near to vertical as possible with no negative batter. Construct temporary MSE walls with a vertical and horizontal tolerance of 3" when measured with a 10 ft straight edge and an overall vertical plumbness (batter) and horizontal alignment of less than 6".

Place reinforcement at locations and elevations shown on the plans or accepted submittals and in slight tension free of kinks, folds, wrinkles or creases. Repair or replace any damaged reinforcement. Contact the Engineer when existing or future structures such as foundations, pavements, pipes, inlets or utilities will interfere with reinforcement. To avoid structures, deflect, skew and modify reinforcement.

Do not splice reinforcement in the reinforcement direction (RD), i.e., parallel to the wall face. Seams are allowed in the cross-reinforcement direction (CRD). Bond or sew adjacent reinforcing fabric together or overlap fabric a minimum of 18" with seams oriented perpendicular to the wall face.

Place shoring backfill in 8 to 10 inch thick lifts and compact in accordance with Subarticle 235-4(C) of the 2006 *Standard Specifications for Roads and Structures*. Use only hand operated compaction equipment within 3 ft of the wall face. Do not damage reinforcement when placing and compacting shoring backfill. End dumping directly on the reinforcement is not permitted. Do not operate heavy equipment on reinforcement until it is covered with at least 10" of shoring backfill. Do not use sheepsfoot, grid rollers or other types of compaction equipment with feet.

Cover reinforcing and retention fabric with at least 3" of shoring backfill. Place top reinforcement layer between 4 and 24 inches below top of wall as shown on the plans or accepted submittals.

Bench temporary MSE walls into the sides of excavations where applicable. If the top of wall is within 5 ft of finished grade, remove top form or facing and incorporate the top reinforcement layer into the fill when placing fill in front of the wall. Temporary MSE walls remain in place permanently unless required otherwise.

CHANGEABLE MESSAGE SIGNS

(11-21-06)

DB11 R 11

Revise the 2006 *Standard Specifications for Roads and Structures* as follows:

Page 11-9, Article 1120-3, Replace the 3rd sentence with the following:

Sign operator will adjust flash rate so that no more than two messages will be displayed and be legible to a driver when approaching the sign at the posted speed.

PAVEMENT MARKING LINES

(11-21-06) (Rev. 08-17-10)

DB12 R01

Revise the 2006 *Standard Specifications* as follows:

Page 12-2, 1205-3(D) Time Limitations for Replacement, add the following at the beginning of the chart:

Facility Type	Marking Type	Replacement Deadline
Full-control-of-access multi-lane roadway (4 or more total lanes) and ramps, including Interstates	All markings including symbols	By the end of each workday's operation if the lane is opened to traffic

Page 12-5, 1205-3 (H) Observation Period, delete 1205-3 (H) and replace with the following:

Maintain responsibility for debonding and color of the pavement markings during a 12 month observation period beginning upon final acceptance of the project as defined under Article 105-17. Guarantee the markings under the payment and performance bond in accordance with Article 105-17.

During the 12 month observation period, provide pavement marking material that shows no signs of failure due to blistering, chipping, bleeding, discoloration, smearing or spreading under heat or poor adhesion to the pavement materials. Pavement markings that debond due to snowplowing will not be considered a failed marking. Replace, at no additional expense to the Department, any pavement markings that do not perform satisfactorily under traffic during the 12 month observation period.

Page 12-8, 1205-4 (C) Application, delete the last two sentences of the second paragraph and replace with the following:

Produce in place markings with minimum retroreflective values shown below, as obtained with a LTL 2000 Retroreflectometer or Department approved mobile retroreflectometer. Retroreflective measurements will be taken within 30 days after final placement of the pavement marking.

Page 12-9, 1205-4 (D) Observation Period, delete the entire section and replace with the following:

In addition to the requirements of Subarticle 1205-3(H), maintain responsibility for minimum retroreflective values for a 30-day period beginning upon the Engineer's acceptance of all markings on the project. Guarantee retroreflective values of the markings during the 30-day period under the payment and performance bond in accordance with Article 105-17.

Page 12-9, 1205-5 (B) Application, delete the second sentence of the fourth paragraph and replace with the following:

Produce in place markings with minimum retroreflective values shown below, as obtained with a LTL 2000 Retroreflectometer or Department approved mobile retroreflectometer. Retroreflective measurements will be taken within 30 days after final placement of the pavement marking.

Page 12-10, 1205-5 (C) Observation Period, delete this entire section and replace with the following:

Maintain responsibility for minimum retroreflective values for a 30-day period beginning upon satisfactory final placement of all markings on the project. Guarantee retroreflective values of the markings during the 30-day period under the payment and performance bond in accordance with Article 105-17.

Page 12-14, Article 1205-9, Maintenance, delete Article 1205-9 and replace with the following:

Replace pavement markings that prematurely deteriorate, fail to adhere to the pavement, lack reflectorization, or are otherwise unsatisfactory during the life of the project or during the 12 month observation period as determined by the Engineer at no cost to the Department.

Upon notification from the Engineer, winterize the project by placing an initial or additional application of paint pavement marking lines in accordance with Article 1205-8. Payment for *Paint Pavement Marking Lines* required to winterize the project will be made in accordance with Article 104-8(a).

EXCAVATION, TRENCHING, PIPE LAYING & BACKFILLING FOR UTILITIES

(02-17-09)

DB15 R001

Revise the *2006 Standard Specifications for Roads and Structures* as follows:

Page 15-5, Article 1505-4 Repair of Pavements, Sidewalks and Driveways, first paragraph, add at the end of the first sentence

in accordance with Section 848.

ON-THE-JOB TRAINING

(10-16-07) (Rev. 06-03-09)

Z-10

Description

The North Carolina Department of Transportation will administer a custom version of the Federal On-the-Job Training (OJT) Program, commonly referred to as the Alternate OJT Program. All contractors (existing and newcomers) will be automatically placed in the Alternate Program. Standard OJT requirements typically associated with individual projects will no longer be applied at the project level. Instead, these requirements will be applicable on an annual basis for each contractor administered by the OJT Program Manager.

On the Job Training shall meet the requirements of 23 CFR 230.107 (b), 23 USC – Section 140, this provision and the On-the-Job Training Program Manual.

The Alternate OJT Program will allow a contractor to train employees on Federal, State and privately funded projects located in North Carolina. However, priority must be given to training employees on NCDOT Federal-Aid funded projects.

Minorities and Women

Developing, training and upgrading of minorities and women toward journeymen level status is a primary objective of this special training provision. Accordingly, the Contractor shall make every effort to enroll minority and women as trainees to the extent that such persons are available within a reasonable area of recruitment. This training commitment is not intended, and shall not be used, to discriminate against any applicant for training, whether a member of a minority group or not.

Assessing Training Goals

The Department through the OJT Program Manager, will assign training goals for a calendar year based on the contractors' past three years' activity and the contractors' anticipated upcoming year's activity with the Department. At the beginning of each year, all contractors eligible will be contacted by the Department to determine the number of trainees that will be assigned for the upcoming calendar year. At that time, the Contractor shall enter into an agreement with the Department to provide a self-imposed on-the-job training program for the calendar year. This agreement will include a specific number of annual training goals agreed to by both parties. The number of training assignments may range from 1 to 15 per contractor per calendar year. The Contractor shall sign an agreement to fulfill their annual goal for the year. A sample agreement is available at www.ncdot.org/business/ocs/ojt/.

Training Classifications

The Contractor shall provide on-the-job training aimed at developing full journeyman level workers in the construction craft / operator positions. Preference shall be given to providing training in the following skilled work classifications:

Equipment Operators	Office Engineers
Truck Drivers	Estimators
Carpenters	Iron / Reinforcing Steel Workers
Concrete Finishers	Mechanics
Pipe Layers	Welders

The Department has established common training classifications and their respective training requirements that may be used by the contractors. However, the classifications established are not all-inclusive. Where the training is oriented toward construction applications, training will be allowed in lower-level management positions such as office engineers and estimators. Contractors shall submit new classifications for specific job functions that their employees are performing. The Department will review and recommend for acceptance to FHWA the new classifications proposed by contractors, if applicable. New classifications shall meet the following requirements:

Proposed training classifications are reasonable and realistic based on the job skill classification needs, and

The number of training hours specified in the training classification is consistent with common practices and provides enough time for the trainee to obtain journeyman level status.

The Contractor may allow trainees to be trained by a subcontractor provided that the Contractor retains primary responsibility for meeting the training and this provision is made applicable to the subcontract. However, only the Contractor will receive credit towards the annual goal for the trainee.

Where feasible, 25 percent of apprentices or trainees in each occupation shall be in their first year of apprenticeship or training. The number of trainees shall be distributed among the work classifications on the basis of the contractor's needs and the availability of journeymen in the various classifications within a reasonable area of recruitment.

No employee shall be employed as a trainee in any classification in which they have successfully completed a training course leading to journeyman level status or in which they have been employed as a journeyman.

Records and Reports

The Contractor shall maintain enrollment, monthly and completion reports documenting company compliance under these contract documents. These documents and any other information, as requested, shall be submitted to the OJT Program Manager.

Upon completion and graduation of the program, the Contractor shall provide each trainee with a certification Certificate showing the type and length of training satisfactorily completed.

Trainee Interviews

All trainees enrolled in the program shall receive an initial and Trainee / Post graduate interview conducted by the OJT program staff.

Trainee Wages

Contractors shall compensate trainees on a graduating pay scale based upon a percentage of the prevailing minimum journeyman wages (Davis-Bacon Act). Minimum pay shall be as follows:

60 percent	of the journeyman wage for the first half of the training period
75 percent	of the journeyman wage for the third quarter of the training period
90 percent	of the journeyman wage for the last quarter of the training period

In no instance shall a trainee be paid less than the local minimum wage. The Contractor shall adhere to the minimum hourly wage rate that will satisfy both the NCDOL and the Department.

Achieving or Failing to Meet Training Goals

The Contractor will be credited for each trainee employed by him on the contract work who is currently enrolled or becomes enrolled in an approved program and who receives training for at

least 50 percent of the specific program requirement. Trainees will be allowed to be transferred between projects if required by the Contractor's scheduled workload to meet training goals.

If a contractor fails to attain their training assignments for the calendar year, they may be taken off the NCDOT's Bidders List.

Measurement and Payment

No compensation will be made for providing required training in accordance with these contract documents.

STANDARD SPECIAL PROVISION**AVAILABILITY OF FUNDS – TERMINATION OF CONTRACTS**

(05-20-08)

Z-2

General Statute 143C-6-11. (h) Highway Appropriation is hereby incorporated verbatim in this contract as follows:

“(h) Amounts Encumbered – Transportation project appropriations may be encumbered in the amount of allotments made to the Department of Transportation by the Director for the estimated payments for transportation project contract work to be performed in the appropriation fiscal year. The allotments shall be multiyear allotments and shall be based on estimated revenues and shall be subject to the maximum contract authority contained in *General Statute 143C-6-11(c)*. Payment for transportation project work performed pursuant to contract in any fiscal year other than the current fiscal year is subject to appropriations by the General Assembly. Transportation project contracts shall contain a schedule of estimated completion progress, and any acceleration of this progress shall be subject to the approval of the Department of Transportation provided funds are available. The State reserves the right to terminate or suspend any transportation project contract, and any transportation project contract shall be so terminated or suspended if funds will not be available for payment of the work to be performed during that fiscal year pursuant to the contract. In the event of termination of any contract, the contractor shall be given a written notice of termination at least 60 days before completion of scheduled work for which funds are available. In the event of termination, the contractor shall be paid for the work already performed in accordance with the contract specifications.”

Payment will be made on any contract terminated pursuant to the special provision in accordance with Article 108-13(E), of the *North Carolina Department of Transportation Standard Specifications for Roads and Structures*, dated July 1, 2006 and as amended by the Standard Special Provision, Division One found elsewhere in this RFP.

***** STANDARD SPECIAL PROVISIONS *******NCDOT GENERAL SEED SPECIFICATIONS FOR SEED QUALITY**

(11-18-08)

Z-3

Seed shall be sampled and tested by the North Carolina Department of Agriculture and Consumer Services, Seed Testing Laboratory. When said samples are collected, the vendor shall supply an independent laboratory report for each lot to be tested. Results from seed so sampled shall be final. Seed not meeting the specifications shall be rejected by the Department of Transportation and shall not be delivered to North Carolina Department of Transportation warehouses. If seed has been delivered it shall be available for pickup and replacement at the supplier's expense.

Any re-labeling required by the North Carolina Department of Agriculture and Consumer Services, Seed Testing Laboratory, that would cause the label to reflect as otherwise specified herein shall be rejected by the North Carolina Department of Transportation.

Seed shall be free from seeds of the noxious weeds Johnsongrass, Balloonvine, Jimsonweed, Witchweed, Itchgrass, Serrated Tussock, Showy Crotalaria, Smooth Crotalaria, Sicklepod, Sandbur, Wild Onion, and Wild Garlic. Seed shall not be labeled with the above weed species on the seed analysis label. Tolerances as applied by the Association of Official Seed Analysts will NOT be allowed for the above noxious weeds except for Wild Onion and Wild Garlic.

Tolerances established by the Association of Official Seed Analysts will generally be recognized. However, for the purpose of figuring pure live seed, the found pure seed and found germination percentages as reported by the North Carolina Department of Agriculture and Consumer Services, Seed Testing Laboratory will be used. Allowances, as established by the NCDOT, will be recognized for minimum pure live seed as listed on the following pages.

The specifications for restricted noxious weed seed refers to the number per pound as follows:

<u>Restricted Noxious Weed</u>	<u>Limitations per Lb. Of Seed</u>	<u>Restricted Noxious Weed</u>	<u>Limitations per Lb. of Seed</u>
Blessed Thistle	4 seeds	Cornflower (Ragged Robin)	27 seeds
Cocklebur	4 seeds	Texas Panicum	27 seeds
Spurred Anoda	4 seeds	Bracted Plantain	54 seeds
Velvetleaf	4 seeds	Buckhorn Plantain	54 seeds
Morning-glory	8 seeds	Broadleaf Dock	54 seeds
Corn Cockle	10 seeds	Curly Dock	54 seeds
Wild Radish	12 seeds	Dodder	54 seeds
Purple Nutsedge	27 seeds	Giant Foxtail	54 seeds
Yellow Nutsedge	27 seeds	Horsenettle	54 seeds
Canada Thistle	27 seeds	Quackgrass	54 seeds
Field Bindweed	27 seeds	Wild Mustard	54 seeds
Hedge Bindweed	27 seeds		

Seed of Pensacola Bahiagrass shall not contain more than 7% inert matter, Kentucky Bluegrass, Centipede and Fine or Hard Fescue shall not contain more than 5% inert matter whereas a maximum of 2% inert matter will be allowed on all other kinds of seed. In addition, all seed

shall not contain more than 2% other crop seed nor more than 1% total weed seed. The germination rate as tested by the North Carolina Department of Agriculture shall not fall below 70%, which includes both dormant and hard seed. Seed shall be labeled with not more than 7%, 5% or 2% inert matter (according to above specifications), 2% other crop seed and 1% total weed seed.

Exceptions may be made for minimum pure live seed allowances when cases of seed variety shortages are verified. Pure live seed percentages will be applied in a verified shortage situation. Those purchase orders of deficient seed lots will be credited with the percentage that the seed is deficient.

FURTHER SPECIFICATIONS FOR EACH SEED GROUP ARE GIVEN BELOW:

Minimum 85% pure live seed; maximum 1% total weed seed; maximum 2% total other crop seed; maximum 144 restricted noxious weed seed per pound. Seed less than 83% pure live seed will not be approved.

Sericea Lespedeza
Oats (seeds)

Minimum 80% pure live seed; maximum 1% total weed seed; maximum 2% total other crop; maximum 144 restricted noxious weed seed per pound. Seed less than 78% pure live seed will not be approved.

Tall Fescue (all approved varieties)	Bermudagrass
Kobe Lespedeza	Browntop Millet
Korean Lespedeza	German Millet - Strain R
Weeping Lovegrass	Clover - Red/White/Crimson
Carpetgrass	

Minimum 78% pure live seed; maximum 1% total weed seed; maximum 2% total other crop seed; maximum 144 restricted noxious weed seed per pound. Seed less than 76% pure live seed will not be approved.

Common or Sweet Sundangrass

Minimum 76% pure live seed; maximum 1% total weed seed; maximum 2% total other crop seed; maximum 144 restricted noxious weed seed per pound. Seed less than 74% pure live seed will not be approved.

Rye (grain; all varieties)
Kentucky Bluegrass (all approved varieties)
Hard Fescue (all approved varieties)
Shrub (bicolor) Lespedeza

Minimum 70% pure live seed; maximum 1% total weed seed; maximum 2% total other crop seed; maximum 144 restricted noxious weed seed per pound. Seed less than 70% pure live seed will not be approved.

Centipedegrass

Crownvetch

Pensacola Bahiagrass

Japanese Millet

Reed Canary Grass

Zoysia

Minimum 70% pure live seed; maximum 1% total weed seed; maximum 2% total other crop seed; maximum 5% inert matter; maximum 144 restricted noxious weed seed per pound.

Barnyard Grass

Big Bluestem

Little Bluestem

Bristly Locust

Birdsfoot Trefoil

Indiangrass

Orchardgrass

Switchgrass

Yellow Blossom Sweet Clover

***** STANDARD SPECIAL PROVISIONS *****

ERRATA

(07-21-09)

Z-4

Revise the *Standard Specifications for Roads and Structures July 2006* on all projects as follows:

Division 1

- Page 1-1, replace AREA - American Railway Engineering Association with ***American Railway Engineering and Maintenance of Way Association***.
- Page 1-7, remove **-L-** in middle of page after INVITATION TO BID and before LABORATORY.
- Page 1-25, 102-16(R), move 2nd paragraph to left margin. It is not a part of this subarticle, but part of the entire article.

Division 2

- Page 2-9, Subarticle 225-1(C), 1st paragraph, 2nd line, last word, add a “d” to make the word grade become **graded**
- Page 2-15, Subarticle 226-3, 5th paragraph, first line, replace the word *in* with the word *is*.
- Page 2-23, Subarticle 235-4(B)(9), at the end of the sentence, replace finished greater with finished **grade**.
- Page 2-28, Article 260-3, First paragraph, second line, remove the word *foot*.

Division 3

- Page 3-13, Article 340-4, Second paragraph, change Flowable Backfill to Flowable **Fill**

Division 4

- Page 4-29, Article 420-13(A) Description, change reference from Section 1082 to **Article 1081-6**.
- Page 4-40, Subarticle 420-17(F) first line, change Subarticle 420-17(B) to **(B) herein**.
- Page 4-70, 442-13(B) Second sentence, change SSPC Guide 6I to SSPC Guide **6**.
- Pages 4-72, 4-74, 4-76, at the top of the page, substitute the heading Section 452 with Section **450**.
- Page 4-79, at the top of the page, substitute the heading Section 450 with Section **452**
- Page 4-80, change 452-7 to 452-**6** at the top of the page.
- Page 4-80, change Pay Item ___Steel Pile Retaining Walls, to **Sheet** Pile Retaining Walls.
- Page 4-88, 462-4, Title, Replace last word Measurement with the word **PAYMENT**

Division 5

- Page 5-8, Article 501-15 Measurement and Payment, delete the 4th paragraph that begins The quantity of lime, measured as provided ...

- Page 5-14, Article 520-11 Measurement and Payment, first paragraph, second line, delete *will be*.

Division 6

- Page 6-3, Article 600-9, 2nd Paragraph on this page, replace 818-5 with 818-4.
- Pages 6-30 and 31, Subarticle 610-3(A)(13) Move 2 paragraphs from the margin to the right under the number (13).
- Page 6-43, Article 610-8, 4th paragraph, remove the first *the*
- Page 6-44, 2nd full paragraph, 1st sentence, delete the first *and* and add *transverse* just before cross-slope control.
- Page 6-51, at the top of the page, add **610-14** on the same line, and just before the heading MAINTENANCE.
- Page 6-53, Article 620-4 sixth paragraph, second line; the word that should be *which*.
- Page 6-66, title, Replace EXISTNG with **EXISTING**
- Page 6-66, Article 657-1, Description, first sentence, replace PS/AR (hot-poured rubber asphalt with *hot applied joint sealer*.
- Page 6-66, Article 657-2, replace PS/AR (Hot-Poured Rubber Asphalt with the following:

Item	Section
<i>Hot Applied Joint Sealer</i>	<i>1028-2</i>

- Page 6-67, at the top of the page, substitute the heading Section 654 with Section **657**.
- Page 6-67, Article 657-3 Construction Methods, 2nd paragraph, replace PS/AR sealant with *hot applied joint sealer*.
- Page 6-67, at the top of the page, substitute the heading Section 654 with Section **657**.
- Page 6-71, 660-9(B)(1), Replace the first sentence of the first paragraph with the following:

Using the quantities shown in *Table 660-1*, apply asphalt material to the existing surface followed by an application of No. 78 M or lightweight aggregate.

- Page 6-89, Add a period at the end of the last sentence at the bottom of the page.
- Page 6-90, Article 663-5, first paragraph, first sentence, change 50oF to **50°F**; third paragraph, fourth sentence change 325oF to **325°F**.

Division 7

- Page 7-12, at the top of the page, substitute the heading Section 710 with Section **700**.
- Page 7-15, Article 710-9, 4th paragraph, last line, change 710-11(B) to 710-10(B).

Division 8

- Page 8-13, Article 808-3, 4th Paragraph, third line, replace the word Eexcavation with the word **Excavation**
- Page 8-35, Article 848-2, Item: Replace Cncrete with **Concrete**

Division 9

- Page 9-2, add **901-3** just before CONSTRUCTION METHODS

Division 10

- Page 10-12, near bottom of page add (C) before Proportioning and Mixing of Modified Compositions, which should be bold type.
- Page 10-28, at the top of the page, substitute Section 100**6** for 1005.
- Page 10-54, Subarticle 1018-2A), First line, substitute (B) for II, third line, substitute (B)(2) for II-b.
- Pages 10-56, 10-58, 10-60 at the top of the page, substitute Section 1018 with Section **1020**.
- Page 10-84, Table 1042-1, Class 2, Maximum, change from 23r to **23**.
- Page 10-84, Article 1042-2 Testing, last sentence, replace the word alterations with the word **cycles**.
- Page 10-100, Table 1056-1, replace on the line for Trapezoidal Tear Strength:

Type 1	Type 2	Type 3		Type 4
		Class A	Class B	Soil Stabilization
45 lb	75 lb	--	--	75 lb

- Page 10-116, Subarticle 1070-10, first paragraph, second sentence, add **or** just before cold-forged sleeve.
- Pages 10-136 through 10-147, at the top of the page, substitute Section 1074 with Section **1072**.
- Page 10-157, Article 1077-11, first paragraph, change the reference from Subarticle 420-18(B) to Subarticle 420-**17**(B).
- Page 10-200, Subarticle 1080-14(B), change reference to ASTM D335**9**
- Page 10-211, at the top of the page, substitute Section 1081 with Section **1082**.
- Page 10-229, add **1088-6 BLANK** on the line above 1088-7 TUBULAR MARKERS.
- Page 10-244, add **1089-10 BLANK** and **1089-11 BLANK** on the lines just above 1089-12 FLAGGER.
- Page 10-272, delete Article 1098-6 in its entirety. Renumber Articles 1098-7 through 1098-17 as Articles 1098-6 through 1098-16 consecutively.

Division 12

- Page 12-21 Add **1266-2** just before the heading MATERIALS.

Division 14

- Page 14-33, Article 1413-6, first paragraph, first sentence, first line, replace the word made with the words *paid for*.

Division 15

- Page 15-2 add **1500-4** just before the heading WEEKEND, NIGHT AND HOLIDAY WORK.
- Page 15-4, Subarticle 1505-3(A)(2), replace the 2nd line with the following: *Provide shielding or shoring as required under Section 150 or as required elsewhere in the contract.*
- Page 15-5, add **1505-6** on the same line and just before the heading MEASUREMENT AND PAYMENT. (Remove the period after PAYMENT.)
- Page 15-6, Article 1505-6(3), delete *in Section 1175* and replace it with *elsewhere in the contract*.
- Page 15-8, add **1510-4** on the same line and just before the heading MEASUREMENT AND PAYMENT.
- Page 15-10, substitute **BLANK** for CONSTRUCTION REQUIREMENTS on the same line and just before 1515-4.
- Page 15-10, substitute **CONSTRUCTION REQUIREMENTS** for General Requirements
- Page 15-10, Article 1515-4, add **(D)** just before the bolded Fire Hydrants.
- Page 15-13, Article 1520-3, 8th paragraph, add *pipe* after diameter.
- Page 15-22, add **1540-3** on the same line and just before the heading CONSTRUCTION REQUIREMENTS
- Page 15-28, Replace 1550-6 METHOD OF MEASUREMENT with **MEASUREMENT AND PAYMENT**.

Division 16

- Page 16-12, Subarticle 1632-1(C) ¼ Inch hardware cloth, change the minimum width from 24 inches to **48** inches.

Division 17

- Page 17-19, Subarticle 1725-2 Material, Second paragraph, change Article 1098-7 to 1098-8
- Page 17-20, Subarticle 1726-2 Material, Second paragraph, change Article 1098-8 to 1098-9

END

MINIMUM WAGES

(07-21-09)

Z-5

FEDERAL: The Fair Labor Standards Act provides that with certain exceptions every employer must pay wages at the rate of not less than SEVEN DOLLARS AND TWENTY FIVE CENTS (\$7.25) per hour.

STATE: The North Carolina Minimum Wage Act provides that every employer shall pay to each of his employees wages at a rate of not less than SEVEN DOLLARS AND TWENTY FIVE CENTS (\$7.25) per hour.

The minimum wage paid to all skilled labor employed on this contract shall be SEVEN DOLLARS AND TWENTY FIVE CENTS (\$7.25) per hour.

The minimum wage paid to all intermediate labor employed on this contract shall be SEVEN DOLLARS AND TWENTY FIVE CENTS (\$7.25) per hour.

The minimum wage paid to all unskilled labor on this contract shall be SEVEN DOLLARS AND TWENTY FIVE CENTS (\$7.25) per hour.

The determination of the intent of the application of these Acts to the project's contract shall be the Design-Build Team's responsibility.

The Design-Build Team shall have no claim against the Department of Transportation for any changes in the minimum wage laws, State or Federal. It is the responsibility of the Design-Build Team to be fully informed of all Federal and State Laws affecting the project's contract.

***** STANDARD SPECIAL PROVISIONS *****

(03-17-10)

DIVISION ONE OF STANDARD SPECIFICATIONS

Division One of the 2006 NCDOT Standard Specifications for Roads and Structures (Standard Specifications) shall apply except as follows:

Definitions: Throughout Division One of the *Standard Specifications*, the term “Contractor” is replaced with “Design-Build Team”, the term “Bidder” is replaced with “Proposer,” the term “Bid” is replaced by “Price Proposal,” and the phrase “lowest Responsible Bidder” is replaced with “responsible Proposer with the lowest adjusted price.” The replacement of “Contractor” with “Design-Build Team” does not apply to Article 102-2. The replacement of the above terms also does not apply when the terms are part of a phrase (e.g. bid bond, prime contractor, total amount bid, etc.)

Deletions: Articles 102-4, 102-10(C)(2), 102-11(A), 103-2(B), 103-4(B), 104-13, and 108-2 of the *Standard Specifications* are deleted from Design-Build Contracts.

Modifications: The remainder of this Standard Special Provision includes modifications to Division One of the *Standard Specifications*.

SECTION 101 DEFINITION OF TERMS

Page 1-2, Article 101-3, replace and add certain definitions as follows:

ADDITIONAL WORK

Additional work is that which results from a change or alteration in the contract and for which there are contract unit prices in the original contract or an executed supplemental agreement.

ADVERTISEMENT

The public advertisement inviting Statements of Qualifications for the design and construction of specific projects.

AWARD

The decision of the Board of Transportation to accept the proposal of the selected Design-Build Team for work which is subject to the furnishing of payment and performance bonds, and such other conditions as may be otherwise provided by law, the Request for Proposals, and the *Standard Specifications*.

CONTRACT

The executed agreement between the Department of Transportation and the successful proposer, covering the performance of the work and the compensation therefor.

The term contract is all inclusive with reference to all written agreements affecting a contractual relationship and all documents referred to therein. The contract shall specifically

include, but not be limited to, the Request for Proposals, the Technical Proposal, the Price Proposal, the printed contract form and all attachments thereto, the contract bonds, the plans and associated special provisions prepared by the Design-Build Team, the standard specifications and all supplemental specifications thereto, the standard special provisions and the project special provisions contained in the Request for Proposals, and all executed supplemental agreements, all of which shall constitute one instrument.

DATE OF AVAILABILITY

That date set forth in the Request for Proposals, by which it is anticipated that the Contract will be executed and sufficient design efforts or work sites within the project limits will be available for the Design-Build Team to begin his controlling operations or design.

DESIGN-BUILD

A form of contracting in which the successful proposer undertakes responsibility for both the design and construction of a project.

DESIGN-BUILD TEAM

An individual, partnership, joint venture, corporation or other legal entity that furnishes the necessary design and construction services, whether by itself or through subcontracts.

DESIGN-BUILD PROPOSAL

A proposal to contract consisting of a separately sealed Technical Proposal and a separately sealed Price Proposal submitted in response to a Request for Proposals on a Design-Build project.

PLANS

The project plans, Standard Drawings, working drawings and supplemental drawings, or reproductions thereof, accepted by the Engineer, which show the location, character, dimensions and details of the work to be performed.

(A) Standard Drawings:

Drawings approved for repetitive use, showing details to be used where appropriate. All Standard Drawings approved by the Department plus subsequent revisions and additions. Standard Drawings are available for purchase from:

Randy A. Garris, PE
State Contract Officer
1591 Mail Service Center
Raleigh, NC 27699-1591

(B) Preliminary Plans:

Department-furnished drawings included along with a Request for Proposals, or as developed by the Design-Build Team.

(C) Project Plans:

Construction drawings prepared, sealed and completed by the Design-Build Team, or as provided by the Department, that contain specific details and dimensions peculiar to the work.

(D) Working Drawings and Supplemental Drawings:

Supplemental design sheets, shop drawings, or similar data which the Design-Build Team is required to submit to the Engineer.

(E) As-Constructed Drawings:

Final drawings prepared by the Design-Build Team, documenting the details and dimensions of the completed work.

PRICE PROPOSAL

The offer of a Proposer, submitted on the prescribed forms, to perform the work and furnish the labor and materials at the price quoted.

PROPOSAL (OR REQUEST FOR PROPOSALS)

The paper document provided by the Department that the proposer uses to develop his paper offer to perform the work at designated bid prices.

PROPOSER

An individual, partnership, firm, corporation, LLC, or joint venture formally submitting a Technical Proposal and Price Proposal in response to a Request for Proposals.

RIGHT OF WAY

The land area shown on the plans as right of way within which the project is to be constructed.

SCHEDULE OF VALUES

A schedule of work items necessary to complete work, along with the progress of each work item, primarily for the purpose of partial payments.

TABLE OF QUANTITIES

A listing of work items (corresponding to the items in the Trns*port pay item list) that contributes to a project completion. The table shall include estimated quantities for each work item.

TECHNICAL PROPOSAL

A submittal from a proposer, in accordance with requirements of the Request for Proposals, for the purpose of final selection. The Technical Proposal is defined to also include any supplemental information requested by the Department from a proposer prior to opening bids.

SECTION 102 PROPOSAL REQUIREMENTS AND CONDITIONS

Page 1-11, delete Article 102-1 and replace with the following:

102-1 INVITATION TO BID

After the advertisement has been made, an invitation to bid will be mailed to known prequalified contractors and any other contracting firms, material suppliers, and other interested parties who have requested they be placed on the invitation to bid mailing list informing them that bids will be received for the construction of specific projects. Such invitation will indicate the contract identification number, length, locations, and descriptions; a general summary of the items of work to be performed; and information on how to receive a Request for Qualifications.

All projects will be advertised in daily newspapers throughout the state prior to the bid opening.

Page 1-15, delete Article 102-3 and replace with the following:

102-3 CONTENTS OF REQUEST FOR PROPOSALS

A Request for Proposals will be furnished by the Department to the selected proposers from among the respondents to the Request for Qualifications. Each Request for Proposals will be marked on the front cover by the Department with an identifier of the Proposer to whom it is being furnished. This Request for Proposals will state the location of the project and will show a schedule of contract items for which Technical and Price Proposals are invited. It will set forth the date and time Technical and Price Proposals are to be submitted and will be opened. The Request for Proposals will also include any special provisions or requirements that vary from or are not contained in any preliminary design information or standard specifications.

The Request for Proposals will also include the printed contract forms and signature sheets for execution by both parties to the contract. In the event the Proposer is awarded the contract, execution of the Request for Proposals by the Proposer is considered the same as execution of the contract.

Standard specifications, sealed plans specifically identified as the Department's responsibility and other documents designated in the Request for Proposals shall be considered a part of the Request for Proposals whether or not they are attached thereto. All papers bound with the proposal are necessary parts thereof and shall not be detached, taken apart, or altered.

The names and identity of each prospective Proposer that receives a copy of the Request for Qualifications for the purposes of submitting a Statement of Qualifications shall be made public, except that a potential Proposer who obtains a Request for Qualifications may, at the time of ordering, request that his name remain confidential.

Up to three copies of the Request for Proposals will be furnished to each prospective Proposer. Additional copies may be purchased for the sum of \$25 each. The copy marked with the Proposer's name and prequalification number shall be returned to the Department.

Page 1-16, Article 102-6, replace the first paragraph with the following:

The Proposer shall examine carefully the site of the work contemplated, the preliminary plans and specifications, and the Request for Proposals. The submission of a Technical Proposal and a Price Proposal shall be conclusive evidence that the Proposer has investigated and is satisfied as to the conditions to be encountered; as to the character, quality, and scope of work to be performed; the quantities of materials to be furnished; and as to the conditions and requirements of the proposed contract.

Page 1-17, delete Article 102-7 and replace with following:**102-7 SUBSURFACE INVESTIGATION REPORT**

The Subsurface Investigation and report was made for the purpose of information only.

If a subsurface investigation report is available on this project, a copy may be obtained by the prospective proposers upon request.

The subsurface investigation on which the report is based was made for the purpose of information only. The various field boring logs, rock cores, and soil test data available may be reviewed or inspected in Raleigh at the office of the Geotechnical Unit. Neither the subsurface investigation report nor the field boring logs, rock cores, or soil test data is part of the contract.

General soil and rock strata descriptions and indicated boundaries are based on a geotechnical interpretation of all available subsurface data and may not necessarily reflect the actual subsurface conditions between borings or between sampled strata within the borehole. The laboratory sample data and the in situ (in-place) test data can be relied on only to the degree of reliability inherent in the standard test method. The observed water levels or soil moisture conditions indicated in the subsurface investigations are as recorded at the time of the investigation. These water levels or soil moisture conditions may vary considerably with time according to climatic conditions including temperature, precipitation, and wind, as well as other nonclimatic factors.

The Proposer is cautioned that details shown in the subsurface investigation report are preliminary only. The Department does not warrant or guarantee the sufficiency or accuracy of the investigation made, nor the interpretations made or opinions of the Department as to the type of materials and conditions that may be encountered. The proposer is cautioned to make such independent subsurface investigations, as he deems necessary to satisfy himself as to conditions to be encountered on this project. The Design-Build Team shall have no claim for additional compensation or for an extension of time for any reason resulting from the actual conditions encountered at the site differing from those indicated in the subsurface investigation.

Pages 1-17, delete Article 102-8 and replace with the following:**102-8 PREPARATION AND SUBMISSION OF BIDS**

All Price Proposals shall be prepared and submitted in accordance with the following requirements:

1. The Request for Proposals provided by the Department shall be used and shall not be taken apart or altered. The Price Proposal shall be submitted on the same form, which has

been furnished to the Proposer by the Department as identified by the Proposer's name marked on the front cover by the Department.

2. All entries including signatures shall be written in ink.
3. The Proposer shall submit a lump sum or unit price for every item in the Price Proposal. The lump sum or unit prices bid for the various contract items shall be written in figures.
4. An amount bid shall be entered in the Request for Proposals for every item and the price shall be written in figures in the "Amount Bid" column in the Request for Proposals.
5. The total amount bid shall be written in figures in the proper place in the Request for Proposals. The total amount bid shall be determined by adding the amounts bid for each lump sum item.
6. Changes in any entry shall be made by marking through the entry in ink and making the correct entry adjacent thereto in ink. A representative of the Proposer shall initial the change in ink.
7. The Price Proposal shall be properly executed. In order to constitute proper execution, the Price Proposal shall be executed in strict compliance with the following:
 - a. If a Price Proposal is by an individual, it shall show the name of the individual and shall be signed by the individual with the word "Individually" appearing under the signature. If the individual operates under a firm name, the bid shall be signed in the name of the individual doing business under the firm name.
 - b. If the Price Proposal is by a corporation, it shall be executed in the name of the corporation by the President, Vice President, or Assistant Vice President. It shall be attested by the Secretary or Assistant Secretary. The seal of the corporation shall be affixed. If the Price Proposal is executed on behalf of a corporation in any other manner than as above, a certified copy of the minutes of the Board of Directors of said corporation authorizing the manner and style of execution and the authority of the person executing shall be attached to the Price Proposal or shall be on file with the Department.
 - c. If the Price Proposal is made by a partnership, it shall be executed in the name of the partnership by one of the general partners.
 - d. If the Price Proposal is made by a Limited Liability Company (LLC), it shall be signed by the manager and notarized.
 - e. If the Price Proposal is made by a joint venture, it shall be executed by each of the joint venturers in the appropriate manner set out above. In addition, the execution by the joint venturers shall appear below their names.
 - f. The Price Proposal execution shall be notarized by a notary public whose commission is in effect on the date of execution. Such notarization shall be applicable both to the Price Proposal and to the non-collusion affidavit which is part of the signature sheets.
8. The Price Proposal shall not contain any unauthorized additions, deletions, or conditional bids.

9. The Proposer shall not add any provision reserving the right to accept or reject an award, or to enter into a contract pursuant to an award.
10. The Price Proposal shall be accompanied by a bid bond on the form furnished by the Department or by a bid deposit. The bid bond shall be completely and properly executed in accordance with the requirements of Article 102-11. The bid deposit shall be a certified check or cashier check in accordance with Article 102-11.
11. The Price Proposal shall be placed in a sealed envelope and shall have been delivered to and received by the Department prior to the time specified in the Request for Proposals.

Page 1-21, Article 102-11, delete the third paragraph and replace with the following:

No bid will be considered or accepted unless accompanied by one of the foregoing securities. The bid bond shall be executed by a Corporate Surety licensed to do business in North Carolina and the certified check or cashiers check shall be drawn on a bank or trust company insured by the Federal Deposit Insurance Corporation and made payable to the Department of Transportation in an amount of at least 5% of the total amount bid for the contract. The condition of the bid bond or bid deposit is: the Principal shall not withdraw its bid within 75 days after the submittal of the same, and if the Board of Transportation shall award a contract to the Principal, the Principal shall within 14 calendar days after the notice of award is received by him give, payment and performance bonds with good and sufficient surety as required for the faithful performance of the contract and for the protection of all persons supplying labor and materials in the prosecution of the work; in the event of the failure of the Principal to give such payment and performance bonds as required, then the amount of the bid bond shall be immediately paid to the Department as liquidated damages, or, in the case of a bid deposit, the deposit shall be forfeited to the Department.

Page 1-22, delete Article 102-12 and replace with the following:

102-12 DELIVERY OF BIDS

All Price Proposals shall be placed in a sealed envelope having the name and address of the Proposer, and the statement " Price Proposal for the Design/Build of State Highway Project No. _____ in _____ County(ies)" on the outside of the envelope. If delivered by mail, the sealed envelope shall be placed in another sealed envelope and the outer envelope addressed to the Contract Officer as stated in the Request for Proposals. The outer envelope shall also bear the statement "Price Proposal for the Design/Build of State Highway Project No. _____". All Technical Proposals shall be placed in a sealed envelope having the name and address of the Proposer, and the statement "Technical Proposal for the Design/Build of State Highway Project No. _____ in _____ County(ies)" on the outside of the envelope. If delivered by mail, the sealed envelope shall be placed in another sealed envelope and the outer envelope addressed to the Contract Officer as stated in the Request for Proposal. The outer envelope shall also bear the statement "Technical Proposal for the Design/Build of State Highway Project No. _____". If delivered in person on or before the due date, the sealed envelope shall be delivered to the office of the Contract Officer as indicated in the Request for Proposals. Price Proposals and Technical Proposals shall be submitted in accordance with the project special provision "Submittal of Proposals" contained elsewhere in this Request for Proposals.

All Price Proposals and Technical Proposals shall be delivered prior to the time specified in the Request for Proposals. Price proposals and Technical Proposals received after such time will not be accepted and will be returned to the Proposer unopened.

Pages 1-22, delete Article 102-13 and replace with the following:

102-13 WITHDRAWAL OR REVISION OF BIDS

A Design-Build Team will not be permitted to withdraw its Technical and Price Proposals after they have been submitted to the Department, unless allowed under Article 103-3 or unless otherwise approved by the State Highway Administrator.

Page 1-23, delete Article 102-14 and replace with the following:

102-14 RECEIPT AND OPENING OF BIDS

Price Proposals will be opened and read publicly at the time and place indicated in the Request for Proposals. The scores of the previously conducted evaluation of the Technical Proposals will also be read publicly in accordance with the procedures outlined in the Request for Proposals. Proposers, their authorized agents, and other interested parties are invited to be present.

Page 1-23, Article 102-15, Replace the 1st paragraph with the following:

102-15 REJECTION OF BIDS

Any Price Proposal submitted which fails to comply with any of the requirements of Articles 102-8, 102-10 or 102-11, or with the requirements of the project scope and functional specifications shall be considered irregular and may be rejected. A Price Proposal that does not contain costs for all proposal items shall be considered irregular and may be rejected.

**SECTION 103
AWARD AND EXECUTION OF CONTRACT**

Page 1-25, delete Article 103-1 and replace with the following:

103-1 CONSIDERATION OF PRICE PROPOSALS

After the Price Proposals are opened and read, they will be tabulated. The Price Proposal and score of the Technical Proposal will be made available in accordance with procedures outlined in the Request for Proposals. In the event of errors, omissions, or discrepancies in the costs, corrections to the Price Proposal will be made in accordance with the provisions of Article 103-2. Such corrected costs will be used to determine the lowest adjusted price.

After the reading of the Price Proposals and technical scores, the Department will calculate the lowest adjusted price as described in the "Selection Procedure" section of the Request for Proposals.

The right is reserved to reject any or all Price Proposals, to waive technicalities, to request the Proposer with the lowest adjusted price to submit an up-to-date financial and operating

statement, to advertise for new proposals, or to proceed to do the work otherwise, if in the judgment of the Board, the best interests of the State will be promoted thereby.

Page 1-26, Subarticle 103-2(A), add items (7) and (8) as follows:

(7) Discrepancy in the “Total Amount Bid” and the addition of the “Amount Bid” for each line Item

In the case of the Total Amount Bid does not equal the summation of each Amount Bid for the line items, the summation of each Amount Bid for the line items shall be deemed to be the correct total for the entire project.

(8) Omitted Total Amount Bid –Amount Bid Completed

If the Total Amount Bid is not completed and the Amount Bid for all line items is completed the Total Amount Bid shall be the summation of the Amount Bid for all line items.

Page 1-28, Subarticle 103-4(A), replace the fourth sentence with the following:

The notice of award, if the award be made, will be issued within 75 days after the submittal of bids, except that with the consent of the lowest responsible bidder the decision to award the contract to such bidder may be delayed for as long a time as may be agreed upon by the Department and such bidder.

Page 1-29, delete Article 103-6 and replace with the following:

103-6 RETURN OF BID BOND OR BID DEPOSIT

Checks that have been furnished as a bid deposit will be retained until after the contract bonds have been furnished by the successful proposer, at which time Department of Transportation warrants in the equivalent amount of checks that were furnished as a bid deposit will be issued.

Paper bid bonds will be retained by the Department until the contract bonds are furnished by the successful proposer, after which all such bid bonds will be destroyed unless the individual bid bond form contains a note requesting that it be returned to the proposer or the Surety.

Page 1-30, delete Article 103-9 and replace with the following:

103-9 FAILURE TO FURNISH CONTRACT BONDS

The successful proposer's failure to file acceptable bonds within 14 calendar days after the notice of award is received by him shall be just cause for the forfeiture of the bid bond or bid deposit and rescinding the award of the contract. Award may then be made to the responsible proposer with the next lowest adjusted price or the work may be readvertised and constructed under contract or otherwise, as the Board of Transportation may decide.

SECTION 104 SCOPE OF WORK

Page 1-30, delete Article 104-1 and replace with the following:

104-1 INTENT OF CONTRACT

The intent of the contract is to prescribe the work or improvements that the Design-Build Team undertakes to perform, in full compliance with the contract. In case the method or character of any part of the work is not covered by the contract, this section shall apply. The Design-Build Team shall perform all work in accordance with the contract or as may be modified by written orders, and shall do such special, additional, extra, and incidental work as may be considered necessary to complete the work to the full intent of the contract. Unless otherwise provided elsewhere in the contract, the Design-Build Team shall furnish all implements, machinery, equipment, tools, materials, supplies, transportation, and labor necessary for the design, prosecution and completion of the work.

Page 1-31, Article 104-3, replace “plans or details of construction” with “contract” in all instances within this Article.

Page 1-40, Article 104-10, replace the first paragraph with the following:

104-10 MAINTENANCE OF THE PROJECT

The Design-Build Team shall maintain the project from the date of beginning construction on the project until the project is finally accepted. For sections of facilities impacted by utility construction / relocation performed by the Design-Build Team prior to beginning construction on the roadway project, maintenance of the impacted sections of facilities shall be performed by the Design-Build Team beginning concurrently with the impact. All existing and constructed guardrail / guiderail within the project limits shall be included in this maintenance. This maintenance shall be continuous and effective and shall be prosecuted with adequate equipment and forces to the end that all work covered by the contract is kept in satisfactory and acceptable conditions at all times. The Design-Build Team shall perform weekly inspections of guardrail and guiderail and shall report damages to the Engineer on the same day of the weekly inspection. Where damaged guardrail or guiderail is repaired or replaced as a result of maintaining the project in accordance with this Article, such repair or replacement shall be performed within 7 consecutive calendar days of such inspection report.

Page 1-41, Article 104-10, add the following after the last paragraph:

The Design-Build Team will not be compensated for performance of weekly inspections and damage reports for the guardrail / guiderail. Other maintenance activities for existing guardrail / guiderail will be handled in accordance with Articles 104-7 and 104-8.

SECTION 105 CONTROL OF WORK

Pages 1-46, delete Article 105-2 and replace with the following:

105-2 PLANS AND WORKING DRAWINGS

All plans shall be supplemented by such approved working drawings as are necessary to adequately control the work. Working drawings furnished by the Design-Build Team and approved by the Engineer shall consist of such detailed drawings as may be required to adequately control the work. They may include stress sheets, shop drawings, erection drawings, falsework drawings, cofferdam drawings, bending diagrams for reinforcing steel, catalog cuts, or any other supplementary drawings or similar data required of the Design-Build Team. When working drawings are approved by the Engineer, such approval shall not operate to relieve the Design-Build Team of any of his responsibility under the contract for the successful completion of the work.

Changes on shop drawings after approval and/or distribution shall be subject to the approval of the Engineer and he shall be furnished a record of such changes.

Page 1-47, Article 105-3, add the following after the 3rd paragraph:

The Design-Build Team shall bear all the costs of providing the burden of proof that the nonconforming work is reasonable and adequately addresses the design purpose. The Design-Build Team shall bear all risk for continuing with nonconforming work in question until it is accepted.

The Engineer may impose conditions for acceptance of the nonconforming work. The Design-Build Team shall bear all costs for fulfilling the conditions.

The decisions whether the product satisfies the design purpose, whether the nonconforming work is reasonably acceptable and the conditions for acceptance are at the sole discretion of the Engineer.

Pages 1-47, delete Article 105-4 and replace with the following:

105-4 COORDINATION OF PLANS, SPECIFICATIONS, SUPPLEMENTAL SPECIFICATIONS, AND SPECIAL PROVISIONS

The Request for Proposals, all Plans, the Standard Specifications, and all supplementary documents are essential parts of the contract and a requirement occurring in one is as binding as though occurring in all. They are intended to be complementary and to describe and provide for a complete work.

In case of discrepancy or conflict, the order in which they govern shall be as follows:

- (A) Request for Proposals
- (B) Technical Proposal from the Design-Build Team
- (C) Accepted Plans and Details from the Design-Build Team, or sealed plans provided by the Department, as applicable
- (D) Standard Drawings

(E) Standard Specifications

Where dimensions on the plans are given or can be computed from other given dimensions they shall govern over scaled dimensions.

The Design-Build Team shall take no advantage of any error or omission in the plans, estimated quantities, or specifications. In the event the Design-Build Team discovers an error or omission, he shall immediately notify the Engineer.

Page 1-50, delete Article 105-9 and replace with the following:

105-9 CONSTRUCTION STAKES, LINES, AND GRADES

The Design-Build Team shall be responsible for any surveying, construction staking and layout required in the performance of the work. He will be responsible for the accuracy of lines, slopes, grades and other engineering work which he provides under this contract. Unless otherwise specified in the Request for Proposals, no measurement or direct payment will be made for this work. The cost shall be considered as included in other contract items.

**SECTION 106
CONTROL OF MATERIAL**

Page 1-56, Article 106-2, add the following after the second paragraph:

Prior to beginning construction, the Design-Build Team shall provide a Table of Quantities as described in Article 101-3 of these specifications.

The Table of Quantities Work Items shall correspond to Pay Items as defined in the Standard Specifications. These Work Items have associated Materials and Conversion Factors. For non-standard Work Items, a Generic Work Item with the correct Unit of Measure and in an appropriate category will be used. For example, “GENERIC TRAFFIC CONTROL ITEM – EA” or “GENERIC RETAINING WALL ITEM – LF”. For these Generic Work Items, Materials must be defined and appropriate conversion factors submitted.

An initial Table of Quantities shall be submitted no later than 30 calendar days after the date of award. The Table of Quantities shall be updated and resubmitted within 14 days of when a set of Plans is sealed as Release for Construction (RFC) Plans, and whenever there are substantial changes to the Quantities on previously incorporated RFC Plans.

Page 1-58, Article 106-6, replace “specifications” with “contract” as the last word of the 1st paragraph.

Page 1-58, Article 106-6(C), replace the 2nd paragraph with the following:

Where the Department agrees to inspect or test materials during their production or at the source of supply, the Design-Build Team shall bear the cost of testing performed on materials ordered by him but not incorporated into the project. For items normally pretested by the Department, the Design-Build Team shall provide a minimum of 30 days notice prior to the beginning of production of the items for this project along with final approved shop drawings.

**SECTION 107
LEGAL RELATIONS AND RESPONSIBILITY
TO PUBLIC**

Page 1-60, Article 107-2, delete the entire article and replace with the following:

In accordance with G.S. 143B-426.40A, the Department will not recognize any assignment of claims by any Contractor against the Department.

Page 1-69, Article 107-18, in the last sentence of the first paragraph, replace the word “legally” with the word “contractually”.

Page 1-69, delete Article 107-19 and replace with the following:

107-19 FURNISHING RIGHT OF WAY

The responsibility for coordinating the securing of all necessary rights of way is as outlined in the Request for Proposals.

**SECTION 108
PROSECUTION AND PROGRESS**

Page 1-71, Article 108-1, add the following sentence to the end of the 1st paragraph:

The Design-Build Team shall not commence work prior to execution of the contract by both the Department and the Design-Build Team.

Page 1-72, delete Article 108-3 and replace with the following:

108-3 PRECONSTRUCTION AND PRE-DESIGN CONFERENCES

The selected Design-Build Team shall meet with the Engineer for a pre-design conference concerning the design phase of the work. This conference shall be held prior to the commencement of work, as it is determined according to Article 108-1, and will be scheduled by the Engineer. At the predesign conference, the Design-Build Team shall furnish authorized signature forms and a list of any proposed subcontractors associated with the design of the project.

A preconstruction conference shall be held at least 10 working days before construction activity begins. This second conference, concerning the construction phase, shall also be scheduled by the Engineer. The Design-Build Team shall give the Engineer a minimum of 45 days notice before he plans to begin construction activities. This will allow the Engineer time for any environmental agency representatives involved in the permitting process, as well as any other pertinent entities, to be scheduled to attend the preconstruction conference. If the Design-Build Team is responsible for utilities in accordance with Article 105-8 and the Request for Proposals, he shall be responsible for coordinating with the Engineer in scheduling their attendance and for notifying them. The Design-Build Team shall also be responsible for

coordinating with the Engineer in scheduling the attendance of subcontractors and others deemed appropriate, and for notifying them.

At the preconstruction conference, a list of any proposed subcontractors and major material suppliers associated with the construction of the project will be submitted.

If the contract has a DBE requirement, the Design-Build Team shall submit copies of completed and signed DBE subcontracts, purchase orders, or invoices to the Department.

The Design-Build Team shall submit a traffic control plan in accordance with Article 1101-5 and the Request for Proposals. The Design-Build Team shall designate an employee who is competent and experienced in traffic control to implement and monitor the traffic control plan. The qualifications of the designated employee must be satisfactory to the Engineer.

The Design-Build Team shall submit a safety plan and designate an employee as Safety Supervisor.

Both plans shall be submitted at the preconstruction conference and must be satisfactory to the Engineer. Should the design plan include activities that would place personnel on the work site, traffic control and safety plans for those activities shall be submitted at the predesign conference.

During the preconstruction conference, the Engineer will designate a Department employee or employees who will be responsible to see that the traffic control plans and any alterations thereto are implemented and monitored to the end that traffic is carried through the work in an effective manner. If approved by the Engineer, the Design-Build Team may designate one employee to be responsible for both the traffic control and safety plans. The Design-Build Team shall not designate its superintendent as the responsible person for either the traffic control plan or the safety plan, unless approved by the Engineer.

If the project requires that Design-Build Team or State personnel work from falsework, within shoring, or in any other hazardous area the Design-Build Team shall submit, as part of the Design-Build Team's safety plan, specific measures it will use to ensure worker safety.

The Design-Build Team shall also submit a program for erosion control and pollution prevention on all projects involving clearing and grubbing, earthwork, structural work, or other construction, when such work is likely to create erosion or pollution problems.

If the Design-Build Team fails to provide the required submissions, the Engineer may order the preconstruction conference suspended until such time as they are furnished. Work shall not begin until the preconstruction conference has been concluded and the safety plan has been approved, unless authorized by the Engineer. The Design-Build Team shall not be entitled to additional compensation or an extension of contract time resulting from any delays due to such a suspension.

The Design-Build Team shall designate a qualified employee as Quality Control Manager. The Quality Control Manager shall be responsible for implementing and monitoring the quality control requirements of the project.

Page 1-72, Article 108-4, add the following sentence to the end of this article:

The Design-Build Team shall record the proceedings of these conferences and distribute the final minutes of the conferences to all attendees.

Page 1-74, Article 108-6, replace “40 percent” with “30 percent” in the 1st paragraph.

Page 1-74, Article 108-6, delete the second paragraph and replace with the following:

In any event, the Contractor shall perform with his own organization work amounting to not less than 25% of the difference between the total amount bid and the value of specialty items that have been sublet.

Pages 1-75, delete Article 108-8 and replace with the following:

108-8 FAILURE TO MAINTAIN SATISFACTORY PROGRESS

The Engineer will check the Design-Build Team’s progress at the time each partial pay request is received. The Design-Build Team’s progress may be considered as unsatisfactory if, according to the Progress schedule, the projected finish date for all work exceeds the scheduled finish date by more than 10%.

When the Design-Build Team's progress is found to be unsatisfactory as described above, the Engineer may make written demand of the Design-Build Team to state in writing the reason for the unsatisfactory progress and produce such supporting data as the Engineer may require or the Design-Build Team may desire to submit. The Engineer will consider the justifications submitted by the Design-Build Team and extensions of the completion date that have or may be allowed in accordance with Article 108-10(B).

When the Design-Build Team cannot satisfactorily justify the unsatisfactory progress the Engineer may invoke one or more of the following sanctions:

1. Withhold anticipated liquidated damages from amounts currently due or which become due.
2. Remove the Design-Build Team and individual managing firms of the Design-Build Team and/or prequalified design firms from the Department’s Prequalified Bidders List.

When any of the above sanctions have been invoked, they shall remain in effect until rescinded by the Engineer.

Page 1-79, Article 108-10(B), add the following as the first paragraph:

Only delays to activities which affect the completion date or intermediate contract date will be considered for an extension of contract time. No extensions will be granted until a delay occurs which impacts the project’s critical path and extends the work beyond the contract completion date or intermediate completion date. Any extension to the completion date or intermediate contract date will be based on the number of calendar days the completion date or intermediate completion date is impacted as determined by the Engineer’s analysis.

Pages 1-79, delete Subarticle 108-10(B)(1) in its entirety.

Page 1-83, Article 108-13, delete bullet (E)(2) in its entirety.

SECTION 109 MEASUREMENT AND PAYMENT

Page 1-85, Article 109-2, delete the last sentence of the 1st paragraph and replace with the following:

Payment to the Design-Build Team will be made only for the work completed, certified and accepted in accordance with the terms of the contract.

Pages 1-90, delete Article 109-4(A) and replace with the following:

109-4 PARTIAL PAYMENTS

(A) General:

Partial payments will be based upon progress estimates prepared by the Engineer at least once each month on the date established by the Engineer. Partial payments may be made twice each month if in the judgment of the Engineer the amount of work performed is sufficient to warrant such payment. No partial payment will be made when the total value of work performed since the last partial payment amounts to less than \$10,000.00. Partial payments will be approximate only and will be subject to correction in the final estimate and payment.

When the contract includes one lump sum price for the entire work required by the contract, partial payments for the lump sum design-build price shall be based on a certified Schedule of Values submitted by the successful Design-Build Team and approved by the Engineer. The certification shall indicate the Design-Build Team has reviewed the information submitted and the information accurately represents the work performed for which payment is requested. The certified Schedule of Values shall be submitted no later than 30 calendar days after the date of award. Each item on the certified Schedule of Values shall be assigned a cost and quantity and shall be identified as an activity on the progress schedule. A revised certified Schedule of Values shall be submitted with each update of the Progress schedule as described in Article 108-2 or when requested by the Engineer. A certified copy of the Table of Quantities shall also be submitted with each payment request. The certification of the Table of Quantities shall indicate the Design-Build Team has reviewed the information submitted and the information accurately represents the materials for the work performed for which payment is requested.

When the contract includes lump sum items for portions of the work required by the contract, and the applicable section of the Specifications or Request for Proposals specify the means by which the total amount bid be included in the partial pay estimates, the Engineer will determine amounts due on the partial pay estimate in accordance with the applicable portion of the Specifications or Request for Proposals.

The Engineer will withhold an amount sufficient to cover anticipated liquidated damages as determined by the Engineer.

Page 1-92, Subarticle 109-5(D), delete the 4th and 5th paragraphs and replace with the following:

Partial payments will not be made on seed or any living or perishable plant materials.

Partial payment requests shall not be submitted by the Design-Build Team until those items requested have corresponding signed and sealed RFC plans accepted by the Department.

Pages 1-94, Article 109-10, add the following as bullets (E) and (F) under the 1st paragraph.

- (E) As-constructed plans or other submittals as required by the Contract.
- (G) Documents or guarantees to support any warranty provided by the Design Build Team.

County : Davidson

Line #	Item Number	Sec #	Description	Quantity	Unit Cost	Amount
--------	-------------	-------	-------------	----------	-----------	--------

ROADWAY ITEMS

0001	0000900000-N	SP	GENERIC MISCELLANEOUS ITEM DESIGN AND CONSTRUCTION	Lump Sum	L.S.	
------	--------------	----	---	----------	------	--

1023/Jun08/Q1.0/D900000/E1

Total Amount Of Bid For Entire Project :

FUEL USAGE FACTOR CHART AND ESTIMATE OF QUANTITIES

Description of Work	Units	Fuel Usage Factor Diesel #2	Estimate of Quantities
Unclassified Excavation	Gal / CY	0.29	_____ CY
Borrow Excavation	Gal / CY	0.29	_____ CY
Aggregate Base Course Aggregate for Cement Treated Base Course Portland Cement for Cement Treated Base Course	Gal / Ton	0.55	_____ Tons
Asphalt Concrete Base Course Asphalt Concrete Intermediate Course Asphalt Concrete Surface Course Open-Graded Asphalt Friction Course Sand Asphalt Surface Course, Type F-1	Gal / Ton	2.90	_____ Tons
Portland Cement Concrete Pavement Structural Concrete (cast-in-place only) Concrete Shoulders Adjacent to Pavement	Gal / CY	0.98	_____ CY

The above quantities represent a reasonable estimate of the total quantities anticipated, for each item, as pertaining to fuel price adjustments, and is representative of the design proposed in the Technical Proposal submitted under separate cover.

Or

The Design-Build Team elects not to pursue reimbursement for Fuel Price Adjustments on this project.

The information submitted on this sheet is claimed as a “Trade Secret” in accordance with the requirements of G.S. 66-152(3) until such time as the Price Proposal is opened.

Signature, Title

Dated

Print Name, Title

(Submit a copy of this sheet in a separate sealed package with the outer wrapping clearly marked “Fuel Price Adjustment” and deliver with the Technical and Cost Proposal.)

**EXECUTION OF BID
NON-COLLUSION AFFIDAVIT, DEBARMENT CERTIFICATION AND GIFT BAN CERTIFICATION**

CORPORATION

The person executing the bid, on behalf of the Bidder, being duly sworn, solemnly swears (or affirms) that neither he, nor any official, agent or employee of the bidder has entered into any agreement, participated in any collusion, or otherwise taken any action which is in restraint of free competitive bidding in connection with any bid or contract, that the bidder has not been convicted of violating *N.C.G.S. § 133-24* within the last three years, and that the Bidder intends to do the work with its own bonafide employees or subcontractors and is not bidding for the benefit of another contractor.

In addition, execution of this bid in the proper manner also constitutes the Bidder's certification of status under penalty of perjury under the laws of the United States in accordance with the Debarment Certification attached, provided that the Debarment Certification also includes any required statements concerning exceptions that are applicable.

N.C.G.S. § 133-32 and Executive Order 24 prohibit the offer to, or acceptance by, any State Employee of any gift from anyone with a contract with the State, or from any person seeking to do business with the State. By execution of any response in this procurement, you attest, for your entire organization and its employees or agents, that you are not aware that any such gift has been offered, accepted, or promised by any employees of your organization.

SIGNATURE OF CONTRACTOR

_____ Full name of Corporation

_____ Address as prequalified

Attest _____
Secretary/Assistant Secretary
Select appropriate title

By _____
President/Vice President/Assistant Vice President
Select appropriate title

_____ Print or type Signer's name

_____ Print or type Signer's name

CORPORATE SEAL

AFFIDAVIT MUST BE NOTARIZED

Subscribed and sworn to before me this the
_____ day of _____, 20_____

_____ Signature of Notary Public
Of _____ County
State of _____
My Commission Expires _____

NOTARY SEAL

**EXECUTION OF BID
NON-COLLUSION AFFIDAVIT, DEBARMENT CERTIFICATION AND GIFT BAN CERTIFICATION**

PARTNERSHIP

The person executing the bid, on behalf of the Bidder, being duly sworn, solemnly swears (or affirms) that neither he, nor any official, agent or employee of the bidder has entered into any agreement, participated in any collusion, or otherwise taken any action which is in restraint of free competitive bidding in connection with any bid or contract, that the bidder has not been convicted of violating *N.C.G.S. § 133-24* within the last three years, and that the Bidder intends to do the work with its own bonafide employees or subcontractors and is not bidding for the benefit of another contractor.

In addition, execution of this bid in the proper manner also constitutes the Bidder's certification of status under penalty of perjury under the laws of the United States in accordance with the Debarment Certification attached, provided that the Debarment Certification also includes any required statements concerning exceptions that are applicable.

N.C.G.S. § 133-32 and Executive Order 24 prohibit the offer to, or acceptance by, any State Employee of any gift from anyone with a contract with the State, or from any person seeking to do business with the State. By execution of any response in this procurement, you attest, for your entire organization and its employees or agents, that you are not aware that any such gift has been offered, accepted, or promised by any employees of your organization.

SIGNATURE OF CONTRACTOR

Full Name of Partnership

Address as Prequalified

By

Signature of Witness

Signature of Partner

Print or type Signer's name

Print or type Signer's name

AFFIDAVIT MUST BE NOTARIZED

Subscribed and sworn to before me this the
day of _____ 20____.

Signature of Notary Public

of _____ County

State of _____

My Commission Expires: _____

NOTARY SEAL

**EXECUTION OF BID
NON-COLLUSION AFFIDAVIT, DEBARMENT CERTIFICATION AND GIFT BAN CERTIFICATION**

LIMITED LIABILITY COMPANY

The person executing the bid, on behalf of the Bidder, being duly sworn, solemnly swears (or affirms) that neither he, nor any official, agent or employee of the bidder has entered into any agreement, participated in any collusion, or otherwise taken any action which is in restraint of free competitive bidding in connection with any bid or contract, that the bidder has not been convicted of violating *N.C.G.S. § 133-24* within the last three years, and that the Bidder intends to do the work with its own bonafide employees or subcontractors and is not bidding for the benefit of another contractor.

In addition, execution of this bid in the proper manner also constitutes the Bidder's certification of status under penalty of perjury under the laws of the United States in accordance with the Debarment Certification attached, provided that the Debarment Certification also includes any required statements concerning exceptions that are applicable.

N.C.G.S. § 133-32 and Executive Order 24 prohibit the offer to, or acceptance by, any State Employee of any gift from anyone with a contract with the State, or from any person seeking to do business with the State. By execution of any response in this procurement, you attest, for your entire organization and its employees or agents, that you are not aware that any such gift has been offered, accepted, or promised by any employees of your organization.

SIGNATURE OF CONTRACTOR

_____ Full Name of Firm

_____ Address as Prequalified

Signature of Member/Manager

_____ Individually

_____ Print or type Signer's Name

AFFIDAVIT MUST BE NOTARIZED

Subscribed and sworn to before me this the
_____ day of _____ 20__.

Signature of Notary Public
of _____ County
State of _____
My Commission Expires: _____

NOTARY SEAL

EXECUTION OF BID
NON-COLLUSION AFFIDAVIT, DEBARMENT CERTIFICATION AND GIFT BAN CERTIFICATION
JOINT VENTURE (2) or (3)

The person executing the bid, on behalf of the Bidder, being duly sworn, solemnly swears (or affirms) that neither he, nor any official, agent or employee of the bidder has entered into any agreement, participated in any collusion, or otherwise taken any action which is in restraint of free competitive bidding in connection with any bid or contract, that the bidder has not been convicted of violating N.C.G.S. § 133-24 within the last three years, and that the Bidder intends to do the work with its own bonafide employees or subcontractors and is not bidding for the benefit of another contractor.

In addition, execution of this bid in the proper manner also constitutes the Bidder's certification of status under penalty of perjury under the laws of the United States in accordance with the Debarment Certification attached, provided that the Debarment Certification also includes any required statements concerning exceptions that are applicable.

N.C.G.S. § 133-32 and Executive Order 24 prohibit the offer to, or acceptance by, any State Employee of any gift from anyone with a contract with the State, or from any person seeking to do business with the State. By execution of any response in this procurement, you attest, for your entire organization and its employees or agents, that you are not aware that any such gift has been offered, accepted, or promised by any employees of your organization.

SIGNATURE OF CONTRACTORS

Instructions: 2 Joint Venturers Fill in lines (1), (2) and (3) and execute. 3 Joint Venturers Fill in lines (1), (2), (3) and (4) and execute. On Line (1), fill in the name of the Joint Venture Company. On Line (2), fill in the name of one of the joint venturers and execute below in the appropriate manner. On Line (3), print or type the name of the other joint venturer and execute below in the appropriate manner. On Line (4), fill in the name of the third joint venturer, if applicable and execute below in the appropriate manner.

(1) Name of Joint Venture

(2) Name of Contractor

Address as prequalified

Signature of Witness or Attest By Signature of Contractor
Print or type Signer's name Print or type Signer's name
If Corporation, affix Corporate Seal and

(3) Name of Contractor

Address as prequalified

Signature of Witness or Attest By Signature of Contractor
Print or type Signer's name Print or type Signer's name
If Corporation, affix Corporate Seal and

(4) Name of Contractor (for 3 Joint Venture only)

Address as prequalified

Signature of Witness or Attest By Signature of Contractor
Print or type Signer's name Print or type Signer's name
If Corporation, affix Corporate Seal

NOTARY SEAL
Affidavit must be notarized for Line (2)

Subscribed and sworn to before me this
day of 20

Signature of Notary Public
of County
State of
My Commission Expires:

NOTARY SEAL
Affidavit must be notarized for Line (3)

Subscribed and sworn to before me this
day of 20

Signature of Notary Public
of County
State of
My Commission Expires:

NOTARY SEAL
Affidavit must be notarized for Line (4)

Subscribed and sworn to before me this
day of 20

Signature of Notary Public
of County
State of
My Commission Expires:

**EXECUTION OF BID
NON-COLLUSION AFFIDAVIT, DEBARMENT CERTIFICATION AND GIFT BAN CERTIFICATION**

INDIVIDUAL DOING BUSINESS UNDER A FIRM NAME

The person executing the bid, on behalf of the Bidder, being duly sworn, solemnly swears (or affirms) that neither he, nor any official, agent or employee of the bidder has entered into any agreement, participated in any collusion, or otherwise taken any action which is in restraint of free competitive bidding in connection with any bid or contract, that the bidder has not been convicted of violating *N.C.G.S. § 133-24* within the last three years, and that the Bidder intends to do the work with its own bonafide employees or subcontractors and is not bidding for the benefit of another contractor.

In addition, execution of this bid in the proper manner also constitutes the Bidder's certification of status under penalty of perjury under the laws of the United States in accordance with the Debarment Certification attached, provided that the Debarment Certification also includes any required statements concerning exceptions that are applicable.

N.C.G.S. § 133-32 and Executive Order 24 prohibit the offer to, or acceptance by, any State Employee of any gift from anyone with a contract with the State, or from any person seeking to do business with the State. By execution of any response in this procurement, you attest, for your entire organization and its employees or agents, that you are not aware that any such gift has been offered, accepted, or promised by any employees of your organization.

SIGNATURE OF CONTRACTOR

Name of Contractor

_____ Individual name

Trading and doing business as

_____ Full name of Firm

_____ Address as Prequalified

_____ Signature of Witness

_____ Signature of Contractor, Individually

_____ Print or type Signer's name

_____ Print or type Signer's name

AFFIDAVIT MUST BE NOTARIZED

Subscribed and sworn to before me this the
____ day of _____ 20__.

Signature of Notary Public
of _____ County
State of _____
My Commission Expires: _____

NOTARY SEAL

**EXECUTION OF BID
NON-COLLUSION AFFIDAVIT, DEBARMENT CERTIFICATION AND GIFT BAN CERTIFICATION**

INDIVIDUAL DOING BUSINESS IN HIS OWN NAME

The person executing the bid, on behalf of the Bidder, being duly sworn, solemnly swears (or affirms) that neither he, nor any official, agent or employee of the bidder has entered into any agreement, participated in any collusion, or otherwise taken any action which is in restraint of free competitive bidding in connection with any bid or contract, that the bidder has not been convicted of violating *N.C.G.S. § 133-24* within the last three years, and that the Bidder intends to do the work with its own bonafide employees or subcontractors and is not bidding for the benefit of another contractor.

In addition, execution of this bid in the proper manner also constitutes the Bidder's certification of status under penalty of perjury under the laws of the United States in accordance with the Debarment Certification attached, provided that the Debarment Certification also includes any required statements concerning exceptions that are applicable.

N.C.G.S. § 133-32 and Executive Order 24 prohibit the offer to, or acceptance by, any State Employee of any gift from anyone with a contract with the State, or from any person seeking to do business with the State. By execution of any response in this procurement, you attest, for your entire organization and its employees or agents, that you are not aware that any such gift has been offered, accepted, or promised by any employees of your organization.

SIGNATURE OF CONTRACTOR

Name of Contractor _____
Print or type Individual name

Address as Prequalified

Signature of Contractor, Individually

Print or type Signer's Name

Signature of Witness

Print or type Signer's name

AFFIDAVIT MUST BE NOTARIZED

Subscribed and sworn to before me this the
____ day of _____ 20__.

Signature of Notary Public
of _____ County
State of _____
My Commission Expires: _____

NOTARY SEAL

DEBARMENT CERTIFICATION

Conditions for certification:

1. The prequalified bidder shall provide immediate written notice to the Department if at any time the bidder learns that his certification was erroneous when he submitted his debarment certification or explanation that is file with the Department, or has become erroneous because of changed circumstances.
2. The terms *covered transaction, debarred, suspended, ineligible, lower tier covered transaction, participant, person, primary covered transaction, principal, proposal, and voluntarily excluded*, as used in this provision, have the meanings set out in the Definitions and Coverage sections of the rules implementing Executive Order 12549. A copy of the Federal Rules requiring this certification and detailing the definitions and coverages may be obtained from the Contract Officer of the Department.
3. The prequalified bidder agrees by submitting this form, that he will not knowingly enter into any lower tier covered transaction with a person who is debarred, suspended, declared ineligible, or voluntarily excluded from participation in NCDOT contracts, unless authorized by the Department.
4. For Federal Aid projects, the prequalified bidder further agrees that by submitting this form he will include the Federal-Aid Provision titled *Required Contract Provisions Federal-Aid Construction Contract (Form FHWA PR 1273)* provided by the Department, without subsequent modification, in all lower tier covered transactions.
5. The prequalified bidder may rely upon a certification of a participant in a lower tier covered transaction that he is not debarred, suspended, ineligible, or voluntarily excluded from the covered transaction, unless he knows that the certification is erroneous. The bidder may decide the method and frequency by which he will determine the eligibility of his subcontractors.
6. Nothing contained in the foregoing shall be construed to require establishment of a system of records in order to render in good faith the certification required by this provision. The knowledge and information of a participant is not required to exceed that which is normally possessed by a prudent person in the ordinary course of business dealings.
7. Except as authorized in paragraph 6 herein, the Department may terminate any contract if the bidder knowingly enters into a lower tier covered transaction with a person who is suspended, debarred, ineligible, or voluntarily excluded from participation in this transaction, in addition to other remedies available by the Federal Government.

DEBARMENT CERTIFICATION

The prequalified bidder certifies to the best of his knowledge and belief, that he and his principals:

- a. Are not presently debarred, suspended, proposed for debarment, declared ineligible, or voluntarily excluded from covered transactions by any Federal department or agency;
- b. Have not within a three-year period preceding this proposal been convicted of or had a civil judgment rendered against them for commission of fraud or a criminal offense in connection with obtaining, attempting to obtain, or performing a public (Federal, State or local) transaction or contract under a public transaction; violation of Federal or State antitrust statutes or commission of embezzlement, theft, forgery, bribery, falsification or destruction of records; making false statements; or receiving stolen property;
- c. Are not presently indicted for or otherwise criminally or civilly charged by a governmental entity (Federal, State or local) with commission of any of the offenses enumerated in paragraph b. of this certification; and
- d. Have not within a three-year period preceding this proposal had one or more public transactions (Federal, State or local) terminated for cause or default.
- e. Will submit a revised Debarment Certification immediately if his status changes and will show in his bid proposal an explanation for the change in status.

If the prequalified bidder cannot certify that he is not debarred, he shall provide an explanation with this submittal. An explanation will not necessarily result in denial of participation in a contract.

Failure to submit a non-collusion affidavit and debarment certification will result in the prequalified bidder's bid being considered non-responsive.

Check here if an explanation is attached to this certification.

Contract No **C 202382**

County (ies): **Davidson**

ACCEPTED BY THE
DEPARTMENT OF TRANSPORTATION

Contract Officer

Date

Execution of Contract and Bonds
Approved as to Form:

Attorney General